

User's Manual

FlexScan[®] L371/L671

Color LCD Monitor



SAFETY SYMBOLS

This manual uses the safety symbols below. They denote critical information. Please read them carefully.



WARNING

Failure to abide by the information in a WARNING may result in serious injury and can be life threatening.



CAUTION

Failure to abide by the information in a CAUTION may result in moderate injury and/or property or product damage.



Indicates a prohibited action.



Indicates to ground for safety.

Copyright© 2000 by EIZO NANA0 CORPORATION. All rights reserved. No part of this manual may be reproduced, stored in a retrieval system, or transmitted, in any form or by any means, electronic, mechanical, or otherwise, without the prior written permission of Eizo Nanao Corporation.

Eizo Nanao Corporation is under no obligation to hold any submitted material or information confidential unless prior arrangements are made pursuant to Eizo Nanao Corporation's receipt of said information. Although every effort has been made to ensure that this manual provides up-to-date information, please note that EIZO monitor specifications are subject to change without notice.

ENERGY STAR is a U.S. registered mark.

Apple and Macintosh are registered trademarks of Apple Computer, Inc.

VGA is a registered trademark of International Business Machines Corporation.

DPMS is a trademark and VESA is a registered trademark of Video Electronics Standards Association.

Windows is a registered trademark of Microsoft Corporation.

ScreenManager, PowerManager and i-Sound are trademarks of Eizo Nanao Corporation.

FlexScan and EIZO are registered trademarks of Eizo Nanao Corporation.



As an ENERGY STAR® Partner, Eizo Nanao Corporation has determined that this product meets the ENERGY STAR guidelines for energy efficiency.

TABLE OF CONTENTS

 PRECAUTIONS	4
1. INTRODUCTION	10
1-1. Features	10
1-2. Package Contents	11
1-3. Controls & Connectors	12
2. CABLE CONNECTION	14
2-1. Before connecting	14
2-2. Connecting up	15
2-3. Digital input connection	17
3. ScreenManager	18
3-1. How to use the ScreenManager	18
3-2. ScreenManager Adjustments and Settings	19
3-3. Useful Functions	20
4. ADJUSTMENT	21
4-1. Screen Adjustment	21
4-2. Displaying the low resolutions	25
4-3. Color adjustment	27
4-4. Power-save Setup	28
5. ADJUSTMENT FOR DIGITAL	29
5-1. Screen Adjustment	29
5-2. Displaying the low resolutions	30
5-3. Power-save Setup	31
6. MAKING USE OF USB (Universal Serial Bus)	32
7. CONNECTING TWO PCs to THE MONITOR	34
8. ATTACHING AN ARM STAND	36
9. TROUBLE SHOOTING	38
10. CLEANING	42
11. SPECIFICATIONS	43
12. GLOSSARY	46
13. INDEX	48

PRECAUTIONS

IMPORTANT!

- ⌞ This product has been adjusted specifically for use in the region to which it was originally shipped. If operated outside the region to which it was originally shipped, the product may not perform as stated in the specifications.
- ⌞ To ensure personal safety and proper maintenance. Please read this section and the caution statements on the monitor (refer to the figure below).

[Location of the Caution Statements]

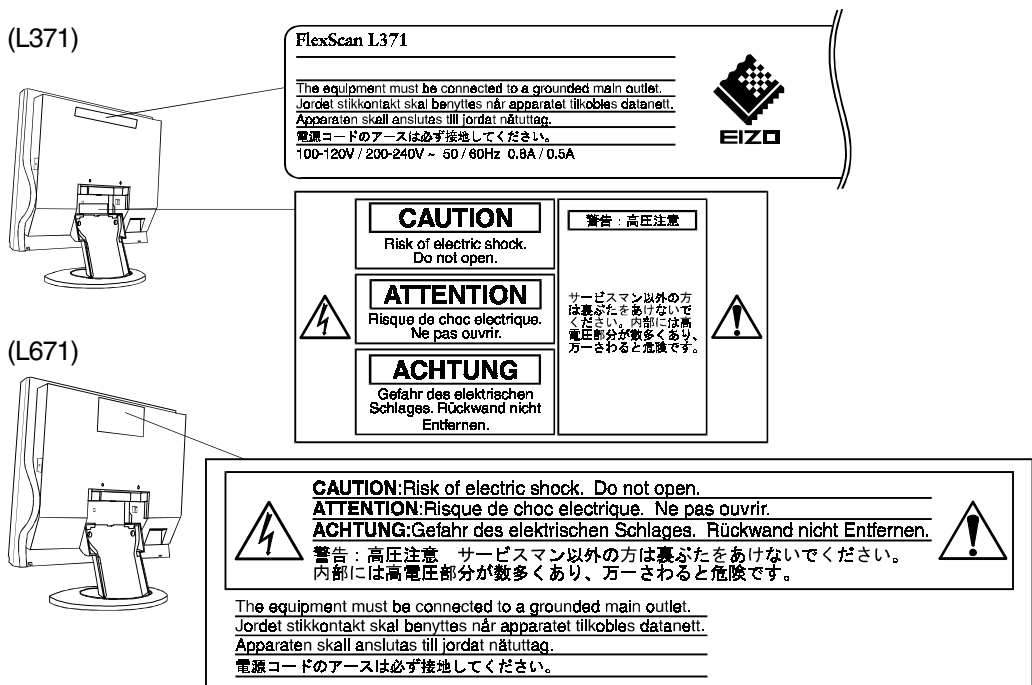

WARNING

- ⌞ **If the monitor begins to emit smoke, smells like something is burning, or makes strange noises, disconnect all power connections immediately and contact your dealer for advice.**
Attempting to use a malfunctioning monitor can be dangerous.
- ⌞ **Do not dismantle the cabinet or modify the monitor.**
Dismantling the cabinet or modifying the monitor may result in electric shock or burn.
- ⌞ **Refer all servicing to qualified service personnel.**
Do not attempt to service this product yourself as opening or removing covers may expose you to dangerous voltage or other hazards.



WARNING

- **Keep small objects away from the monitor.**

Small objects may accidentally fall through the ventilation slots into the cabinet, leading to fire, shock, or equipment damage.

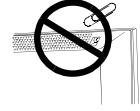

- **Keep liquids away from the monitor.**

Spillage into the cabinet may result in fire, electric shock, or equipment damage. If an object or liquid falls/spills into the cabinet, unplug the monitor immediately. Have the monitor checked by a qualified service engineer before using it again.



- **Place the monitor on a strong, stable surface.**

A monitor placed on an inadequate surface may fall, resulting in injury or equipment damage. If the monitor falls, disconnect the power immediately and have the monitor checked by a qualified service engineer before using it again. Using a monitor after it has been dropped may result in fire or electric shock.

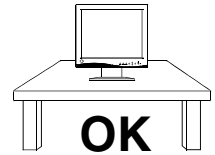

- **Set the monitor in an appropriate location.**

- * Do not install in a dusty or humid environment.
- * Do not place in a location where steam can have direct contact with the screen.
- * Do not place near heat generating devices or a humidifier.

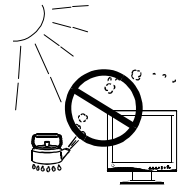

- **Keep the plastic packing bags away from children and infants.**

Plastic bags can be dangerous. To avoid danger of suffocation, keep the bag away from babies and children.



- **Keep power terminal covers for the optional *i-Sound*™ sound unit away from children and infants.**

Children and infants may accidentally swallow the covers and choke. If swallowed, consult a doctor immediately.

WARNING

- **Use the enclosed power cord. If using the power cord other than the enclosed one, follow these guidelines.**

[USA and Canada]

Use a UL LISTED/CSA LABELED or CERTIFIED power cord set meeting the following specifications.

- * Rating: min. 125 V, 10 A * Length: max. 2.0 m
- * Plug type: NEMA 5-15P, Parallel blade, Grounding type, 125 V, 10 A
- * Type: SVT

[Europe]

Use a proper European standard approved power cord meeting the following specifications.

- * Rating: min. 250 V, 10 A * Length: max. 2.0 m
- * Type: H05VV-F 3G 1 mm²

Use a plug type approved by the country where you reside. Failure to do so may cause fire or electric shock.

- **To disconnect the power cord, grasp the plug firmly and pull.**

Never tug on the cord, doing so may cause damage and could result in fire or electric shock.



- **The equipment must be connected to a grounded main outlet.**



- **Use the correct voltage.**

- * The monitor is designed for use with a specific voltage only. Connection to a different voltage may cause fire, electric shock, or other damage.
- * Do not overload your power circuit, as this may result in fire or electric shock.
- * For proper connections of the power cord, be certain to plug the power cord to the provided monitor connector and directly to a wall outlet. Not doing so may result in fire or electric shock.

- **Handle the power cord with care.**

- * Do not place the cord underneath the monitor or other heavy objects.
- * Do not pull on the cord.
- * Do not attempt to repair a damaged cord.

If the power cord becomes damaged, stop using it. Use of a damaged cord may result in fire or electric shock.



- **Never touch the plug and power cord if it begins to thunder.**

If it begins to thunder, do not touch the plug, power cord or cable. Touching them may result in electric shock.

WARNING

✓ **Install the monitor securely when attaching to an arm stand.**

When attaching an arm stand, please refer to the user's manual of the arm stand and install the monitor securely with the enclosed screws. Not doing so may cause the monitor to come unattached, which may result in injury or equipment damage. When the monitor is dropped, please ask your dealer for advice. Do not continue using a damaged monitor. Using a damaged monitor may result in fire or electric shock.

When reattaching the tilt stand, please use the same screws and tighten them securely.

✓ **Do not touch a damaged LCD panel directly with bare hands.**

Use protective gloves whenever handling a damaged panel. The liquid crystal which leaks from the panel is poisonous if it enters the eyes or mouth. If any part of the skin or body comes in direct contact with the panel, please wash thoroughly. If some physical symptoms result, please consult your doctor.



✓ **Take care when disposing of the monitor.**

The backlight of the LCD panel contains mercury. Follow local regulation or laws for safe disposal.

CAUTION

• **Handle with care when carrying the monitor.**

- * Disconnect the power cord, signal cables and remove the optional *i-Sound*TM sound unit (if applicable). Moving the monitor with the cord attached or lifting it by the *i-Sound*TM sound unit is dangerous. It may result in injury or equipment damage.
- * When handling the monitor, grip the bottom of the monitor firmly with both hands ensuring the panel faces outward before lifting.
- * Handle with care to avoid scratching or damaging the panel. If the monitor becomes damaged, disconnect the power immediately and have the monitor checked by a qualified service engineer before using it again. Using a monitor after it has been dropped may result in fire or electric shock.

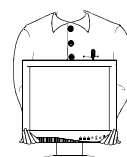

OK

CAUTION

⚠ **Do not block the ventilation slots on the cabinet.**

- * Do not place books or any other papers on the ventilation slots.
- * Do not install the monitor in a closed space.
- * Do not use the monitor lengthwise or upside down.

Using the monitor in this way blocks the ventilation slots and prevents proper airflow, leading to fire or other damage.



• **Do not use the LCD monitor outdoors or inside a car.**

This LCD monitor has been made specifically for indoor use as a desktop monitor. Using it anywhere else may result in fire, electrical shock, or other damage.

• **When adjusting the viewing angle of the monitor, do not do so by handling *i-Sound*[™] sound unit (if applicable).**

Adjusting the monitor in this way may break the monitor or cause bodily injury.

⚠ **At the end of the day or if you plan to leave the monitor unused for an extended period after turning off the power switch, disconnect the power cord from the wall socket so that no power connections are made.**

⚠ **Do not touch the plug with wet hands.**

Touching the plug with wet hands is dangerous and can cause electrical shock.



⚠ **Use an easily accessible power outlet.**

This will ensure that you can disconnect the power quickly in case of a problem.

⚠ **Unplug the monitor before cleaning it.**

Cleaning the monitor while it is plugged into a power outlet may result in electric shock.

⚠ **Never use thinner, benzene, alcohol (ethanol, methanol, or isopropyl alcohol), abrasive cleaners, or other strong solvents, as these may cause damage to the cabinet or LCD panel.**



⚠ **Periodically clean the area around the plug.**

Buildup of dust, water, or oil on the plug may result in fire.

Suggestions for Maximizing Comfort

- ˆ **To lessen the chance of possible injury and to increase your comfort and productivity while you operate the monitor, we suggest the following:**
 - * Avoid less favorable body positioning. Sit back on the chair with your back straight.
 - * Adjust the height of the chair so that the both soles touch the floor.
 - * Adjust the height of your chair, monitor, or keyboard so that you can keep your wrists straight while typing.
 - * Set the terminal slightly below eye level.
- ˆ **Adjust brightness of the screen depending on the brightness of your environment. Too dark or too bright of a screen can cause eye strain.**
- ˆ **Be sure to take adequate rests. A 10-minute rest period each hour is suggested.**
- **Do not remove the covers to the power terminal for the optional i-Sound™ sound unit for any reason except to attach the monitor.**

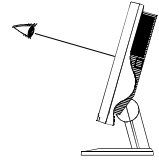

LCD Panel

- ˆ **The screen may have defective pixels. These pixels may appear as slightly light or dark area on the screen. This is due to the characteristics of the panel itself, and not the product.**
- ˆ **The backlight of the LCD panel has a fixed life span.**
When the screen becomes dark or begins to flicker, please contact your dealer.
- ˆ **Do not press on the panel or edge of the frame strongly, as this will result in damage to the screen. There will be prints left on the screen if the pressed image is dark or black. If pressure is repeatedly applied to the screen, it may deteriorate or damage your LCD panel. Leave the screen white to decrease the prints.**
- ˆ **Do not scratch or press on the panel with any sharp objects, such as a pencil or pen as this may result in damage to the panel. Do not attempt to brush with tissues as this may scratch the LCD panel.**



1. INTRODUCTION







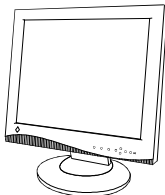
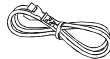

Thank you very much for choosing an EIZO Color Monitor.

1-1. Features

- DVI ^{p.46} Digital input (TMDS ^{p.47}) compliant.
- Dual inputs compliant (D-Sub mini 15 pin and DVI-I).
- L371: 1024 x 768 resolution
 - Horizontal scanning frequency of 27-61 kHz
 - Vertical scanning frequency of 50-85 Hz
 - Vertical (Digital) of 60 Hz (VGA text: 70 Hz)
- L671: 1280x 1024 resolution
 - Horizontal scanning frequency of 27-82 kHz
 - Vertical scanning frequency of 50-85 Hz
 - Vertical (Digital) of 60 Hz (VGA text: 70 Hz)
- Auto Adjustment compliant and original “Picture Adjustment Program” software included.
- Full screen mode and enlarged mode for lower resolutions incorporated.
- Smoothing function incorporated for the adjustment of an enlarged image.
- USB (Universal Serial Bus) hub supported.

1-2. Package Contents

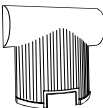
Please contact your local dealer for assistance if any of the listed items are missing or damaged.

- LCD Monitor 
- Power Cord 
- 4 of 4 mm x 12 mm mounting screws 
- EIZO LCD Utility Disk 
- Quick Reference 
- Signal Cable (MD-C87/C100) 
- Connector Cover 
- Rear Cover (attached to the monitor) 
- User's Manual 
- Warranty Registration Card 

NOTE

- Please retain the packing materials for future transference.

1-3. Controls & Connectors

Front

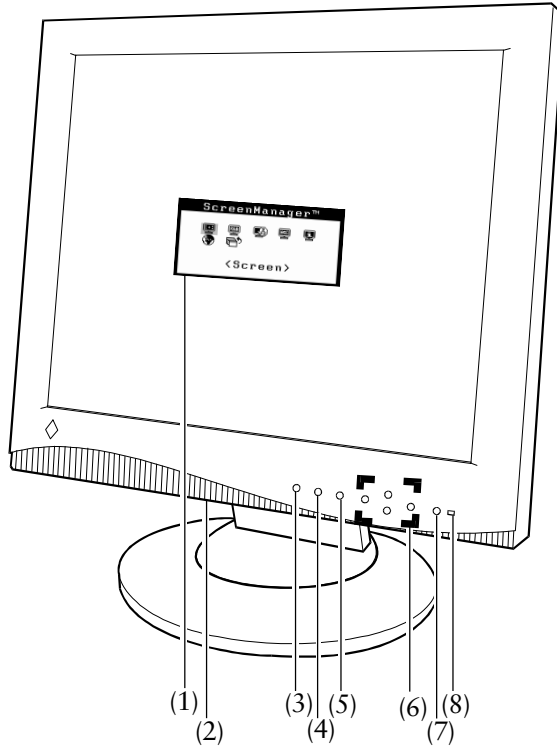

- (1) ScreenManager™
- (2) Power Terminal Covers for the Optional peripheral
- (3) Input Signal Selection Button
- (4) Auto Adjustment Button
- (5) Enter Button
- (6) Control Buttons
- (7) Power Button
- (8) Power Indicator*¹

Indicated color	Power-on status
Green	Power is on
Yellow	Power save mode
Flashing yellow (2 times for each)	Power save mode Digital only
Slowly flashing Yellow	Power is off (Main power is on)

*¹ Regarding the power indicator for the “Off Timer”, see page 20.

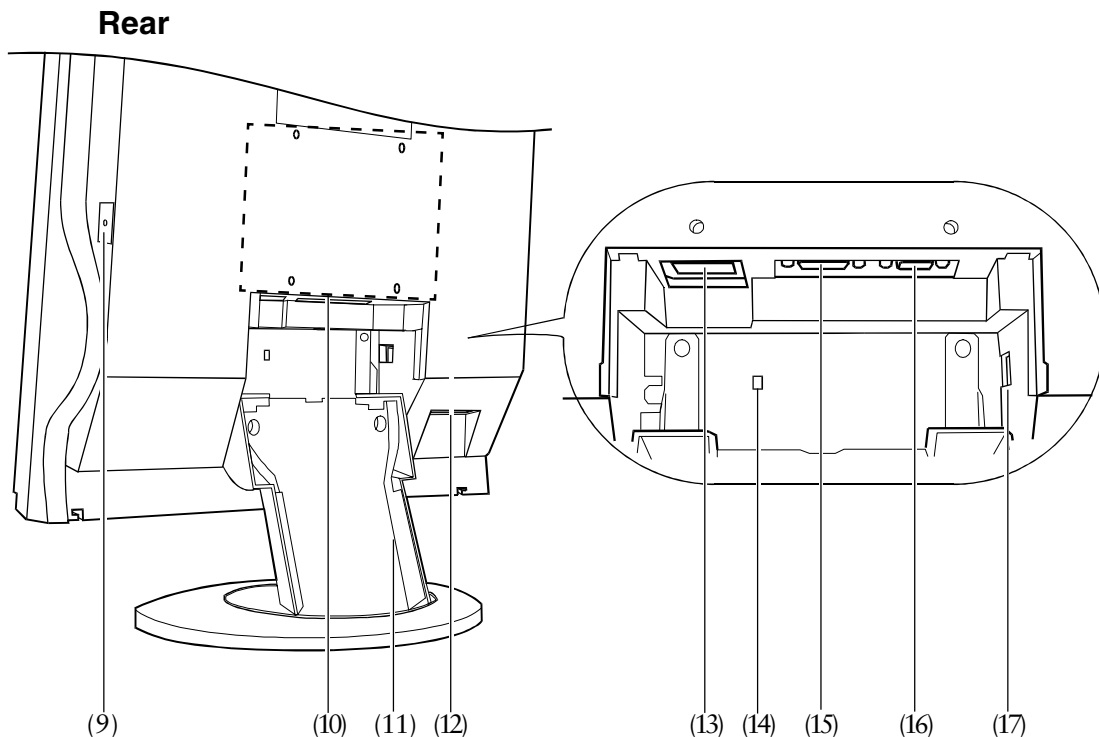

- (9) Main Power Switch
- (10) 4 Holes for Mounting an Arm-Stand^{*2}
- (11) Stand (Detachable)^{*2}
- (12) USB Downstream Ports for L371 x 2/L671 x 4
- (13) Power Connector
- (14) Security Lock Slot^{*3}
- (15) DVI-I Input Connector
- (16) D-Sub mini 15 pin Input Connector
- (17) USB Upstream Port for L371/L671 x 1

^{*2} The LCD monitor can be used with an optional arm stand by removing the stand (see page 36).

^{*3} Allows for connection of a security cable. This lock supports Kensington's MicroSaver security system. For further information, please consult:

Kensington Technology Group 2855 Campus Drive, San Mateo, CA 94403 USA
800-650-4242, x3348

Intl: 650-572-2700, x3348 / Fax: 650-572-9675

<http://www.kensington.com>

2. CABLE CONNECTION

When connecting the DVI-I cable for digital input, please purchase the FD-C04 optional cable. See the section 2-3, “Digital input connection” for details.

2-1. Before connecting

Before connecting your monitor to the PC, change the display screen settings (resolution ^{p.47)}and frequency) in accordance with the charts below.

* supported

Resolution	Frequency	Remarks	L371	L671
640 x 480	~ 85 Hz	VGA, VESA	*	*
720 x 400	70 Hz	VGA Text	*	*
800 x 600	~ 85 Hz	VESA	*	*
832 x 624	75 Hz	Apple Macintosh	*	*
1024 x 768	~ 75 Hz	VESA	*	
1024 x 768	~ 85 Hz	VESA		*
1152 x 870	75 Hz	Apple Macintosh		*
1152 x 900	76 Hz	SUN WS		*
1280 x 960	~ 85 Hz	Apple Macintosh		*
1280 x 1024	~ 75 Hz	VESA		*

NOTE

- About Plug & Play of the monitor
When your computer and display support VESA DDC, the suitable resolution and the refresh rate are set by just plugging your display into the computer without any manual settings.
When your computer system supports Plug & Play, the Display Information File is not required except for installing the Color Profile.

2-2. Connecting the signal cable

NOTE

- Be sure that the power switches of both the PC and the monitor are OFF.

1. Remove the rear cover from the monitor.

When removing the rear cover, push down the buttons while pulling.

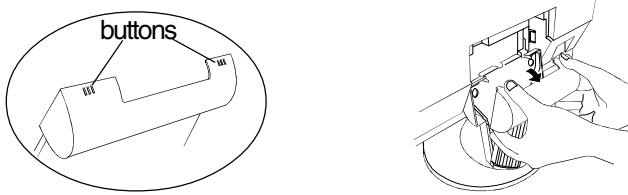

2. Plug the signal cable into the D-Sub connector at the rear of the monitor and the other end of the cable into the video connector on the PC.

After connecting, secure the connection with the screw-in fasteners.

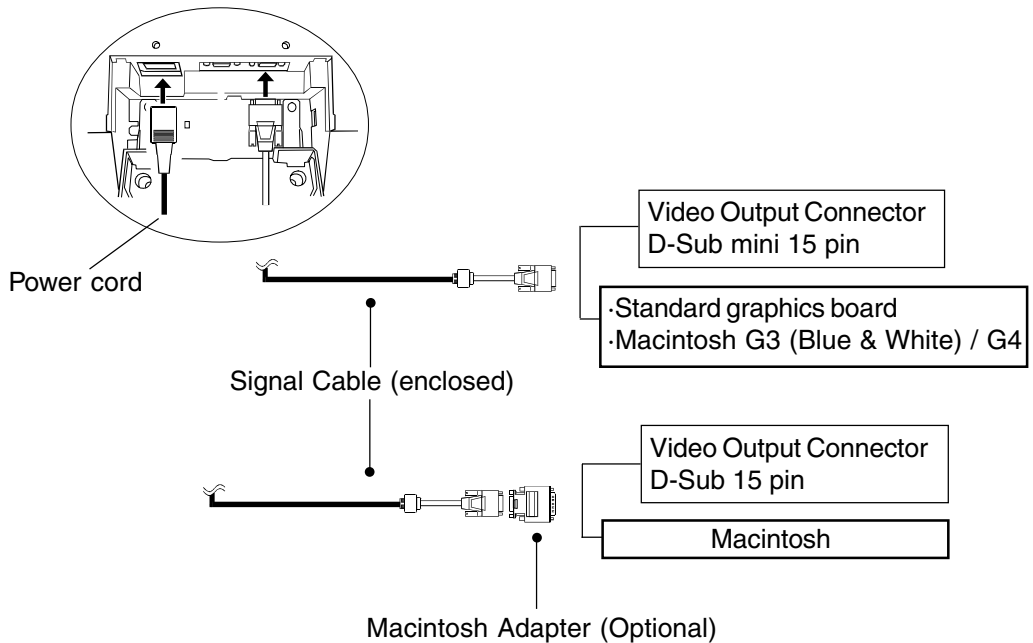

3. Plug the power cord into the power connector on the rear of the monitor.

 WARNING

- **Use the enclosed power cord. If using the power cord other than the enclosed one, follow these guidelines.**

[USA and Canada]

Use a UL LISTED/CSA LABELED or CERTIFIED power cord set meeting the following specifications:

- * Rating: min. 125 V, 10 A
- * Length: max.2.0 m
- * Type: SVT
- * Plug type: NEMA 5-15P, Parallel blade, Grounding type, 125 V, 10 A

[Europe]

Use a proper European standard approved power cord meeting the following specifications:

- * Rating: min. 250 V, 10 A
- * Length: max.2.0 m
- * Type: H05VV-F 3G 1 mm²

Use a plug type approved by the country where you reside.

Failure to do so may cause fire or electric shock.

4. Replacing the connector cover and the rear cover.

- 1) Insert the rear cover into the inlets at the bottom of the stand.
- 2) For smooth attachment, the monitor should be tilted forward. Attach the connector cover to the rear panel of the monitor.

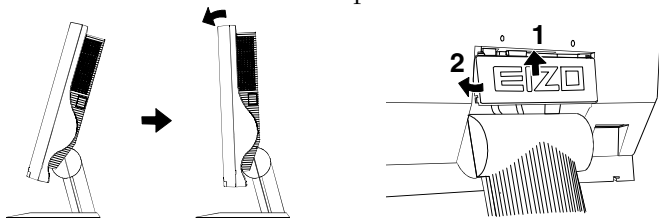

5. Plug the other end of the power cord into a power outlet.

 WARNING

- **The equipment must be connected to a grounded main outlet.**



6. Turn on the monitor's main power and then switch on the PC's power.

Whenever finished, turn off the PC and the monitor.

2-3. Digital input connection

1. Change the display screen settings (resolution and frequency) in accordance with the charts below.

Only the following resolutions with frequency can be displayed on this model.

* supported

Resolution	Frequency	Remarks	L371	L671
640 x 480	60 Hz	VGA	*	*
720 x 400	70 Hz	VGA Text	*	*
800 x 600	60 Hz	VESA	*	*
1024 x 768	60 Hz	VESA	*	*
1152 x 864	60 Hz	VESA		*
1280 x 960	60 Hz	VESA		*
1280 x 1024	60 Hz	VESA		*

2. To connect the DVI-I cable, refer to section 2-2, “Connecting the signal cable”.

The FD-C04 is an optional cable.

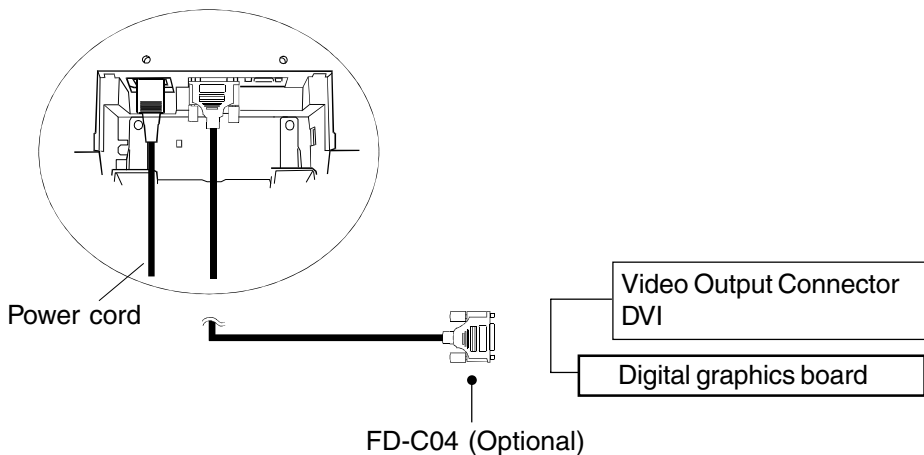

NOTE

- If the position of the screen is incorrect or the screen chipped, see section 5, “ADJUSTMENT FOR DIGITAL” and proceed with the screen adjustment.

3. ScreenManager

3-1. How to use the ScreenManager

As shown on the display, the ScreenManager is used to adjust the LCD monitor. ScreenManager consists of main menus and sub menus. Adjustments are made using the Enter and Control buttons (up, down, right and left) located on the front panel.

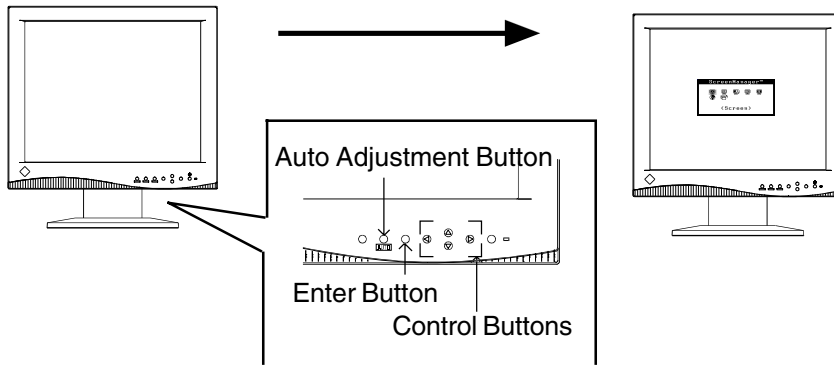

1. Entering the ScreenManager

Push the Enter button once to display the main menu of the ScreenManager.

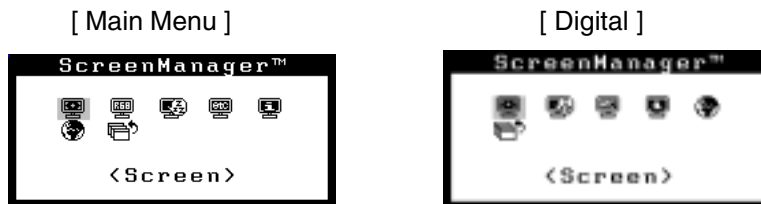

2. Making Adjustments and Settings

- (1) Select the desired sub menu icon using the Control buttons and push the Enter button. The sub menu appears.
- (2) Use the Control buttons to select the desired setting icon and push the Enter button. The setting menu appears.
- (3) Use the Control buttons to make all required adjustments and push the Enter button to save the settings.

3. Exiting the ScreenManager

- (1) To return to the main menu, select the "Return" icon or push the down button twice, followed by the Enter button.
- (2) To exit the ScreenManager, select "Exit" icon and push the Enter button.

NOTE

- Double clicking the Enter button at any time also exits the ScreenManager menu.
- Leaving the ScreenManager idle for 45 seconds or more will turn the adjustment off automatically, without saving the adjustments.

3-2. ScreenManager Adjustments and Settings.

The following table shows all the ScreenManager’s adjustment and setting menus. D is for Digital input.

Main menu	Sub menu		D	Reference
Screen	Contrast	✓		4. ADJUSTMENT(p.21) 5. ADJUSTMENT for digital input (p.29)
	Brightness	✓	✓	
	Clock	✓		
	Phase	✓		
	Position	✓	✓	
	Resolution	✓	✓	
	Smoothing	✓	✓	
Color	Color mode	✓		
	Gain	✓		
	Save	✓		
	Reset	✓		
PowerManager	DVI DMPM		✓	
	VESA DPMS	✓		
	EIZO MPMS	✓		
OthersScreen	Size	✓	✓	
	Border Intensity	✓	✓	
	Off Timer	✓	✓	Set the monitor’s off timer to on or off. (p.20)
	Input Priority	✓	✓	Select the priority input signal. (p.35)
	Beep	✓	✓	Set the Monitor’s beeper to on or off. (p.45)
	Menu Position	✓	✓	Adjust the ScreenManager’s menu position.
	Reset	✓	✓	Return to the factory default settings except color gain settings. (p.45)
Information	Information	✓	✓	Review the current ScreenManager’s settings.
Language	English, German, French Spanish, Italian, Swedish and Japanese	✓	✓	Select the ScreenManager’s language.

3-3. Useful Functions

Adjustment Lock

Use the “Adjustment Lock” function to prevent any accidental changes.

Locked function	• Auto adjustment button adjustments and settings in the ScreenManager.
Unlocked function	• Adjustment of contrast and brightness by the control buttons. • Input signal selection button

- To lock
Press on the Auto adjustment button while switching on the monitor’s power.
- To unlock
Switch off the monitor’s power, then hold down the Auto adjustment button once again and turn the power back on.

Off Timer

The off timer function causes the monitor to automatically enter a power off state after a predetermined amount of time has lapsed. This function was created to reduce afterimage ^{P.46)} characteristics that are particular to LCD monitors when the monitor screen is left on for a long period without use.

[Procedure]

- (1) Select “Off Timer” in the ScreenManager “Others” menu.
- (2) Select “Enable” and press the right and left buttons to adjust the “On Period” (1 to 23 hours).

[Off timer system]

PC	Monitor	LED
On Period (1H~23H)	Operation	Green
Last 15 min. in "On period"	Advance Notice ^{*1}	Green Flashing
"On period" expired	"Power Off" Mode	Flashing yellow slowly

^{*1}Advance notice (LED flashing green) will be given 15 minutes before the monitor automatically enters the “Power Off” mode. To delay entering the “Power Off” mode, press the power button during the advance notice period. The monitor will continue to operate for an additional 90 minutes.

Press the power button to return to a normal screen.

NOTE

- The off timer function works while the PowerManager is active, but there is no advance notice before the monitor’s power is switched off.

4. ADJUSTMENT

When connecting the DVI-I cable for digital input, please see section 5, “ADJUSTMENT FOR DIGITAL”.

4-1. Screen Adjustment

Screen adjustments for the LCD monitor should be used in suppressing screen flickering and also for adjusting the screen to its proper position. There is only one correct position for each display mode. It is also recommended to use the ScreenManager function when first installing the display or whenever changing the system. For convenience, an easy set-up Program installed on the utility disk to assist in the set-up procedure is provided.

Adjustment Procedure

NOTE

- Allow the LCD monitor to stabilize for at least 20 minutes before making image adjustments.

1. Push the Auto adjustment button on the front panel.

The message “Your setting will be lost, if you press again now.” appears and remains on the screen for 5 seconds. While the message is on the screen, push the Auto adjustment button again to automatically adjust the clock, phase, screen position and resolution. If you do not wish to do adjust the screen, do not push the Auto adjustment button again.

If the appropriate screen can not be made by using the Auto adjustment button, adjust the screen through the following procedures.

2. Install the “Screen adjustment program”.

Having read the “readme.txt” file, install and run the “Screen adjustment program” in the enclosed EIZO LCD utility disk.

Step by step adjustment is provided by the wizard guide.

NOTE

- If the user’s operating system has no utility disk (e.g. OS/2), we recommend setting the desktop pattern to that as shown in the diagram below.

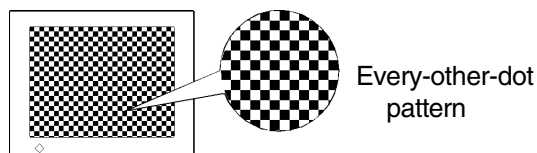

3. Adjust by using “Screen” menu in the ScreenManager.

(1) Vertical bars appear on the screen

→  Use the “Clock” ^{p.46)} adjustment

Select the “Clock” and eliminate the vertical bars by using the right and left of the control buttons. Do not continuously press the control buttons, as the adjustment value will change quickly and make it difficult to locate the most suitable adjustment point.

If the horizontal flickering, blur or bars appear, proceed to “Phase” adjustment as follows.



NOTE

- When adjusting the “Clock,” the horizontal screen size will also change.

(2) Horizontal flickering, blurring or bars appear on the screen.

→  Use the “Phase” ^{p.47)} adjustment

Select the “Phase” and eliminate the horizontal flickering, blurring or bars by using the right and left buttons.

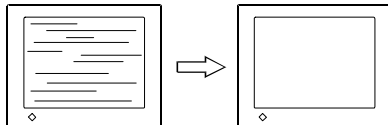

NOTE

- Horizontal bars may not completely disappear from the screen depending on the PC.

(3) The screen position is incorrect.

→  “Position” adjustment

The correct displayed position of LCD monitor is decided because the number and the position of the pixels are fixed. The “Position” adjustment moves the image to the correct position.

Select “Position” and adjust the position of the upper left corner of the image by using the up, down, right and left buttons in order to align the screen.

If vertical bars of distortion appear after finishing the “Position” adjustment, return to “Clock” adjustment and repeat the previously explained adjustment procedure (“Clock” → “Phase” → “Position”).

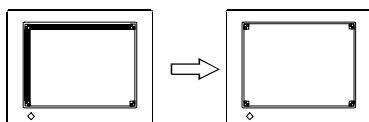

(4) Screen image is smaller or larger than the actual screen images.

→  “Resolution” adjustment

Adjustment is needed when the input signal resolution and the resolution now being displayed is different.

Select “Resolution” and confirm if the resolution now being displayed is the same as the input resolution. If it is not, adjust the vertical resolution using the up and down button and adjust the horizontal resolution using the right and left buttons.

Smaller than the actual screen images.

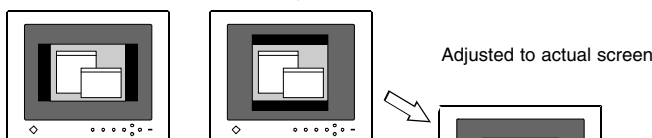

Larger than the actual screen images.

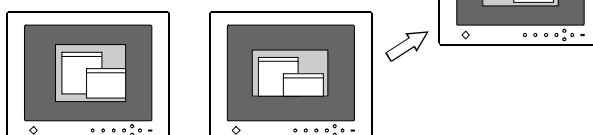

4. Set the Contrast of the screen.

→  Adjust the “Contrast”

This controls the contrast of the screen. The contrast is changed by adjusting the gain level of the input signal to obtain the maximum contrast.

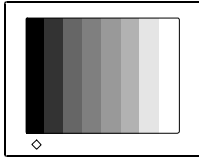

OK

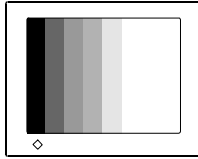

Too High

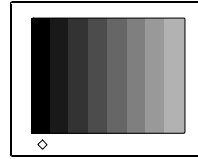

Too Low

Select the “Contrast/Brightness” in the screen menu..

[Auto]

Push the Auto adjustment button on the front panel while displaying the “Contrast/Brightness” menu to automatically adjust the contrast. The screen blanks for a moment, and adjusts the contrast to the maximum contrast level of the current input signal.

[Manual]

Adjust the contrast level by using the right and left buttons until the percentage color is on the border of white and yellow or fully yellow. (In the case of the percentage color switching from white to yellow, please note that this is not an error but actually the most optimum adjustment point.)

5. Set the Brightness of the Screen.

→  Adjust the “Brightness”

This controls the brightness of the screen. The brightness of the entire screen is controlled by changing the brightness of the backlight.

Select “Contrast/Brightness” in the screen menu and adjust by using the up and down buttons.

NOTE

- Directly pressing the control buttons also adjusts the contrast and brightness. Press the “Enter” button to save and exit the settings after the adjustment.

4-2. Displaying a low resolutions

1. Set the brightness of the black area surrounding the displayed image.

→  Set the “Border Intensity”

Select “Border Intensity” in the others menu and adjust by using the right and left buttons.

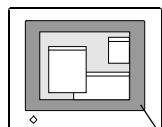

Border

2. Enlarge the screen size when displaying a low resolution.

→  Select “Screen Size”

Select the “Screen Size” in the others menu and select the screen size by using the up and down buttons.

• Full	Displays the picture on the screen in full, irrespective of the picture’s resolution. Since the vertical resolution and the horizontal resolution are enlarged at different rates, some images may appear distorted.
• Enlarged	Displays the picture on the screen in full, considering the width of the screen. Since the pixel elements are fixed, some lines of the characters or pictures may be displayed with a different width.
• Normal	Displays the picture at the actual Screen resolution.

[Example: L671]

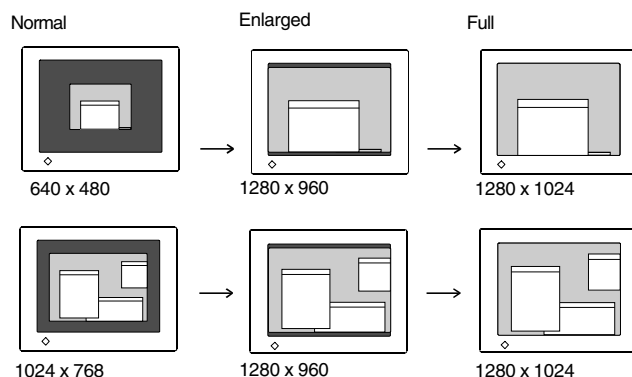

3. Smooth the blurred texts of the enlarged screen.

→  Adjust the “Smoothing”

Select the suitable level from 1~5 (soft ~ sharp).

Select “Smoothing” in the screen menu and adjust by using the right and left buttons.

4-3. Color Adjustment

1. To change the adjust the white color.

→  Select the desired color from “Color Mode”

When using white background applications, you can change the white color tone. Select from option 1,2 or 3 on the “Color Mode” in the ScreenManager “Color” menu.

Mode 1 (default)	The normal white color of the LCD panel itself which has the maximum contrast level.
Mode 2	The white color tone is slightly bluish. The contrast level is reduced in Mode 2.
Mode 3	The white color tone is slightly reddish. The contrast level is reduced in Mode 3.

2. To adjust each (red, blue and green) color tone.

→  Adjust the “Gain”^{p.46)}

By adjusting the red, green and blue color tones for each mode, custom colors can be defined.

[Procedure]

- 1) Display a white or gray background image.
- 2) Adjust each color (The values shown in percentages are available only as a reference tool.) until you can create a uniform white screen. The adjustment works effectively only when the percentages appear black. (Magenta percentage indicates the color’s saturation.)
- 3) To register the adjustment, select the “Save” icon and then push the Enter button. If the settings are not saved, all adjustments will be lost.
- 4) Finally, readjust the contrast in the “Screen” menu to get the best image clarity.

NOTE

- Allow the LCD monitor to stabilize for at least 20 minutes before making image adjustments.
- You can recall the default color gain setting for the current color mode (1, 2, 3) by using the “Reset”.
- The values shown in percentages represent the current level within the specific adjustment only. They are available only as a reference tool. (To create a uniform white or black screen, the percentages for each will probably not be the same.)

4-4. Power-save Setup

This monitor complies with the VESA DPMS ^{p.47)} standard and adopts a power saving method, EIZO MPMS ^{p.46)}, which works with a blank screen (totally black screen) like “Blank Screen” ScreenSaver software.

1. To use the PC’s power saving system (VESA DPMS).

[Procedure]

- (1) Set the PC’s power saving settings.
- (2) Select “VESA DPMS” in the “PowerManager” menu.

[Power saving system]

PC		Monitor	LED	Power consumption
On		Operation	Green	L371: 30 W L671: 50 W
Power saving mode	STAND-BY SUSPEND OFF	Power saving	Yellow	Less than 5 W

Operate the mouse or keyboard to return to a normal screen.

2. To set the power save with ScreenSaver (EIZO MPMS) software.

[Procedure]

- (1) Set the PC’s appropriate ScreenSaver settings or blank the screen (totally black screen).
- (2) Select “EIZO MPMS” from the “PowerManager” menu.

[Power saving system]

PC		Monitor	LED	Power consumption
ON		Operation	Green	L371: 30 W L671: 50 W
Blank the screen (ScreenSaver or Macintosh Energy Saver)		Power saving	Yellow	Less than 5 W

Operate the mouse or keyboard to return to a normal screen.

NOTE

- EIZO MPMS should be used with Macintosh “EnergySaver”.
- Do your part to conserve energy, turn off the monitor when you are finished using it. Disconnecting the monitor from the power supply is recommended to save energy completely.
- Even if the monitor is in a power saving mode, USB compliant devices function when they are connected to the monitor’s USB (both the upstream and the downstream ports). Therefore, power consumption of the monitor will change according to the connected devices even if the monitor is in a power saving mode.

5. ADJUSTMENT FOR DIGITAL

5-1. Screen Adjustment

The monitor displays the digital input image correctly based on its pre-setting data. However, if the image position is not incorrect or larger than the actual image screen, please adjust the following adjustment items using the “Screen” menu of the ScreenManager.

NOTE

- Allow the monitor to warm up for at least 20 minutes before making adjustments.

1. The screen position is not incorrect.

→  “Position” adjustment

The correct displayed position of the monitor is decided because the number and the position of the pixels are fixed. The “Position” adjustment moves the image to the correct position.

Select “Position” and adjust the position of the upper left corner of the image by using the up, down, right and left buttons in order to align the screen.

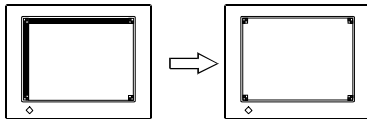

2. Screen image is smaller or larger than the actual screen images.

→  “Resolution” adjustment

Adjustment is needed when the input signal resolution and the resolution now being displayed are different.

Select “Resolution” and confirm if the resolution now being displayed is the same as the input resolution. If it is not, adjust the vertical resolution using the up and down button and adjust the horizontal resolution using the right and left buttons.

Smaller than the actual screen images.

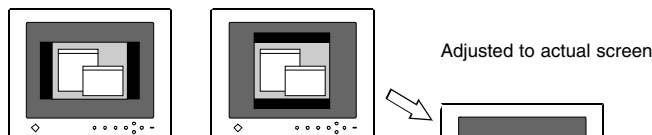

Larger than the actual screen images.

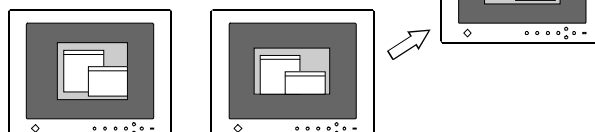

3. Set the Brightness of the screen.

→  Adjust the “Brightness”

This controls the brightness of the screen. The brightness of the entire screen is controlled by changing the brightness of the backlight.

Select the “Brightness” in the screen menu and adjust by using the up and down buttons.

5-2. Displaying the low resolutions

Please see section 4-2, “Displaying the low resolutions”.

5-3. Power-save Setup

This monitor complies with the DVI DMPM ^{p.46}.

[Procedure]

- (1) Set the PC's power saving settings.
- (2) Select "DVI DMPM" in the "PowerManager" menu.

[Power saving system]

PC	Monitor	LED	Power consumption
On	Operation	Green	L371: 30 W L671: 50 W
Power saving	Power saving	Yellow	Less than 5 W
Off mode	Power saving ^{*1}	Flashing yellow (2 times for each)	Less than 3 W

^{*1} Power saving through the PC's off mode is only supported when "Manual" is selected on the ScreenManager's "Input Priority".

Operate the mouse or keyboard to return to a normal screen from the Power save mode of the PC.

Power on the PC to return a normal screen from the Off mode of the PC.

NOTE

- Do your part to conserve energy, turn off the monitor when you are finished using it. Disconnecting the monitor from the power supply is recommended to save energy completely.
- Even if the monitor is in a power saving mode, USB compliant devices function when they are connected to the monitor's USB (both the upstream and the downstream ports). Therefore, power consumption of the monitor will change according to the connected devices, even if the monitor is in a power saving mode.

6. MAKING USE OF USB (Universal Serial Bus)

This monitor provides a hub which supports the USB standard. When connecting to a USB compliant PC or another hub, the monitor functions as a hub to which the USB compliant peripherals can be easily connected.

Required system environment

- PC equipped with USB ports or another USB hub connected to the USB compliant PC
 - Windows 98/2000 // Mac OS 8.5.1 or later
 - USB cable / MD-C93 (Optional)
-
- The USB hub function may not work properly depending on the PC, OS or peripherals. Please consult the manufacturer of each device about the USB support.
 - When the monitor is not on, the peripherals connected to the downstream ports will not operate.
 - Even if the monitor is in a power saving mode, the devices connected to the monitor's USB ports (both the upstream and the downstream) will function.

Connecting to the USB HUB

- Do not connect the downstream port of the monitor to any peripherals until finishing the USB function.
- The followings are procedures for the Windows 98 Second Edition/2000 and Mac OS.

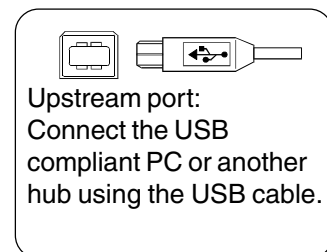
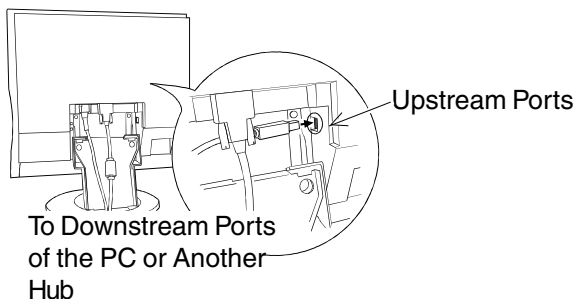

- 1.** Connect the monitor to the PC with the signal cable (See page 15) first, then turn on the PC.
- 2.** Connect the upstream port of the monitor to the downstream port of the USB compliant PC or another hub by using the USB cable .



After connecting the USB cable, the USB function can be set up automatically.

- After setting up, the monitor's USB hub is available for connecting USB compliant peripherals to the downstream ports of the monitor.

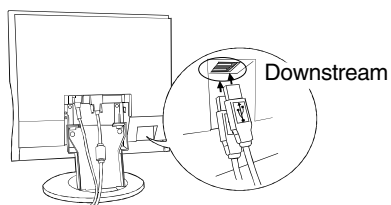
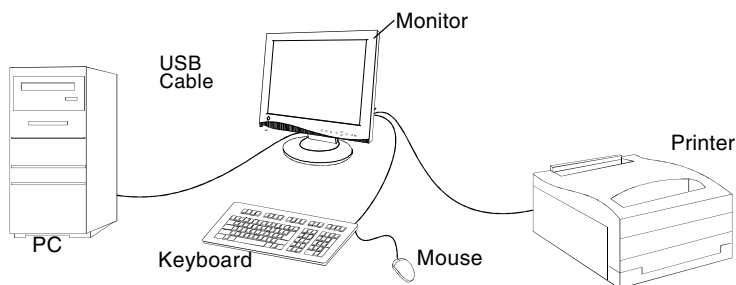

(Example of connection: L371)

Downstream connector

Downstream ports:
Connect the cables from USB compliant peripherals such as a mouse, keyboard, etc.

(Example of connection: L671)

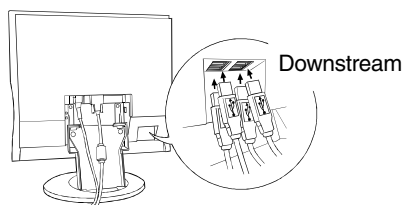
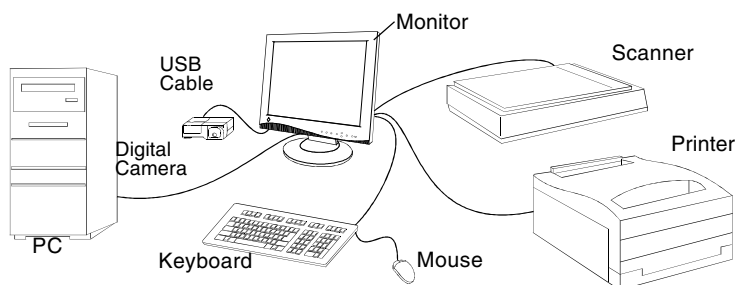
Downstream connector

Downstream ports:
Connect the cables from USB compliant peripherals such as a mouse, keyboard, etc.

7. CONNECTING TWO PCs to THE MONITOR

Two PCs can be connected to the monitor through the Signal 1 and the Signal 2 on the back of the monitor.

- **Connecting case [DVI-I (signal 1) x D-Sub mini 15 pin (signal 2)]**

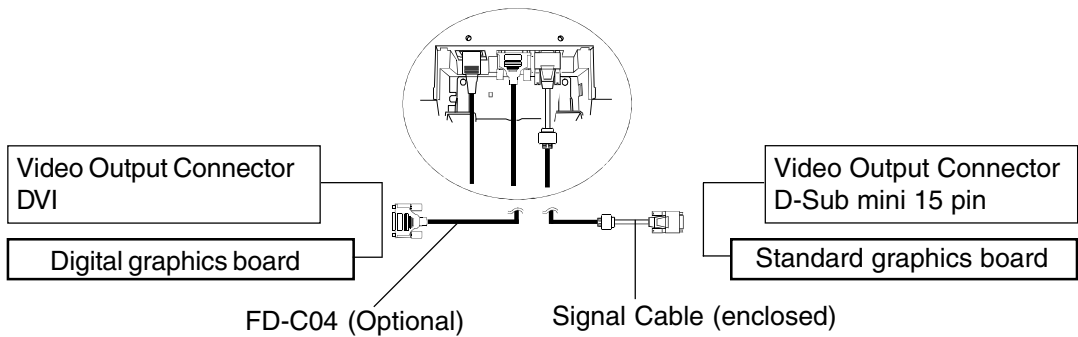

- **Connecting case [D-Sub mini 15 pin (signal 1) x D-Sub mini 15 pin (signal 2)]**

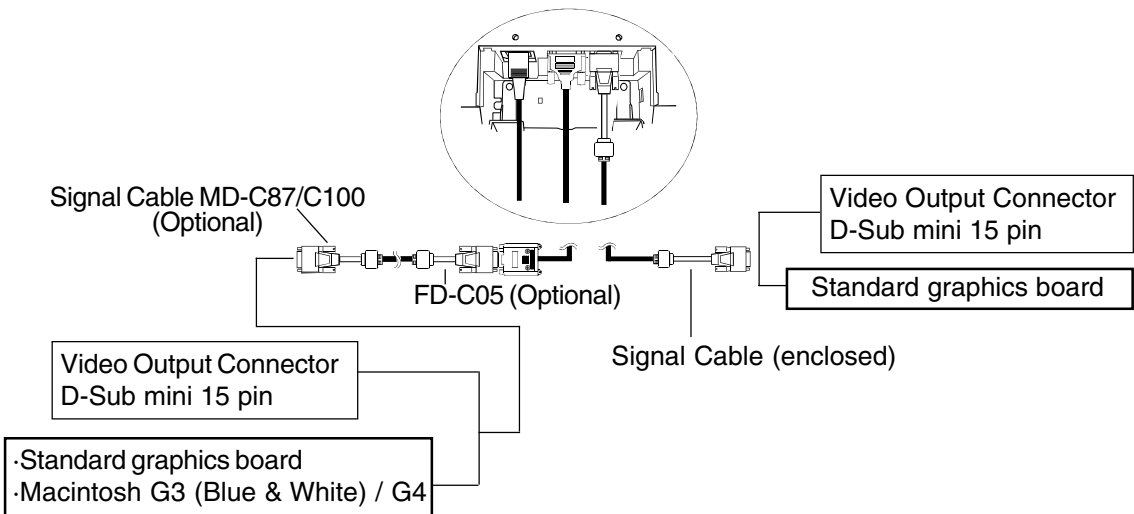

The DVI-I input connector can be used also as a D-Sub 15 pin input connector with optional cable FD-C05

Selecting the active input

The Input signal selection button on the front panel can be used to select either Signal 1 or Signal 2 as the active input at any time. Every time the button is pressed, the input changes.

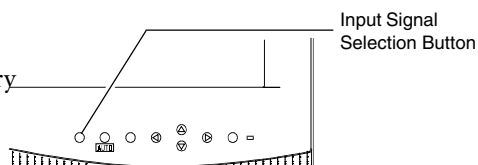

The priority input signal

This function is used to select which PC will have priority to control the monitor when utilizing two PCs. The monitor constantly checks the input signals and switches automatically in accordance with the “Input Priority” setting (see table below).

Once a priority is set, whenever a change of signal is detected at the selected input, the monitor will switch the input to that signal.

In the case of only one signal being present at either input, the monitor automatically detects and displays that signal.

Priority setting	Performance
Signal 1	If signals from both inputs are present, the monitor gives preference to Signal 1 in the following cases. <ul style="list-style-type: none"> • When the power of the monitor is turned ON • When the signal input to Signal 1 is changed even if active input was Signal 2.
Signal 2	If signals from both inputs are present, the monitor gives preference to Signal 2 in the following cases. <ul style="list-style-type: none"> • When the power of the monitor is turned ON • When the signal input to Signal 2 is changed even if active input was Signal 1.
Manual	The monitor will not detect signals automatically in this mode. Select the active input by pressing the input signal selection button on the monitor's front panel.

NOTE

- Regarding the power saving mode
When the Signal 1 or Signal 2 is selected, the power saving mode of the monitor activates only if both PCs are in power saving mode.

8. ATTACHING AN ARM STAND

The LCD monitor can be used with an arm stand by removing the tilt stand and attaching the arm stand to the LCD monitor.

NOTE

- Use an arm stand that satisfies the followings.
 - When using the LCD monitor with an arm stand, the arm stand must be VESA approved :

[L371]

- Use an arm stand with a 75 mm x 75 mm hole spacing on the arm mounting pad.
- Use an arm stand that is able to support an object weighing 8.0 kg.

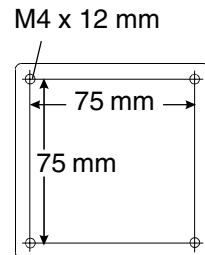

[L671]

- Use an arm stand with a 100 mm x 100 mm hole spacing on the arm mounting pad.
- Use an arm stand that is able to support an object weighing 13.5 kg.

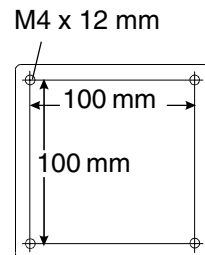

- TÜV/GS approved arm stand.
 - Use an arm stand with sufficient stability (mechanical firmness) to support the weight of the monitor.
 - Use an arm stand remaining that position where it is manually moved.
 - Use an arm stand with the ability to tilt the monitor forward and backward.
 - Use an arm stand less than or equal to 500 mm in relation to the desk surface when the arm stand is in its lowest position.
- Please connect cables after attaching an arm stand.

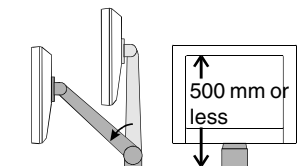

(Example)

Setup Procedure

1. Lay the LCD monitor down as shown below. Do not scratch the panel.

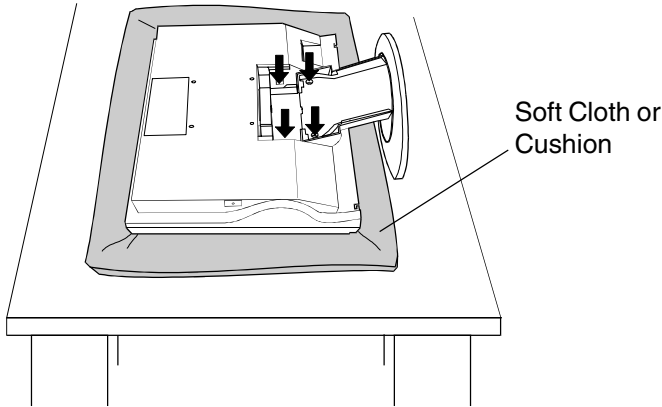

2. Remove the stand by loosening the screws.(4 pcs of 4 x 10 S-Type Ni/Fe)
3. Attach an arm stand to the LCD monitor securely.

WARNING

Install the monitor securely when attaching to an arm stand.

When attaching an arm stand, please refer to the user's manual of the arm stand and install the monitor securely with the enclosed screws. Not doing so may cause the monitor to come unattached, which may result in injury or equipment damage. When the monitor is dropped, please ask your dealer for advice. Do not continue using a damaged monitor. Using a damaged monitor may result in fire or electric shock.

When reattaching the tilt stand, please use the same screws (4 x 10 S-Type Ni/Fe) and tighten them securely.

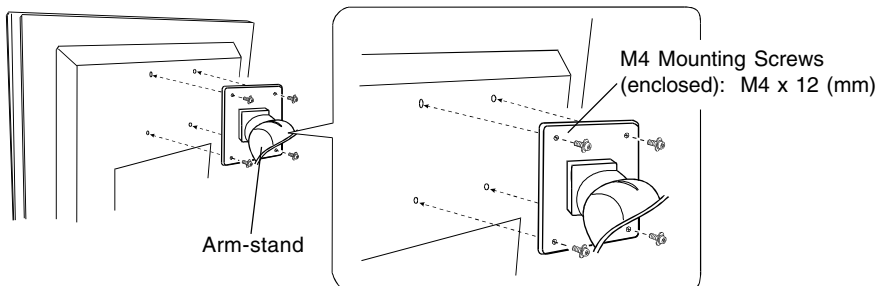





9. TROUBLESHOOTING

If a problem persists even after applying the suggested remedies, contact an EIZO dealer.

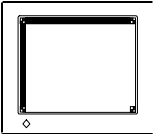
- No picture problems → See No.1 ~ No.2
- Imaging problems → See No.3 ~ No.12
- USB problems → See No.18 ~ No.19
- Other problems → See No.13 ~ No.17

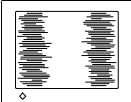
Problems	Points to check with possible solutions
<p>1. No picture</p> <ul style="list-style-type: none"> • Indicator status: Off 	<ul style="list-style-type: none"> <input type="checkbox"/> Check that the power cord is correctly connected. <input type="checkbox"/> If the problem persists, turn off the monitor power for a few minutes, then turn it back on and try again.
<ul style="list-style-type: none"> • Indicator status: Green • Indicator status: Yellow • Indicator status: Slowly flashing Yellow 	<ul style="list-style-type: none"> <input type="checkbox"/> Check the “Contrast and Brightness” settings. Minimum settings will cause screen to be blank. <input type="checkbox"/> Try pressing a key on the keyboard, or clicking the mouse. (p.28) <input type="checkbox"/> Try pressing the power button.
<p>2. Following messages appear.</p> <div style="border: 2px solid black; padding: 5px; margin: 10px 0;"> <p style="text-align: center; font-weight: bold; font-size: small;">Signal Check</p> <p style="text-align: center;">Signal 2</p> <p>fH: 0.0kHz fV: 0.0Hz</p> </div>	<p>These messages appear when the signal is not inputted correctly, even if the monitor functions properly. Error messages shown below will remain on the screen for 40 seconds.</p> <ul style="list-style-type: none"> <input type="checkbox"/> When the image is displayed correctly after a short time, there is no problem with the monitor. (Some PCs do not output the signal soon after powering on.) <input type="checkbox"/> Check that the PC is turned ON. <input type="checkbox"/> Check that the signal cable is properly connected to the PC or graphics board. <input type="checkbox"/> Switch the signal input by pressing the input signal selection button on the front control panel.
<ul style="list-style-type: none"> • Whenever an error signal message appears, the signal frequency will be displayed in red. (Example) <div style="border: 2px solid black; padding: 5px; margin: 10px 0;"> <p style="text-align: center; font-weight: bold; font-size: small;">Signal Error</p> <p style="text-align: center;">Signal 2</p> <p>fH: 93.7kHz fV: 75.0Hz</p> </div>	<ul style="list-style-type: none"> <input type="checkbox"/> Use the graphics board’s utility software to change the frequency setting. (Refer to the manual of the graphics board.)

Problems	Points to check with possible solutions
<p>3. Display position is incorrect.</p> 	<ul style="list-style-type: none"> <input type="checkbox"/> Adjust the image position using the “Position”. (p.23) <input type="checkbox"/> If the problem persists, use the graphics board’s utility software to change the display position if available.
<p>4. Screen image is smaller or larger than the actual screen images.</p>	<ul style="list-style-type: none"> <input type="checkbox"/> Adjust the resolution using the “Resolution”. (p.23)
<p>5. Vertical bars of distortion appear.</p> 	<ul style="list-style-type: none"> <input type="checkbox"/> Decrease the vertical bars using the “Clock”. (p.22)
<p>6. Horizontal bars of distortion appear.</p> 	<ul style="list-style-type: none"> <input type="checkbox"/> Decrease the horizontal bars using the “Phase”. (p.22)
<p>7. Letters and lines appear blurred.</p>	<ul style="list-style-type: none"> <input type="checkbox"/> Adjust the blurred lines using “Smoothing”. (p.26)
<p>8. Distortion appears like the figure below.</p> 	<ul style="list-style-type: none"> <input type="checkbox"/> This happens when both composite (X-OR) input signal and separate vertical synchronizing signal are input. Please select one of the two.
<p>9. The screen is too bright or too dark.</p>	<ul style="list-style-type: none"> <input type="checkbox"/> Adjust the “contrast and brightness”. (The backlight of the LCD monitor has a fixed life span. When the screen becomes dark or begins to flicker, please contact your dealer.)
<p>10. Afterimages appear.</p>	<ul style="list-style-type: none"> <input type="checkbox"/> When the screen image is changed after displaying the same image for a long period, an afterimage may appear. Use the “Off Timer” function and avoid keeping the screen on all the time. (p.20)

Problems	Points to check with possible solutions
11. The screen has defective pixels (e.g. slightly light or dark).	<input type="checkbox"/> This is due to the characteristics of the panel itself, and not the LCD product.
12. Fingerprints remain on the screen.	<input type="checkbox"/> Leaving the screen white may solve the problem.
13. The “Smoothing” can not be selected.	<input type="checkbox"/> “Smoothing” is disabled when the screen is displayed in the following resolutions. <ul style="list-style-type: none"> • L671: - 1280 x 1024, 1280 x 960. • L371: - 1024 x 768. <input type="checkbox"/> The image size is doubled both in horizontally and vertically to (i.e. 1280 x 960 enlarged from 640 x 480) provide clear focus which does not require this function.
14. The utility disk is unable to be opened (for Macintosh only).	<input type="checkbox"/> Some PCs without PC-Exchange do not allow the utility disk to be opened. Please set the desktop pattern to every-other-dot before adjustment. (p.21)
15. • The Enter button does not operate. • The Auto adjustment button does not operate.	<input type="checkbox"/> The adjustment lock is probably on. To unlock: switch the LCD monitor off. Then, while pressing the Auto adjustment button switch, the power on. (p.20)
16. The Auto adjustment button does not work properly.	<input type="checkbox"/> The Auto sizing function is intended for use on the Macintosh and on AT-compatible PC running Windows. It may not work properly in either of the following cases. When running an AT-compatible PC on MS-DOS (Not windows). The background color for the “wall paper” or “desktop” pattern is set to black. Some signals from a graphics board may not function properly.

Problems	Points to check with possible solutions
<p>17. Frequency does not change after installing “Monitor information file” in the attached utility disk on Windows 95/98/2000.</p>	<p><input type="checkbox"/> Use the graphics board’s utility software to change the input signal frequency.</p>
<p>18. USB function cannot be setup.</p>	<p><input type="checkbox"/> Check that the USB cable is correctly connected. <input type="checkbox"/> Check that the PC and OS are USB compliant. (For verification of USB support, consult the manufacturer of each system.) <input type="checkbox"/> Check the PC’s BIOS setting for USB. (For details, refer to the manual of the PC.)</p>
<p>19. PC is hung up. / The peripherals connected to the downstream ports do not operate.</p>	<p><input type="checkbox"/> Check that the USB cable is correctly connected. <input type="checkbox"/> Check the downstream ports by connecting the peripherals to other downstream ports. If the problem is solved by doing this, contact an EIZO dealer. <input type="checkbox"/> Try executing the following method. - Restarting the PC - Connecting the PC and peripherals directly If the problem is solved by doing this, contact an EIZO dealer. <input type="checkbox"/> The power button of the APPLE keyboard does not operate if it is connected to the EIZO USB Hub. Please connect the keyboard directly with the PC. Refer to the instruction of the PC for details.</p>

10. CLEANING

Periodic cleaning is recommended to keep the monitor looking new and to prolong its operation lifetime.

WARNING

✓ **Keep liquids away from the monitor.**

Spillage into the cabinet may result in fire, electric shock, or equipment damage.

If an object or liquid falls/spills into the cabinet, unplug the monitor immediately. Have the monitor checked by a qualified service engineer before using it again.



CAUTION

✓ **Unplug the monitor before cleaning it.**

Cleaning the monitor while it is plugged into a power outlet may result in electric shock.

✓ **Never use thinner, benzene, alcohol (ethanol, methanol, or isopropyl alcohol), abrasive cleaners, or other strong solvents, as these may cause damage to the cabinet or LCD panel.**



✓ **Periodically clean the area around the plug.**

Buildup of dust water, or oil on the plug may result in fire.

Cabinet

To remove stains, wipe the cabinet with a soft, lightly moistened cloth using a mild detergent. Do not spray wax or cleaner directly onto the cabinet.

LCD Panel

The LCD surface can be cleaned with a soft cloth, such as cotton or lens paper.

If necessary, stubborn stains can be removed by moistening part of a cloth with water to enhance its cleaning power.

11. SPECIFICATIONS

L371

LCD Panel	38 cm (15.0 inch), TFT color LCD panel with Anti-Glare Hard Coating Viewing Angle: Horizontal: 120°, Vertical: 140° (at Contrast Ratio > 5)
Dot Pitch	0.297 mm
Scan Frequency	Horizontal: 27 kHz - 61 kHz (Automatic) Vertical: 50 Hz-85 Hz (Automatic) (1024 x 768: up to 75 Hz) Vertical(Digital): 60Hz, (VGA Text : 70Hz)
Resolution	1024 dots x 768 lines
Dot Clock (Max.)	80 MHz
Display Colors	16 milion colors (max)
Display Area	304 mm (H) x 228 mm (V) (11.9" (H) x 8.9" (V)) (Viewable image size: 380 mm (14.9"))
Power Supply	100-120/220-240 VAC±10%, 50/60 Hz, 0.8 A/0.5 A
Power Consumption	Normal/Max.: 30 W/45 W* Power Saving Mode: Less than 5 W (When the USB hub is not connected)
Input Connector	DVI-I, D-Sub mini 15 pin
Input Signal	Sync: a) Separate, TTL, Positive/Negative b) Composite, TTL, Positive/Negative c) Sync on Green, 0.3 Vp-p, Negative Video: 0.7 Vp-p/75 Ω, Positive (Digital: TMDS (Single Link))
Signal registration	28 (Factory preset: 15)(Digital: 5 (Factory preset: 0))
Plug & Play	VESA DDC 2B
Dimensions	397 mm (W) x 397 mm (H) x 193 mm (D) (15.6" (W) x 15.6" (H) x 7.6" (D))
Dimensions (without stand)	397 mm (W) x 319 mm (H) x 77 mm (D) (15.6" (W) x 12.6" (H) x 3.0" (D))
Weight	5.7 kg (12.6 lbs.)
Weight (without stand)	4.3 kg (9.5 lbs.)
Temperature	operating: 0°C to 35°C (32°F to 95°F) storage: -20°C to 60°C (-4°F to 140°F)
Humidity	30% to 80% R.H. Non-condensing
USB specification	
USB standard	Rev. 1.1 complied self-powered hub
Communication speed	12 Mbps (full), 1.5 Mbps (low)
Downstream power supply	500 mA for each (Max.)
USB ports	Upstream port x 1, Downstream port x 2

* With EIZO optional speaker & USB attached.

L671

LCD Panel	46 cm (18.1 inch), TFT color LCD panel with Anti-Glare Hard Coating Viewing Angle: Horizontal: 170°, Vertical: 170° (at Contrast Ratio > 10)
Dot Pitch	0.28 mm
Scan Frequency	Horizontal: 27 kHz - 82 kHz (Automatic) Vertical: 50 Hz-85 Hz (Automatic) (1280 x 1024: up to 75 Hz) Vertical(Digital): 60Hz, (VGA Text : 70Hz)
Resolution	1280 dots x 1024 lines
Dot Clock (Max.)	Analog: 135 MHz (Digital: 108 MHz)
Display Colors	16 milion colors (max)
Display Area	359 mm (H) x 287 mm (V) (14.1" (H) x 11.3" (V)) (Viewable image size: 459 mm (18.07"))
Power Supply	100-120/220-240 VAC±10%, 50/60 Hz, 0.7 A/0.4 A
Power Consumption	Normal/Max.: 50 W/72 W* Power Saving Mode: Less than 5 W (When the USB hub is not connected)
Input Connector	DVI-I, D-Sub mini 15 pin
Input Signal	Sync: a) Separate, TTL, Positive/Negative b) Composite, TTL, Positive/Negative c) Sync on Green, 0.3 Vp-p, Negative Video: 0.7 Vp-p/75 Ω, Positive (Digital: TMDS (Single Link))
Signal registration	28 (Factory preset: 22)(Digital: 5 (Factory preset: 0))
Plug & Play	VESA DDC 2B
Dimensions	430 mm (W) x 455 mm (H) x 218 mm (D) (16.9" (W) x 17.9" (H) x 8.6" (D))
Dimensions (without stand)	430 mm (W) x 375 mm (H) x 87 mm (D) (16.9" (W) x 14.8" (H) x 3.4" (D))
Weight	9.0 kg (19.8 lbs.)
Weight (without stand)	7.2 kg (15.9 lbs.)
Temperature	operating: 0°C to 35°C (32°F to 95°F) storage: -20°C to 60°C (-4°F to 140°F)
Humidity	30% to 80% R.H. Non-condensing
USB specification	
USB standard	Rev. 1.1 complied self-powered hub
Communication speed	12 Mbps (full), 1.5 Mbps (low)
Downstream power supply	500 mA for each (Max.)
USB ports	Upstream port x 1, Downstream port x 4

* With EIZO optional speaker & USB attached.

Default setting

Default setting are as follows:

•Contrast	80 %
•Brightness	100 %
•Smoothing	3
•Color	Mode 1/Normal white
•PowerManager	VESA DPMS
•Screen Size	Normal
•Input Priority	Signal 1
•Off Timer	Disable
•Beep	On
•Language	English

[Digital]

•Brightness	100 %
•Smoothing	3
•PowerManager	DVI DMPM
•Screen Size	Normal
•Input Priority	Signal 1
•Off Timer	Disable
•Beep	On
•Language	English

Beeper settings

Short beep	<ul style="list-style-type: none"> · ScreenManager item selected. · ScreenManager parameter adjusted to minimum or maximum limit. · Input signal selection button pressed.
Long beep	<ul style="list-style-type: none"> · Auto Adjustment button pressed. · ScreenManager data-save executed.
4 short beeps	<ul style="list-style-type: none"> · Monitor not connected correctly. · PC turned off. · Monitor received unsupported signal frequency.
2 short beeps every 15 sec.	<ul style="list-style-type: none"> · Monitor is in the advance notice mode of the Off Timer. The power will be off within fifteen minutes.

12. GLOSSARY

Afterimage

The Afterimage is particular to LCD monitors when the monitor screen is left on for a long period without use. The “Afterimage” can be removed gradually by changing the displayed image.

Clock

With the analog input signal display, the analog signal is converted to a digital signal by the LCD circuitry. To convert the signal correctly, the LCD monitor needs to produce the same number clock pulse as the dot clock of the graphics system. When the clock pulse is not correctly set, some vertical bars of distortion are displayed on the screen.

DVI

(Digital Visual Interface)

A digital flat panel interface. DVI can transmit digital data from the PC directly without loss with the signal transition method “TMDS”. There are two kinds of DVI connectors. One is DVI-D connector for digital signal input only. The other is DVI-I connector for both digital and analog signal inputs.

DVI-DMPM

(DVI Digital Monitor Power Management)

The Power management system for the digital interface. The “Monitor ON” status (operation mode) and the “Active Off” status (power-saving mode) are indispensable for the DVI-DMPM as the monitor’s power mode.

EIZO MPMS

EIZO MPMS, “EIZO Monitor PowerManager Signaling”, also enables power saving on the monitor side. EIZO MPMS recognizes video signals from the PC when the PC is in a power saving mode, and reduces energy consumption of the monitor.

Gain Adjustment

Adjusts each color parameter for red, green and blue. The color of the LCD monitor is displayed through the color filter of the LCD panel. Red, green and blue are the three primary colors. The colors on the monitor are displayed by combining these three colors. The color tone can change by adjusting the illumination amount passed through each color’s filter.

Phase

The phase adjustment decides the sampling timing point for converting the analog input signal to a digital signal. Adjusting the phase after the clock adjustment will produce a clear screen.

Resolution

The LCD panel consists of a fixed number of pixel elements which are illuminated to form the screen image.

The EIZO L371 display panel consists of 1024 horizontal pixels and 768 vertical pixels, and the L671 consists of 1280 horizontal pixels and 1024 vertical pixels. At a resolution of 1024 X 768 (L371)/1280 X 1024 (L671), all pixels are used and the image is displayed as a full screen. At the lower display modes of 640 x 480 or 800 x 600, the images are displayed in the center of the screen using a smaller portion of the pixels.

TMDS

(Transition Minimized Differential Signaling)

A signal transition method for the digital interface.

VESA DPMS

The acronym VESA stands for “Video Electronics Standards Association,” and DPMS stands for “Display Power Management Signaling.” DPMS is a communication standard that PCs and graphics boards use to implement power savings on the monitor side.

13. INDEX

- A**
 - ADJUSTMENT ----- 21
 - ADJUSTMENT FOR DIGITAL ----- 29
 - Adjustment Lock ----- 20
 - Afterimage ----- 20,46
 - ATTACHING AN ARM STAND ----- 36
- B**
 - Beep ----- 19
 - Beeper setting ----- 45
 - Before connecting ----- 14
 - Border Intensity ----- 19, 25
 - Brightness ----- 19, 24
- C**
 - CABLE CONNECTION ----- 14
 - CLEANING ----- 42
 - Clock ----- 19, 22, 46
 - Color ----- 19, 27
 - Color adjustment ----- 27
 - Color mode ----- 19, 27
 - CONNECTING TWO PCs to
THE MONITOR -- 34
 - Contrast ----- 19, 24
 - Controls & Connectors ----- 12
- D**
 - Default setting ----- 45
 - Dimensions ----- i
 - Digital input connection ----- 17
 - Displaying the low resolutions ----- 25
 - DVI ----- 10, 46
 - DVI DMPM ----- 19, 31, 46
- E**
 - EIZO LCD utility disk ----- 11, 21
 - EIZO MPMS ----- 19, 28, 46
- G**
 - Gain ----- 19, 27, 46
 - GLOSSARY ----- 46
- H**
 - How to use the ScreenManager ----- 18
- I**
 - Information ----- 19
 - Input Priority ----- 19, 34
- L**
 - Language ----- 19
- M**
 - MAKING USE OF USB
(Universal Serial Bus) --- 32
 - Menu Position ----- 19
- O**
 - Off timer ----- 19, 20
 - Others ----- 19
- P**
 - Package Contents ----- 11
 - Phase ----- 19, 22, 47
 - Pin Assignment ----- ii
 - Position ----- 19, 23
 - Power consumption ----- 28, 31, 43, 44
 - Power Indicator ----- 12
 - PowerManager ----- 19, 28, 31
 - Power-save Setup ----- 28, 31
 - PRECAUTIONS ----- 4
 - Preset Timing Chart ----- iii
- R**
 - Reset ----- 19
 - Resolution --- 14, 17, 19, 23, 43, 44, 47
- S**
 - Save ----- 18, 19, 27
 - Screen ----- 19, 21
 - Screen Adjustment ----- 21
 - Screen Size ----- 19, 25
 - ScreenManager ----- 18
 - ScreenManager Adjustments
and Settings ----- 19
 - Security Lock Slot ----- 13
 - Smoothing ----- 19, 26
 - SPECIFICATIONS ----- 43
- T**
 - TMDS ----- 10, 47
 - TROUBLE SHOOTING ----- 38
- U**
 - USB ----- 28, 32, 43, 44
- V**
 - VESA DPMS ----- 19, 28, 47

APPENDIX / ANHANG / ANNEXE

Dimensions Abmessungen Dimensions

L371

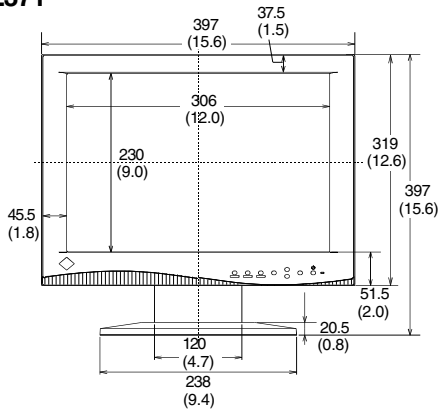

FRONT VIEW
VORDERANSICHT
VUE DE FACE

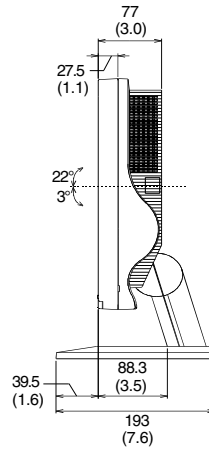

SIDE VIEW
SEITENANSICHT
VUE DE COTE

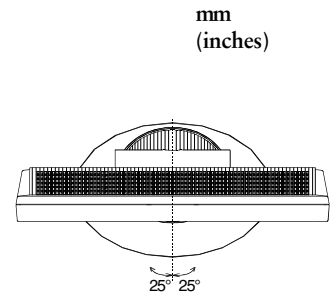

TOP VIEW
DRAUFSICHT
VUE D'EN HAUT

L671

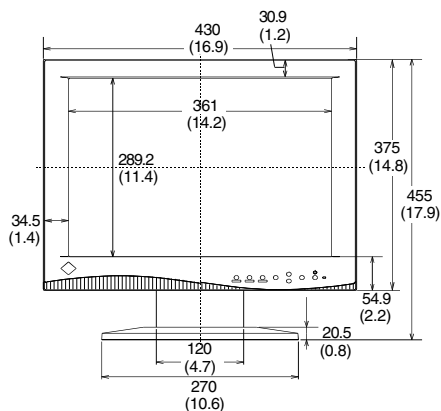

FRONT VIEW
VORDERANSICHT
VUE DE FACE

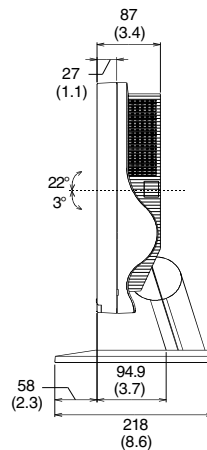

SIDE VIEW
SEITENANSICHT
VUE DE COTE

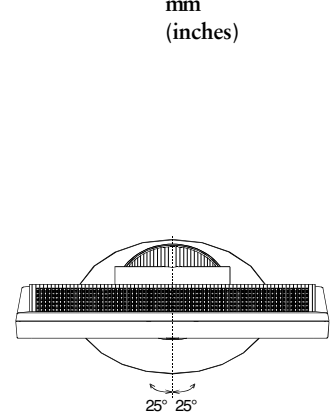

TOP VIEW
DRAUFSICHT
VUE D'EN HAUT

Pin Assignment Pin-Belegung Affectation des Broches

* D-Sub mini 15 pin connector

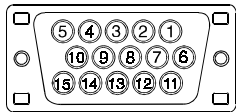

Pin No.	Signal	Pin No.	Signal
1	Red video	9	No pin
2	Green video/ Green video Composite Sync	10	Ground Shorted
		11	
3	Blue video	12	Data (SDA)
4	Ground	13	H. Sync/H. V. Composite Sync
5	No pin		
6	Red ground	14	V. Sync
7	Green ground	15	Clock (SCL)
8	Blue ground		

* DVI-I Connector

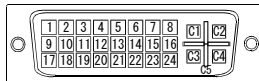

Pin No.	Signal	Pin No.	Signal	Pin No.	Signal
1	TMDS Data2-	11	TMDS Data1/3 Shield	21	NC
2	TMDS Data2+	12	NC	22	TMDS Clock Shield
3	TMDS Data2/4 Shield	13	NC	23	TMDS Clock+
4	NC*	14	+5V Power	24	TMDS Clock-
5	NC	15	Ground (return for +5V, Hsync and Vsync)	C1	Analog Red
6	DDC Clock (SCL)	16	Hot Plug Detect	C2	Analog Green
7	DDC Data (SDA)	17	TMDS Data0-	C3	Analog Blue
8	Analog Vertical Sync	18	TMDS Data0+	C4	Analog Horizontal Sync
9	TMDS Data1-	19	TMDS Data0/5 Shield	C5	Analog Ground (analog R,G,&B return)
10	TMDS Data1+	20	NC		

(*NC: No Connection)

* USB ports

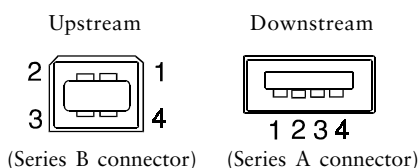

No.	Signal	Comments
1	VCC	Cable power
2	- Data	Serial data
3	+ Data	Serial data
4	Ground	Cable Ground

Preset Timing Chart for Analog input Timing-Übersichten für Analog Eingang Synchronisation des Signaux pour Analog numerique

Based on the signal diagram shown below, 15 factory presets for L371 and 22 factory presets for L671 have been registered in the monitor's microprocessor.

Der integrierte Mikroprozessor des Monitors unterstützt 15 (L371), 22(L671) werkseitige Standardeinstellungen (siehe hierzu die nachfolgenden Diagramme).

15(L371), 22(L671) signaux ont été enregistrés en usine dans le microprocesseur du moniteur, conformément au diagramme de synchronisation ci-dessous.

A	Front Porch	Vordere Schwarzschulter	Front avant
B	Sync Period	Synchronimpuls	Délai de synchronisation
C	Back Porch	Hintere Schwarzschulter	Front arrière
D	Blanking Period	Austastzeit	Délai de clignotement
E	Display period	Display-Zeit	Délai d'affichage
F	Total cycle	Kompletter Zyklus	Cycle total
H	Sync signal level	Sync-Signalpegel	Niveau du signal de synchronisation
V	Video signal level	Video-Signalpegel	Niveau du signal vidéo

Mode	Dot Clock MHz	Frequencies		A: Front Porch		B: Sync Period	
		H kHz	V Hz	H μs/ Dot	V ms/ Line	H μs/ Dot	V ms/ Line
VGA * 640 x 480	25.175	31.468	59.941	0.636/ 16	0.318/ 10	3.813/ 96	0.054/ 2
VGA * 720 x 400	28.322	31.468	70.087	0.636/ 18	0.381/ 12	3.813/ 108	0.064/ 2
Macintosh * 640 x 480	30.24	35.00	66.67	2.116/ 64	0.086/ 3	2.116/ 64	0.086/ 3
Macintosh * 832 x 624	57.28	49.73	74.55	0.559/ 32	0.020/ 1	1.117/ 64	0.060/ 3
Macintosh 1152 x 870	100.0	68.68	75.06	0.320/ 32	0.044/ 3	1.280/ 128	0.044/ 3
VESA * 640 x 480	31.5	37.86	72.81	0.508/ 24	0.026/ 9	1.270/ 40	0.079/ 3
VESA * 640 x 480	31.5	37.5	75.00	0.508/ 16	0.027/ 1	2.032/ 67	0.080/ 3
VESA * 640 x 480	36.0	43.27	85.01	1.556/ 56	0.023/ 1	1.556/ 56	0.069/ 3
VESA * 800 x 600	36.0	35.16	56.25	0.667/ 24	0.028/ 1	2.000/ 72	0.057/ 2
VESA * 800 x 600	40.0	37.88	60.32	1.000/ 40	0.026/ 1	3.200/ 128	0.106/ 4
VESA * 800 x 600	50.0	48.08	72.19	1.120/ 56	0.770/ 37	2.400/ 120	0.125/ 6
VESA * 800 x 600	49.5	46.88	75.00	0.323/ 16	0.021/ 1	1.616/ 80	0.064/ 3
VESA * 800 x 600	56.25	53.674	85.061	0.569/ 32	0.019/ 1	1.138/ 64	0.056/ 3
VESA * 1024 x 768	65.0	48.36	60.00	0.369/ 24	0.062/ 3	2.092/ 136	0.124/ 6
VESA * 1024 x 768	75.0	56.48	70.07	0.320/ 24	0.053/ 3	1.813/ 136	0.106/ 6
VESA * 1024 x 768	78.75	60.02	75.03	0.203/ 16	0.017/ 1	1.219/ 96	0.050/ 3
VESA 1024 x 768	94.5	68.68	85.0	0.508/ 48	0.015/ 1	1.016/ 96	0.044/ 3
Workstation 1152 x 900	94.2	61.974	66.141	0.425/ 40	0.032/ 2	1.359/ 128	0.065/ 4
Workstation 1152 x 900	107.50	71.858	76.202	0.223/ 24	0.028/ 2	1.265/ 136	0.111/ 8
Macintosh 1280 x 960	126.2	74.763	74.763	0.190/ 24	0.013/ 1	1.204/ 152	0.040/ 3
VESA 1280 x 1024	108.0	63.98	60.02	0.444/ 48	0.016/ 1	1.037/ 112	0.047/ 3
VESA 1280 x 1024	135.0	79.97	75.02	0.119/ 16	0.013/ 1	1.067/ 144	0.038/ 3

* L371 Preset Timing

C: Back Porch		D: Blanking Period		E: Display Period		F: Total Cycle	
H μs/ Dot	V ms/ Line	H μs/ Dot	V ms/ Line	H μs/ Dot	V ms/ Line	H μs/ Dot	V ms/ Line
1.907/ 48	1.048/ 33	6.356/ 160	1.430/ 45	25.442/ 640	15.254/ 480	31.778/ 800	16.683/ 525
1.907/ 54	1.111/ 35	6.356/ 180	1.556/ 49	25.422/ 720	12.712/ 400	31.778/ 900	14.267/ 449
3.175/ 96	1.114/ 39	7.407/ 224	1.286/ 45	21.164/ 640	13.714/ 480	28.571/ 864	15.000/ 525
3.911/ 224	0.784/ 39	5.586/ 320	0.865/ 43	14.524/ 832	12.549/ 624	20.111/ 1152	13.414/ 667
1.440/ 144	0.568/ 39	3.040/ 304	0.655/ 45	11.520/ 1152	12.667/ 870	14.560/ 1456	13.322/ 915
3.810/ 128	0.528/ 28	5.587/ 192	0.634/ 40	20.317/ 640	12.678/ 480	26.413/ 832	13.735/ 520
3.810/ 120	0.427/ 16	6.349/ 200	0.533/ 20	20.317/ 640	12.800/ 480	26.667/ 840	13.333/ 500
2.222/ 80	0.578/ 25	5.333/ 192	0.670/ 29	17.778/ 640	11.093/ 480	23.111/ 832	11.764/ 509
3.556/ 128	0.626/ 22	6.222/ 224	0.711/ 25	22.222/ 800	17.067/ 600	28.444/ 1024	17.778/ 625
2.200/ 88	0.607/ 23	6.400/ 256	0.739/ 28	20.000/ 800	15.840/ 600	26.400/ 1056	16.579/ 628
1.280/ 64	0.478/ 23	4.800/ 240	1.373/ 66	16.000/ 800	12.480/ 600	20.800/ 1040	13.853/ 666
3.232/ 160	0.448/ 21	5.172/ 256	0.533/ 25	16.162/ 800	12.800/ 600	21.333/ 1056	13.333/ 625
2.702/ 152	0.503/ 27	4.409/ 248	0.578/ 31	14.222/ 800	11.179/ 600	18.631/ 1048	11.756/ 631
2.462/ 160	0.600/ 29	4.923/ 320	0.786/ 38	15.754/ 1024	15.880/ 768	20.677/ 1344	16.666/ 806
19.20/ 144	0.513/ 29	4.053/ 304	0.673/ 38	13.653/ 1024	16.599/ 768	17.707/ 1328	14.272/ 806
2.235/ 176	0.466/ 28	3.657/ 288	0.533/ 32	13.003/ 1024	12.795/ 768	16.660/ 1312	13.328/ 800
2.201/ 208	0.524/ 36	3.725/ 352	0.582/ 40	10.836/ 1024	11.183/ 768	14.561/ 1376	11.765/ 808
2.123/ 200	0.500/ 31	3.907/ 368	0.597/ 37	12.229/ 1152	14.522/ 900	16.136/ 1520	15.119/ 937
1.712/ 184	0.459/ 33	3.200/ 344	0.598/ 43	10.716/ 1152	12.525/ 900	13.916/ 1496	13.123/ 943
1.838/ 232	0.482/ 36	3.233/ 408	0.535/ 40	10.143/ 1280	12.841/ 960	13.376/ 1688	13./376 1000
2.296/ 248	0.594/ 38	3.778/ 408	0.656/ 42	11.852/ 1280	16.005/ 1024	15.630/ 1688	16.661/ 1066
1.837/ 248	0.475/ 38	3.022/ 408	0.525/ 42	9.481/ 1280	12.804/ 1024	12.504/ 1688	13.329/ 1066

[Applicable to gray (standard color version only).]



Congratulations!

You have just purchased a TCO'99 approved and labelled product! Your choice has provided you with a product developed for professional use. Your purchase has also contributed to reducing the burden on the environment and also to the further development of environmentally adapted electronics products.

Why do we have environmentally labelled computers?

In many countries, environmental labelling has become an established method for encouraging the adaptation of goods and services to the environment. The main problem, as far as computers and other electronics equipment are concerned, is that environmentally harmful substances are used both in the products and during their manufacture. Since it is not so far possible to satisfactorily recycle the majority of electronics equipment, most of these potentially damaging substances sooner or later enter nature.

There are also other characteristics of a computer, such as energy consumption levels, that are important from the viewpoints of both the work (internal) and natural (external) environments. Since all methods of electricity generation have a negative effect on the environment (e.g. acidic and climate-influencing emissions, radioactive waste), it is vital to save energy. Electronics equipment in offices is often left running continuously and thereby consumes a lot of energy.

What does labelling involve?

This product meets the requirements for the TCO'99 scheme which provides for international and environmental labelling of personal computers. The labelling scheme was developed as a joint effort by the TCO (The Swedish Confederation of Professional Employees), Svenska Naturskyddsforeningen (The Swedish Society for Nature Conservation) and Statens Energimyndighet (The Swedish National Energy Administration).

Approval requirements cover a wide range of issues: environment, ergonomics, usability, emission of electric and magnetic fields, energy consumption and electrical and fire safety.

The environmental demands impose restrictions on the presence and use of heavy metals, brominated and chlorinated flame retardants, CFCs (freons) and chlorinated solvents, among other things. The product must be prepared for recycling and the manufacturer is obliged to have an environmental policy which must be adhered to in each country where the company implements its operational policy.

The energy requirements include a demand that the computer and/or display, after a certain period of inactivity, shall reduce its power consumption to a lower level in one or more stages. The length of time to reactivate the computer shall be reasonable for the user.

Labelled products must meet strict environmental demands, for example, in respect of the reduction of electric and magnetic fields, physical and visual ergonomics and good usability.

Below you will find a brief summary of the environmental requirements met by this product.

The complete environmental criteria document may be ordered from:

TCO Development

SE-114 94 Stockholm, Sweden

Fax: +46 8 782 92 07

Email (Internet): development@tco.se

Current information regarding TCO'99 approved and labelled products may also be obtained via the Internet, using the address: <http://www.tco-info.com/>

[Applicable to gray (standard color version only).]

Environmental requirements

Flame retardants

Flame retardants are present in printed circuit boards, cables, wires, casings and housings. Their purpose is to prevent, or at least to delay the spread of fire. Up to 30% of the plastic in a computer casing can consist of flame retardant substances. Most flame retardants contain bromine or chloride, and those flame retardants are chemically related to another group of environmental toxins, PCBs. Both the flame retardants containing bromine or chloride and the PCBs are suspected of giving rise to severe health effects, including reproductive damage in fish-eating birds and mammals, due to the bio-accumulative* processes. Flame retardants have been found in human blood and researchers fear that disturbances in foetus development may occur.

The relevant TCO'99 demand requires that plastic components weighing more than 25 grams must not contain flame retardants with organically bound bromine or chlorine. Flame retardants are allowed in the printed circuit boards since no substitutes are available.

Cadmium**

Cadmium is present in rechargeable batteries and in the colour-generating layers of certain computer displays. Cadmium damages the nervous system and is toxic in high doses. The relevant TCO'99 requirement states that batteries, the colour-generating layers of display screens and the electrical or electronics components must not contain any cadmium.

Mercury**

Mercury is sometimes found in batteries, relays and switches. It damages the nervous system and is toxic in high doses. The relevant TCO'99 requirement states that batteries may not contain any mercury. It also demands that mercury is not present in any of the electrical or electronics components associated with the labelled unit.

CFCs (freons)

The relevant TCO'99 requirement states that neither CFCs nor HCFCs may be used during the manufacture and assembly of the product. CFCs (freons) are sometimes used for washing printed circuit boards. CFCs break down ozone and thereby damage the ozone layer in the stratosphere, causing increased reception on earth of ultraviolet light with e.g. increased risks of skin cancer (malignant melanoma) as a consequence.

Lead**

Lead can be found in picture tubes, display screens, solders and capacitors. Lead damages the nervous system and in higher doses, causes lead poisoning. The relevant TCO'99 requirement permits the inclusion of lead since no replacement has yet been developed.

* Bio-accumulative is defined as substances which accumulate within living organisms.

** Lead, Cadmium and Mercury are heavy metals which are Bio-accumulative.

For U.S.A, Canada, etc. (rated 100-120 Vac) Only

FCC Declaration of Conformity

We, the Responsible Party EIZO NANA O TECHNOLOGIES INC.
5710 Warland Drive, Cypress, CA 90630
Phone: (562) 431-5011

declare that the product Trade name: EIZO
Model: FlexScan L371, L671

is in conformity with Part 15 of the FCC Rules. Operation of this product is subject to the following two conditions: (1) this device may not cause harmful interference, and (2) this device must accept any interference received, including interference that may cause undesired operation.

This equipment has been tested and found to comply with the limits for a Class B digital device, pursuant to Part 15 of the FCC Rules. These limits are designed to provide reasonable protection against harmful interference in a residential installation. This equipment generates, uses, and can radiate radio frequency energy and, if not installed and used in accordance with the instructions, may cause harmful interference to radio communications. However, there is no guarantee that interference will not occur in a particular installation. If this equipment does cause harmful interference to radio or television reception, which can be determined by turning the equipment off and on, the user is encouraged to try to correct the interference by one or more of the following measures.

- *Reorient or relocate the receiving antenna.
- *Increase the separation between the equipment and receiver.
- *Connect the equipment into an outlet on a circuit different from that to which the receiver is connected.
- *Consult the dealer or an experienced radio/TV technician for help.

Changes or modifications not expressly approved by the party responsible for compliance could void the user's authority to operate the equipment.

Note

Use the attached specified cable below or EIZO signal cable with this monitor so as to keep interference within the limits of a Class B digital device.

- AC Cord
- Shielded Signal Cable (D-SUB mini 15 pin - D-SUB mini 15 pin, the enclosed signal cable)

Canadian Notice

This Class B digital apparatus complies with Canadian ICES-003.

Cet appareil numérique de la classe B est conforme à la norme NMB-003 du Canada.

For Europe, etc. (220-240 Vac) Only

CE Marking

Declaration of Conformity

Kind of equipment: Monitor
Type-designation: L371/L671

is in compliance with:

Council Directive 73/23/EEC EN60950: 1992+A1+A2+A3+A4+A11
Council Directive 89/336/EEC EN55022 (class B): 1998 EN50082-1: 1992
EN61000-3-2: 1995+A1+A2 EN61000-3-3: 1995

Konformitätserklärung

Geräteart : Monitor
Gerätetyp : L371/L671

den folgenden Normen oder Vorschriften entspricht:

EU-Richtlinie 73/23/EEC EN60950: 1992+A1+A2+A3+A4+A11
EU-Richtlinie 89/336/EEC EN55022 (class B): 1998 EN50082-1: 1992
EN61000-3-2: 1995+A1+A2 EN61000-3-3: 1995

Déclaration de conformité

Nature de l'équipement : Moniteur
Type-désignation : L371/L671

est en conformité avec :

Directive Européenne 73/23/EEC EN60950: 1992+A1+A2+A3+A4+A11
Directive Européenne 89/336/EEC EN55022 (class B): 1998 EN50082-1: 1992
EN61000-3-2: 1995+A1+A2 EN61000-3-3:1995

Hinweis zur Ergonomie :

Dieser Monitor erfüllt die Anforderungen an die Ergonomie nach EK1/59-98, EK1/60-98 mit dem Videosignal, L371: 1024 Punkte x 768 Zeilen / L671: 1280 Punkte x 1024 Zeilen, RGB analog, 0,7 Vp-p und mindestens 75,0 Hz Bildwiederholffrequenz, non interlaced. Weiterhin wird aus ergonomischen Gründen empfohlen, die Grundfarbe Blau nicht auf dunklem Untergrund zu verwenden (schlechte Erkennbarkeit, Augenbelastung bei zu geringem Zeichenkontrast.)

Recycle Auskunft

Die Rücknahme dieses Produktes nach Nutzungsende übernimmt EIZO in Deutschland zusammen mit dem Partner von Roll MBB Recycling GmbH. Dort werden die Geräte in ihre Bestandteile zerlegt, die dann der Wiederverwertung zugeführt werden. Um einen Abholtermin zu vereinbaren und die aktuellen Kosten zu erfahren, benutzen Sie bitte folgende Rufnummer: 02153-73 35 00. Weitere Informationen finden Sie auch unter der Internet-Adresse: www.eizo.de.