

# User's Manual

## FlexScan<sup>®</sup> S2232W S2242W S2432W Color LCD Monitor

### Important

Please read PRECAUTIONS, this User's Manual and Setup Guide (separate volume) carefully to familiarize yourself with safe and effective usage.

- 
- Please read the Setup Guide (separate volume)
  - The latest User's Manual is available for download from our site:  
<http://www.eizo.com>
- 



## [Location of Caution Statement]

Ex. Height adjustable stand

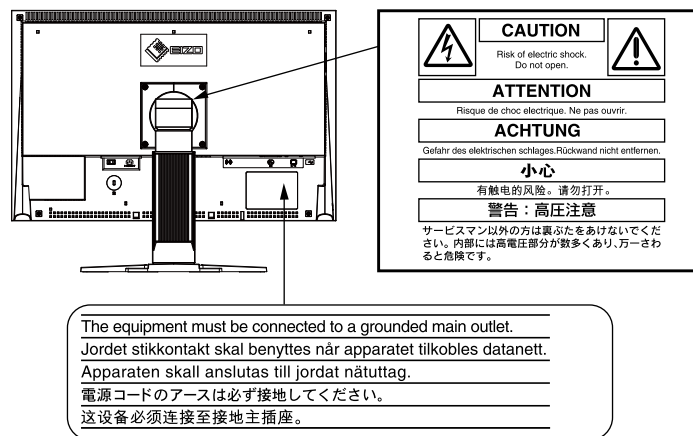

Product specification may vary with sales areas.

Confirm the specification in the manual written in language of the region of purchase.

---

Copyright© 2009-2010 EIZO NANA O CORPORATION All rights reserved.

No part of this manual may be reproduced, stored in a retrieval system, or transmitted, in any form or by any means, electronic, mechanical, or otherwise, without the prior written permission of EIZO NANA O CORPORATION.

EIZO NANA O CORPORATION is under no obligation to hold any submitted material or information confidential unless prior arrangements are made pursuant to EIZO NANA O CORPORATION's receipt of said information.

Although every effort has been made to ensure that this manual provides up-to-date information, please note that EIZO monitor specifications are subject to change without notice.

---

Apple and Macintosh are registered trademarks of Apple Inc.

VGA is a registered trademark of International Business Machines Corporation.

VESA is a registered trademark or a trademark of Video Electronics Standards Association in the United States and other countries.

Windows and Windows Vista are registered trademarks of Microsoft Corporation in the United States and other countries.

EIZO, EIZO Logo, FlexScan, i•Sound and ScreenManager are registered trademarks of EIZO NANA O CORPORATION in Japan and other countries.

All other trademarks are the properties of their respective owners.

---

## Notice for this monitor

---

This product is suited to creating documents, viewing multimedia content, and other general purposes.

---

This product has been adjusted specifically for use in the region to which it was originally shipped. If the product is used outside the region, it may not operate as specified in the specifications.

---

This product may not be covered by warranty for uses other than those described in this manual.

---

The specifications noted in this manual are only applicable for power cords and signal cables specified by us.

---

Use optional products manufactured or specified by us with this product.

---

As it takes about 30 minutes for the performance of electrical parts to stabilize, adjust the monitor 30 minutes or more after the monitor power has been turned on.

---

In order to suppress the luminosity change by long-term use and to maintain the stable luminosity, use of a monitor in lower brightness is recommended.

---

When the screen image is changed after displaying the same image for extended periods of time, an afterimage may appear. Use the screen saver or timer to avoid displaying the same image for extended periods of time.

---

Periodic cleaning is recommended to keep the monitor looking new and to prolong its operation lifetime.  
(Refer to “[Cleaning](#)” on the next page.)

---

The LCD panel is manufactured using high-precision technology. However, missing pixels or lit pixels may appear on the LCD panel, this is not malfunction.

Percentage of effective pixels : 99.9994% or higher.

---

The backlight of the LCD panel has a fixed life span. When the screen becomes dark or begins to flicker, please contact your dealer.

---

Do not press on the panel or edge of the frame strongly, as this may result in the display malfunction, such as the interference patterns, etc. If pressure is continually applied to the LCD panel, it may deteriorate or damage your LCD panel. (If the pressure marks remain on the LCD panel, leave the monitor with a white or black screen. The symptom may disappear.)

---

Do not scratch or press on the panel with any sharp objects, such as a pencil or pen as this may result in damage to the panel. Do not attempt to brush with tissues as this may scratch the LCD panel.

---

When the monitor is cold and brought into a room or the room temperature goes up quickly, dew condensation may occur inside and outside the monitor. In that case, do not turn the monitor on and wait until dew condensation disappears, otherwise it may cause some damages to the monitor.

---

---

## Cleaning

---

### Attention

- Never use any solvents or chemicals, such as thinner, benzene, wax, alcohol, and abrasive cleaner, which may damage the cabinet or LCD panel.
- 

### NOTE

- Optional ScreenCleaner is recommended for cleaning the panel surface.
- 

### [LCD Panel]

- Clean the LCD panel with a soft cloth such as cotton cloth or lens cleaning paper.
- Remove persistent stains gently with a cloth dampened with a little water, and then clean the LCD panel again with a dry cloth for better finishing.

### [Cabinet]

Clean the cabinet with a soft cloth dampened with a little mild detergent.

## To use the monitor comfortably

---

- An excessively dark or bright screen may affect your eyes. Adjust the brightness of the monitor according to the environmental conditions.
- Staring at the monitor for a long time tires your eyes. Take a 10-minute rest every hour.

# CONTENTS

Notice for this monitor .....	3		
<b>CONTENTS</b> .....	<b>5</b>		
<b>Chapter 1 Features and Overview</b> .....	<b>7</b>		
1-1 Features .....	7		
1-2 Controls and Functions .....	8		
1-3 Compatible Resolutions/Frequencies .....	9		
1-4 Functions and Basic Operation .....	10		
<b>Chapter 2 Settings and Adjustments</b> .....	<b>13</b>		
2-1 Utility Disk .....	13		
• Disk contents and software overview .....	13		
• To use ScreenManager Pro for LCD .....	13		
2-2 Screen Adjustment .....	14		
Digital Input .....	14		
Analog Input .....	14		
2-3 Color Adjustment .....	17		
• To select the display mode (FineContrast mode) ...	17		
• To perform advanced adjustments .....	18		
• Adjustment items in each mode .....	18		
• To adjust the brightness [Brightness] .....	18		
• To adjust the contrast [Contrast] .....	18		
• To adjust the color temperature [Temperature] ...	19		
• To adjust the gamma value [Gamma] .....	19		
• To adjust the color saturation [Saturation] .....	19		
• To adjust the hue [Hue] .....	20		
• To adjust the gain value [Gain] .....	20		
2-4 Adjusting Volume [Volume] .....	20		
2-5 Turning off the audio output at Power Saving mode [Power Save] .....	20		
2-6 Setting On/Off for the automatic brightness adjustment function [Auto EcoView] .....	21		
2-7 Setting On/Off for Power Saving mode [Power Save] .....	21		
2-8 Turning off the monitor automatically [Off Timer] .....	22		
2-9 Displaying the level of power saving by EcoView Index .....	22		
2-10 Screen Size Selection .....	23		
• To change screen size [Screen Size] .....	23		
• To adjust brightness of non-display area [Border Intensity] .....	23		
2-11 Setting Adjustment Menu Display .....	24		
• To update menu settings [Menu Size/Menu Position/Menu Off Timer/Translucent] ....	24		
2-12 Setting Orientation .....	25		
• To set the orientation of the Adjustment menu [Orientation] .....	25		
2-13 Locking Buttons .....	25		
2-14 Displaying Monitor Information [Information] .....	25		
2-15 Enabling/Disabling DDC/CI communication ..	26		
2-16 Setting Power Indicator ON/OFF [Power Indicator] .....	26		
2-17 Setting Language [Language] .....	26		
2-18 Setting EIZO logo display ON/OFF .....	26		
2-19 Resuming the Default Setting [Reset] .....	27		
• To reset color adjustment values .....	27		
• To reset all adjustments to the factory default settings .....	27		
<b>Chapter 3 Connecting Cables</b> .....	<b>28</b>		
3-1 Connecting Two PCs to the Monitor .....	28		
• To switch the input signal .....	28		
• To set input signal selection [Input Signal] .....	29		
3-2 Adjusting the DVI Input Level [DVI Input Level] .....	29		
3-3 Connecting Peripheral USB Devices .....	30		
<b>Chapter 4 Troubleshooting</b> .....	<b>31</b>		

# CONTENTS

---

<b>Chapter 5 Reference .....</b>	<b>34</b>
5-1 Attaching an Arm .....	34
5-2 Folding the EZ-UP stand .....	35
5-3 Specifications .....	36
5-4 Glossary .....	45
5-5 Preset Timing .....	47
<b>TCO'03 .....</b>	<b>48</b>
<b>FCC Declaration of Conformity .....</b>	<b>49</b>
<b>Hinweise zur Auswahl des richtigen Schwenkarms für Ihren Monitor .....</b>	<b>50</b>
<b>Hinweis zur Ergonomie .....</b>	<b>50</b>

# Chapter 1 Features and Overview

Thank you very much for choosing an EIZO color LCD monitor.

## 1-1 Features

- 22" wide format LCD Applicable to WSXGA+ (1680×1050) (S2232W)/  
22" wide format LCD Applicable to WUXGA (1920×1200) (S2242W)/  
24" wide format LCD Applicable to WUXGA (1920×1200) (S2432W)
- Built-in speakers and headphone jack
  - 1-2 "Controls and Functions" ([page 8](#))
- Power saving function
  - Suppressing the power consumption\* reduces the carbon dioxide emissions.
  - This product is equipped with various power saving functions.
    - Power Consumption when main power switch is Off: 0W
      - Equipped with main power switch.
      - Turning off the main power switch completely shuts off power supply to the monitor while the monitor is not used.
    - Auto EcoView function
      - The sensor on the front side of the monitor detects the environmental brightness to adjust the screen brightness automatically and comfortably.
      - Excessively high brightness may lead a damage to the natural environment as well as to your eyes. Suppressing the excessively high brightness will be helpful to reduce the power consumption and the damage to your eyes.
      - 2-6 "Setting On/Off for the automatic brightness adjustment function [Auto EcoView]" ([page 21](#))
    - EcoView Index function
      - The green indicator shows the power consumption ratio responding to the brightness of the monitor. You can realize the power consumption reduction by taking consideration in the ratio of power saving.
      - 2-9 "Displaying the level of power saving by EcoView Index" ([page 22](#))
- FineContrast function
  - 2-3 "To select the display mode (FineContrast mode)" ([page 17](#))
- Applicable to DVI long cable
  - 3-2 "Adjusting the DVI Input Level [DVI Input Level]" ([page 29](#))
- Portrait/Landscape display available
- The software "ScreenManager Pro for LCD" to adjust the screen using the mouse and keyboard is included
  - 2-1 "Utility Disk" ([page 13](#))
- HDCP (High-bandwidth Digital Content Interface)
- \* Reference values:
  - S2232W
    - Maximum power consumption: 80W (Luminance Max., at default settings)
    - Standard power consumption: 32W (Luminance 120cd/m<sup>2</sup>, at default settings)
  - S2242W
    - Maximum power consumption: 80W (Luminance Max., at default settings)
    - Standard power consumption: 36W (Luminance 120cd/m<sup>2</sup>, at default settings)
  - S2432W
    - Maximum power consumption: 90W (Luminance Max., at default settings)
    - Standard power consumption: 40W (Luminance 120cd/m<sup>2</sup>, at default settings)

### NOTE

- This monitor supports the Portrait/Landscape display. This function allows you to change the orientation of the Adjustment menu when using the monitor screen in vertical display position. (Refer to "To set the orientation of the Adjustment menu [Orientation]" on [page 25](#).)
- For using the monitor with "Portrait" position, the graphics board supporting portrait display is required. When placing the monitor in a "Portrait" position, settings of your graphics board need to be changed.
- The stand of the unit can be replaced with an arm or another stand. (Refer to "5-1 Attaching an Arm" on [page 34](#).)

# 1-2 Controls and Functions

Ex. Height adjustable stand

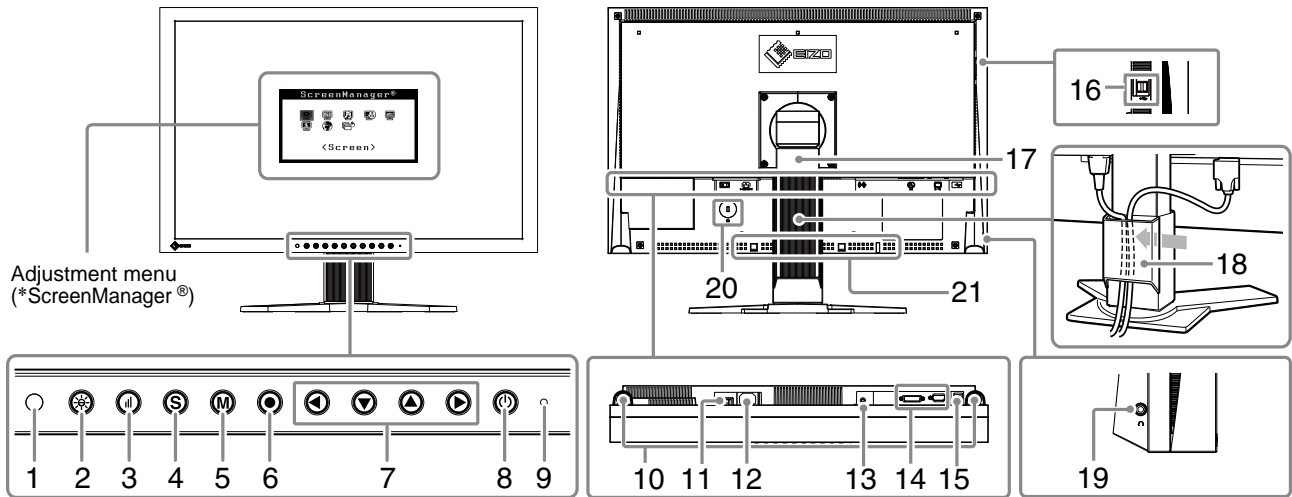

1	<b>Sensor</b>	Detects ambient brightness. Auto EcoView function (page 21).
2	<b>Auto EcoView button</b>	Allows you to switch the Auto EcoView function On or Off (page 21).
3	<b>EcoView Index button</b>	Displays the EcoView index (page 22).
4	<b>Input Signal Selection button</b>	Switches input signals for display when two PCs are connected to the monitor (page 28).
5	<b>Mode button</b>	Allows you to switch the display mode (page 17).
6	<b>Enter button</b>	Displays the Adjustment menu, determines an item on the menu screen, and saves values adjusted (page 12).
7	<b>Control buttons (Left, Down, Up, Right)</b>	<ul style="list-style-type: none"> <li>Chooses an adjustment item or increases/decreases adjusted values for advanced adjustments using the Adjustment menu (page 12).</li> <li>◀ or ▶ button: Displays the volume adjustment menu (page 10).</li> <li>▲ or ▼ button: Displays the brightness adjustment menu (page 10).</li> </ul>
8	<b>Power button</b>	Turns the power on or off.
9	<b>Power indicator</b>	Indicates monitor's operation status. Blue: Operating      Orange: Power saving      Off: Power off
10	<b>Speaker</b>	Outputs audio source.
11	<b>Main Power Switch</b>	Turns the main power on or off.
12	<b>Power connector</b>	Connects the power connector.
13	<b>Stereo mini jack</b>	Connects the stereo mini jack cable.
14	<b>Input signal connectors</b>	Left : DVI-D Connector / Right : D-Sub mini 15-pin connector
15	<b>USB port (Up)</b>	Connects the USB cable to use the software that needs USB connection, or to use USB Hub function. (page 30)
16	<b>USB Port (Down)</b>	Connects a peripheral USB device.
17	<b>Stand</b>	Used to adjust the height and angle of the monitor screen.
18	<b>Cable holder</b>	Covers the monitor cables.
19	<b>Headphone jack</b>	Connects the headphones.
20	<b>Security lock slot</b>	Complies with Kensington's MicroSaver security system.
21	<b>Option speaker (i-Sound L3) mounting holes</b>	Used to attach the option speaker (i-Sound L3). (May not allowed to attach the option speaker depending on the stand type.)

\* ScreenManager® is an EIZO's nickname of the Adjustment menu. See page 10 for how to use.



## 1-3 Compatible Resolutions/Frequencies

The monitor supports the following resolutions.

### Analog Input

Resolution	Frequency	Mode	S2232W	S2242W/S2432W
			Dot Clock ~150MHz	Dot Clock ~202.5MHz
640 × 480	~75 Hz	VGA, VESA	√	√
720 × 400	70 Hz	VGA TEXT	√	√
800 × 600	~75 Hz	VESA	√	√
1024 × 768	~75 Hz	VESA	√	√
1152 × 864	75 Hz	VESA	√	√
1280 × 960	60 Hz	VESA	√	√
1280 × 1024	~75 Hz	VESA	√	√
1600 × 1200	~75 Hz	VESA	–	√
*1 *2 1680 × 1050	60 Hz	VESA CVT, VESA CVT RB	√	√
*1 *3 1920 × 1200	60 Hz	VESA CVT, VESA CVT RB	–	√

### Digital Input

Resolution	Frequency	Mode	S2232W	S2242W/S2432W
			Dot Clock ~120MHz	Dot Clock ~162MHz
640 × 480	60 Hz	VGA	√	√
720 × 400	70 Hz	VGA TEXT	√	√
800 × 600	60 Hz	VESA	√	√
1024 × 768	60 Hz	VESA	√	√
1280 × 960	60 Hz	VESA	√	√
1280 × 1024	60 Hz	VESA	√	√
1600 × 1200	60 Hz	VESA	–	√
*1 1680 × 1050	60 Hz	VESA CVT	–	√
*1 *2 1680 × 1050	60 Hz	VESA CVT RB	√	√
*1 *3 1920 × 1200	60 Hz	VESA CVT RB	–	√

\*1 When displaying the wide format input signal, a graphics board in conformance with VESA CVT standard is required.

\*2 Recommended resolution (S2232W: Set this resolution)

\*3 Recommended resolution (S2242W/S2432W: Set this resolution)

# 1-4 Functions and Basic Operation

## To adjust the screen and color

● Main menu (Refer to [page 12](#) for operation)

[At analog signal input]

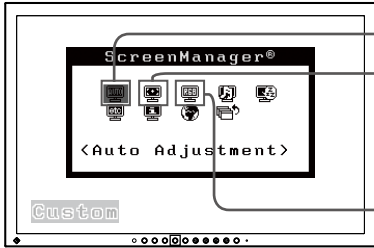

[At digital signal input]

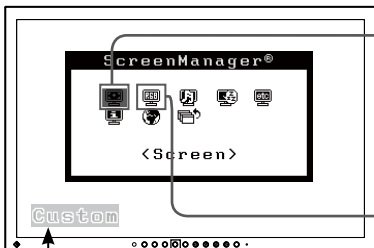

• The Adjustment menu and the FineContrast mode name cannot be displayed at the same time.

(M) FineContrast mode

### Color Adjustment

Page 17

#### Simple Adjustment [FineContrast mode]

This function allows easy selection of a desired mode from five modes according to monitor application.

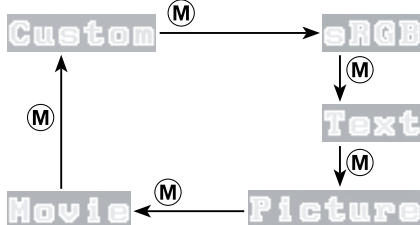

- To adjust the brightness [Brightness]  
Press or to adjust brightness.



- Adjusting Volume [Volume]  
Press or to adjust volume.



- Setting On/Off for the automatic brightness adjustment function [Auto EcoView]  
Press to switch the setting.
- Displaying the level of power saving by EcoView Index  
Press to display the level of power saving mode.



Analog input only

### 1 Screen Adjustment (Automatic Adjustment)

Page 14



- To adjust flickering and position  
[Screen]..... see [page 14](#)
- To adjust color gradation automatically  
[Range] ..... see [page 16](#)



### 2 Screen Adjustment (Advanced Adjustment)

Page 15

[At analog signal input] [At digital signal input]

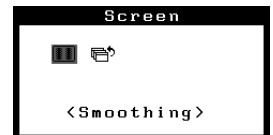
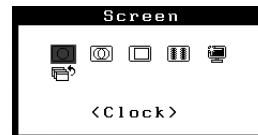

- To eliminate vertical bars [Clock\*] ... see [page 15](#)
- To remove flickering or blurring  
[Phase\*]..... see [page 15](#)
- To correct screen position  
[Position\*] ..... see [page 16](#)
- To modify blurred characters/lines  
[Smoothing] ..... see [page 16](#)
- To set when a noise appears on the screen  
[Signal Filter\*] ..... see [page 32](#)

\* Items marked with \* can be adjusted with analog input.

### Color Adjustment Advanced Adjustment

Page 18



- “Brightness”, “Contrast”, “Temperature”, “Gamma”, “Saturation”, “Hue” and “Gain” can be set for each mode (Custom/sRGB/Text/Picture/Movie).  
Settable functions vary with the FineContrast mode.

#### Resuming the default settings

- To reset color adjustment values  
[Reset] ..... see [page 27](#)

# To make useful settings/adjustments

● Adjustment menu (Refer to [page 12](#) for operation)

## [At analog signal input]

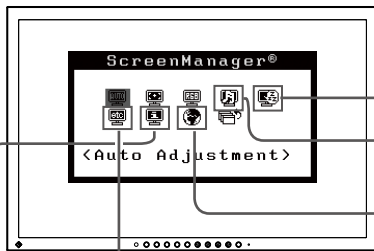

## [At digital signal input]

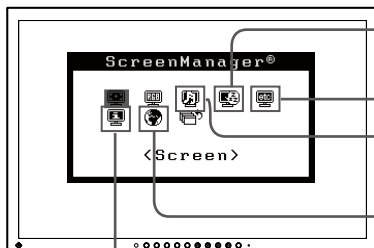

### Information

Page 25

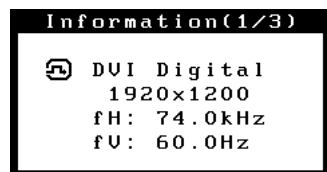

- Displaying Monitor Information [Information]

### Language

Page 26



- Setting Language [Language]

- Locking Buttons ..... see [page 25](#)
- Enabling/Disabling DDC/CI communication [DDC/CI] ..... see [page 26](#)
- Setting EIZO logo display ON/OFF ... see [page 26](#)
- Adjusting the DVI Input Level [DVI Input Level] ..... see [page 29](#)

### Power-save Settings



- Setting On/Off for Power Saving mode [Power Save] ..... see [page 21](#)
- Turning off the monitor automatically [Off Timer] ..... see [page 22](#)
- Displaying the level of power saving by EcoView Index [EcoView Index] ..... see [page 22](#)

### Other Settings



- To change screen size [Screen Size] ..... see [page 23](#)
- To adjust brightness of non-display area [Border Intensity] ..... see [page 23](#)
- To set input signal selection [Input Signal] ..... see [page 29](#)
- To update menu settings [Menu Size/Menu Position/Menu Off Timer/Translucent] ..... see [page 24](#)
- To set the orientation of the Adjustment menu [Orientation] ..... see [page 25](#)
- Setting Power Indicator ON/OFF [Power Indicator] ..... see [page 26](#)
- To reset all adjustments to the factory default settings [Reset] ..... see [page 27](#)

















### Sound Settings





- Adjusting Volume [Volume]..... see [page 20](#)
- Turning off the audio output at Power Saving mode [Power Save]..... see [page 20](#)

## Basic operation of Adjustment menu



### [Displaying Adjustment menu and selecting function]

- (1) Press . The Main menu appears.
- (2) Select a function with  /  /  / , and press . The Sub menu appears.
- (3) Select a function with  /  /  / , and press . The adjustment/setting menu appears.
- (4) Adjust the selected item with  /  /  / , and press . The setting is saved.

### [Exiting Adjustment menu]

- (1) Choose <Return> from the Sub menu and press . The Main menu appears.
- (2) Choose <Exit> from the Main menu and press . The Adjustment menu quits.

#### NOTE

- The Adjustment menu can also be exited by pressing  twice quickly.
- <Exit> or <Return> can also be selected by pressing  twice in the Main menu or Sub menu.

# Chapter 2 Settings and Adjustments

## 2-1 Utility Disk

An “EIZO LCD Utility Disk” (CD-ROM) is supplied with the monitor. The following table shows the disk contents and the overview of the software programs.

### • Disk contents and software overview

The disk includes software programs for adjustment, and User's Manual. Refer to “Readme.txt” or the “read me” file on the disk for software startup procedures or file access procedures.

Item	Overview	OS
A “Readme.txt” or “read me” file		
Screen Adjustment Utility	Monitor pattern display software used when adjusting the image of the analog input signal manually.	Windows 2000/XP/Vista
Screen adjustment pattern files	Used when adjusting the image of the analog signal input manually. If the Screen Adjustment Utility is not applicable to your PC, use this pattern files to adjust the image.	Windows * If your OS is other than Windows, download the pattern files from our site: <a href="http://www.eizo.com">http://www.eizo.com</a>
ScreenManager Pro for LCD  * WindowMovie Checker Software	A software for adjusting the screen using the mouse and keyboard. Connect the monitor to the PC with the supplied USB cable before installation. Regarding the adjustable items, refer to the "Parameter Adjustment Items".  WindowMovie is a function of ScreenManager Pro for LCD. For more information, refer to the User's Manual of ScreenManager Pro for LCD on the disk.	Windows XP/Vista
ScreenManager Pro for LCD (DDC/CI)	A software for adjusting the screen using the mouse and keyboard. It differs from the ScreenManager Pro for LCD in that it does not need the USB cable connection although some functions are not implemented.	Windows Vista
EIZO ScreenSlicer	A software that divides a screen and lays out multiple windows efficiently.	Windows XP/Vista
User's Manual of this monitor (PDF file)		

### • To use ScreenManager Pro for LCD

For the installation and use of ScreenManager Pro for LCD, refer to its User's Manual on the disk.

To adjust the monitor using ScreenManager Pro for LCD, connect a PC to the monitor with the supplied USB cable.

For more information, refer to the “Chapter 3 3-3 Connecting Peripheral USB Devices” (page 30).

#### NOTE

- ScreenManager Pro for LCD and ScreenManager Pro for LCD (DDC/CI) cannot be installed at the same time.

## 2-2 Screen Adjustment

### Digital Input

When digital signals are input, images are displayed correctly based on the preset data of the monitor, but if characters and/or lines appear blurred, go to step 6 “To modify blurred characters/lines [Smoothing]”. When performing more advanced adjustment, see “2-3 Color Adjustment” (page 17) and subsequent pages.

### Analog Input

The monitor screen adjustment is used to suppress flickering of the screen or adjust screen position and screen size correctly according to the PC to be used.





**The auto adjust function works in the following cases:**

- When a signal is input into the monitor for the first time
- When the resolution or Vertical/Horizontal Frequency not displayed before is set

If the screen is not displayed correctly even after performing the auto adjustment, perform the screen adjustments according to the procedures on the following pages to use the monitor comfortably.

#### [Adjustment Procedure]

### 1 Perform the auto adjustment.

- **To adjust flickering, screen position, and screen size automatically [Screen]**
  - (1) Choose <Screen> from the <Auto Adjustment> menu, and press .  
The <Auto Adjustment> menu appears.
  - (2) Choose <Execute> with  or , and press .  
Flickering, screen position, and screen size are corrected by the auto-adjustment function.

**If the screen is not displayed correctly even after adjusting in step 1 above, perform the adjustments according to the procedures on the following pages. When the screen is displayed correctly, go to step 5 “To adjust color gradation automatically [Range]”.**

### 2 Prepare the display pattern for the analog display adjustment.

- For Windows PC  
Load the "EIZO LCD Utility Disk" to your PC, and then start the "Screen Adjustment Utility" from the start menu.  
If it cannot be started, open the screen adjustment pattern files.
- For other than Windows PC  
Download the "Screen adjustment pattern files" from our site: <http://www.eizo.com>

#### Attention

- Wait 30 minutes or more from monitor power on before starting adjustments.
- Auto adjust function does not work for the images under the resolution of 800 × 600 (SVGA).

#### Attention

- This function works correctly when an image is fully displayed over the Windows or Macintosh display area. It does not work properly when an image is displayed only on a part of the screen (command prompt window, for example) or when a black background (wallpaper, etc.) is in use.
- This function does not work correctly with some graphics boards.
- “Auto in Progress” appears on the screen during auto adjustment.

#### NOTE

- For how to open and contents of the screen adjustment pattern files, refer to “Readme.txt”. When using the OS except Windows, refer to the downloaded “read me” file.

### 3 Perform the auto adjustment again with the analog screen adjustment pattern displayed.

- **To adjust flickering, screen position, and screen size automatically [Screen]**

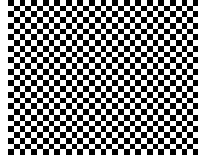

(1) Display Pattern 1 in full screen on the monitor using the “Screen Adjustment Utility” or the screen adjustment pattern files.



(2) Choose <Screen> from the <Auto Adjustment> menu, and press



The <Auto Adjustment> menu appears.

(3) Choose <Execute> with  or , and press .

Flickering, screen position, and screen size are corrected by the auto-adjustment function.

**If the screen is not displayed correctly even after adjusting in step 3 above, perform the adjustments according to the procedures on the following pages. When the screen is displayed correctly, go to step 5 “To adjust color gradation automatically [Range]”.**



### 4 Perform advanced adjustments for the following using the <Screen> menu of the Adjustment menu.

Adjust the clock, phase and position, in this order.

- **To eliminate vertical bars [Clock]**

(1) Choose <Clock> from the <Screen> menu, and press .

The <Clock> menu appears.

(2) Adjust the clock with  or , and press .

The adjustment is completed.

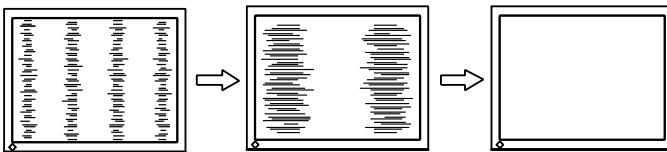



- **To remove flickering or blurring [Phase]**

Adjustable range: 0 to 63

(1) Choose <Phase> from the <Screen> menu, and press .

The <Phase> menu appears.

(2) Adjust the phase with  or , and press .

The adjustment is completed.

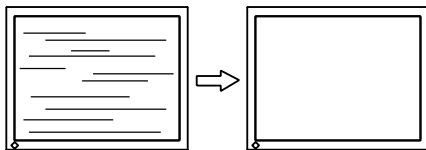

#### NOTE

- Press the control button slowly so as not to miss the adjustment point.
- When blurring, flickering or bars appear on the screen after adjustment, proceed to [Phase] to remove flickering or blurring.







#### Attention

- Flickering or blurring may not be eliminated depending on your PC or graphics board.

#### NOTE

- When vertical bars appear on the screen after adjustment, go back to “To eliminate vertical bars [Clock]”. (Clock → Phase → Position)

- **To correct screen position [Position]**

- (1) Choose <Position> from the <Screen> menu, and press .  
The <Position> menu appears.
- (2) Adjust the position with  /  /  /  to display the image properly in the display area of the monitor, and press .  
The adjustment is completed.

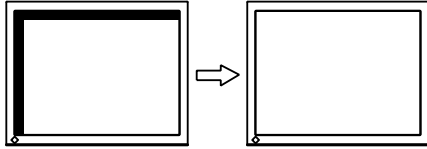





## 5 Adjust the color gradation.

- **To adjust color gradation automatically [Range]**

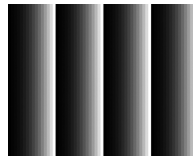
Every color gradation (0 to 255) can be displayed by adjusting the signal output level.

- (1) Display Pattern 2 in full screen on the monitor using the “Screen Adjustment Utility” or the screen adjustment pattern files.







- (2) Choose <Range> from the <Auto Adjustment> menu, and press .
- (3) Choose “Execute” with  or , and press .  
The output range is adjusted automatically.
- (4) Close the Pattern 2. When using the “Screen Adjustment Utility”, close the program.

## 6 Modify blurred characters or lines.

- **To modify blurred characters/lines [Smoothing]**

When a image is displayed with a resolution other than the recommendation, the characters or lines of the displayed image may be blurred.

Adjustable range: 1 to 5

- (1) Choose <Screen> from the Adjustment menu, and press .
  - (2) Choose <Smoothing> from the <Screen> menu, and press .
  - (3) Adjust the characters/lines with  or , and press .
- The adjustment is completed.

### NOTE

- Since the number of pixels and the pixel positions are fixed on the LCD monitor, only one position is provided to display images correctly. The position adjustment is made to shift an image to the correct position.

### Attention

- Smoothing setting may not be required depending on the display resolution. (You cannot choose the smoothing icon.)



## 2-3 Color Adjustment

- **To select the display mode (FineContrast mode)**

FineContrast allows you to select the best display mode easily according to the monitor's application.

FineContrast mode

Mode	Purpose
Custom	Available to change all setting values.
sRGB	Suitable for color matching with sRGB compatible peripherals.
Text	Suitable for displaying texts for word processing or spreadsheets.
Picture	Suitable for displaying images such as photos or picture images.
Movie	Suitable for playing back animated images.

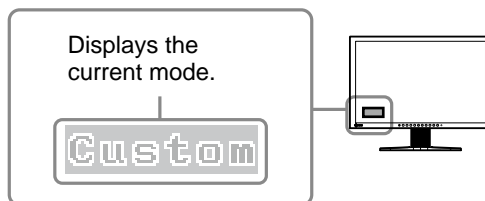

(1) Press **(M)**.

The FineContrast mode name appears at the lower left of the screen.

(2) One of five modes is displayed in turn each time **(M)** is pressed.

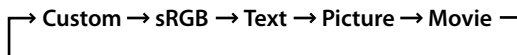

### NOTE

- The Adjustment menu and the FineContrast mode name cannot be displayed at the same time.
- “ScreenManager Pro for LCD” allows you to select the FineContrast mode automatically according to the application used. (Refer to “Chapter 3 Auto FineContrast” on the User’s Manual for “ScreenManager Pro for LCD”.)









## • To perform advanced adjustments

Independent setting and saving of color adjustment are available for each FineContrast mode.

## • Adjustment items in each mode

According to the FineContrast mode selected, the adjustable function differs.





√ : Adjustment available    – : Invalid for adjustment

Icon	Function	FineContrast mode				
		Custom	sRGB	Text	Picture	Movie
	Brightness	√	√	√	√	√
	Contrast	√	–	√	√	√
	Temperature	√	–	√	√	√
	Gamma	√	–	√	–	–
	Saturation	√	–	√	√	√
	Hue	√	–	√	√	√
	Gain	√	–	–	–	–
	Reset	√	√	√	√	√

## • To adjust the brightness [Brightness]

The screen brightness is adjusted by changing the brightness of the backlight (Light source from the LCD back panel).





Adjustable range: 0 to 100%

- Choose <Color> from the Adjustment menu, and press .
- Choose <Brightness> from the <Color> menu, and press .  
The <Brightness> adjustment menu appears.
- Adjust the brightness with  or , and press .  
The adjustment is completed.

## • To adjust the contrast [Contrast]

The luminance of the screen is adjusted by varying the video signal level.

Adjustable range: 0 to 100%

- Choose <Color> from the Adjustment menu, and press .
- Choose <Contrast> from the <Color> menu, and press .  
The <Contrast> adjustment menu appears.
- Adjust the contrast with  or , and press .  
The adjustment is completed.



### Attention

- Wait 30 minutes or more from monitor power on before starting the color adjustment.
- Perform the range adjustment first when adjusting color for analog input signals.  
(Refer to “To adjust color gradation automatically [Range]” on [page 16](#)).
- The same image may be seen in different colors on multiple monitors due to their monitor-specific characteristics. Make fine color adjustment visually when matching colors on multiple monitors.

### NOTE

- The values shown in “%” or “K” are available only as reference.
- Using the “ScreenManager Pro for LCD” allows you to perform the color adjustment by using the mouse and keyboard of your PC. The adjusted status can be registered as a color data and restore the data later. (Refer to “Chapter 4 Color Adjustment” on the User’s Manual for “ScreenManager Pro for LCD”.)

### NOTE

- You can also adjust the brightness by pressing  or  without displaying the adjustment menu.

### NOTE

- In the contrast of 50%, every color gradation is displayed.
- When adjusting the monitor, it is recommended to perform the brightness adjustment which may not lose the gradation characteristics, prior to the contrast adjustment. Perform the contrast adjustment in the following cases.
  - When you feel the image is dark even if the brightness is set to 100%. (Set the contrast to higher than 50%).
  - When you feel the image is bright even if the brightness is set to 0%. (Set the contrast to lower than 50%).





## ● To adjust the color temperature [Temperature]

The color temperature can be adjusted. The color temperature is normally used to express the hue of “White” and/or “Black” by a numerical value. The value is expressed in degrees “K” (Kelvin).

In the same way as the flame temperature, the image on the monitor is displayed reddish if the color temperature is low and is bluish if the color temperature is high. The gain preset values are set for each color temperature setting value.

5000K	The white color image is displayed reddish. The 5000K or 6000K is usually used in the printing industry.
6500K	The white color image is displayed in warm white like paper white. The temperature is suitable to display photographs or video images.
9300K	The white color image is displayed slightly bluish white.





Adjustable range: Off, 4000K-10000K (specified by every 500K unit, including 9300K)

- (1) Choose <Color> from the Adjustment menu, and press .
- (2) Choose <Temperature> from the <Color> menu, and press .  
The <Temperature> adjustment menu appears.
- (3) Adjust the color temperature with  or , and press .  
The adjustment is completed.

## ● To adjust the gamma value [Gamma]

The gamma value can be adjusted. The luminance of the monitor varies depending on the input signal, however, the variation rate is not proportional to the input signal. To keep the balance between the input signal and the luminance of the monitor is called as “Gamma correction”.





Adjustable range: 1.8, 2.0, 2.2

- (1) Choose <Color> from the Adjustment menu, and press .
- (2) Choose <Gamma> from the <Color> menu, and press .  
The <Gamma> adjustment menu appears.
- (3) Adjust the gamma value with  or , and press .  
The adjustment is completed.

## ● To adjust the color saturation [Saturation]

This function allows you to adjust the saturation of the color on the monitor.

Adjustable range: -128 to 127

- (1) Choose <Color> from the Adjustment menu, and press .
- (2) Choose <Saturation> from the <Color> menu, and press .  
The <Saturation> adjustment menu appears.
- (3) Adjust the saturation of the color with  or , and press .  
The adjustment is completed.

### NOTE

- You cannot adjust the value if the icon is not displayed, depending on the FineContrast mode selected. (See “Adjustment items in each mode” on [page 18](#).)
- [Gain] allows you to perform more advanced adjustment (See “To adjust the gain value” on [page 20](#)).
- If you set to [Off], the image is displayed in the preset color of the monitor (Gain: 100% for each RGB).
- When changing the gain value, the color temperature adjusting range is changed to “Off”.

### NOTE

- You cannot adjust the value if the icon is not displayed, depending on the FineContrast mode selected. (See “Adjustment items in each mode” on [page 18](#).)

### Attention

- This function does not enable to display every color gradation.





### NOTE

- You cannot adjust the value if the icon is not displayed, depending on the FineContrast mode selected. (See “Adjustment items in each mode” on [page 18](#).)
- Setting the minimum (-128) turns the image to a monochrome screen.

### ● To adjust the hue [Hue]

This function allows you to adjust the hue. If you set the hue to a high value, the image turns greenish. If low, the image turns purplish.





Adjustable range: -32 to 32

- (1) Choose <Color> from the Adjustment menu, and press .
- (2) Choose <Hue> from the <Color> menu, and press .  
The <Hue> adjustment menu appears.
- (3) Adjust the hue with  or , and press .  
The adjustment is completed.

### ● To adjust the gain value [Gain]

Each luminance of red/green/blue composing the color is called “Gain”. The gain adjustment may change the color tone of the “White” (when the max input signal for each color is obtained)





Adjustable range: 0 to 100%

- (1) Choose <Color> from the Adjustment menu, and press .
- (2) Choose <Gain> from the <Color> menu, and press .  
The <Gain> adjustment menu appears.
- (3) Adjust the respective value of Red, Green or Blue with  or , and press .  
The adjustment is completed.

## 2-4 Adjusting Volume [Volume]





This function allows you to adjust volume up or down.

Adjustable range: 0 to 20

- (1) Choose <Sound> from the Adjustment menu, and press .
- (2) Choose <Volume> from the <Sound> menu, and press .  
The volume adjustment menu appears.
- (3) Adjust the volume with  or , and press .  
The adjustment is completed.

## 2-5 Turning off the audio output at Power Saving mode [Power Save]

This monitor allows you to turn off the audio output from the speakers/headphone at the power saving mode.

- (1) Choose <Sound> from the Adjustment menu, and press .
- (2) Choose <Power Save> from the <Sound> menu, and press .  
The <Power Save> setting menu appears.
- (3) Select “On” or “Off” with  or , and press .  
The setting is completed.

### Attention

- This function does not enable to display every color gradation.

### NOTE

- You cannot adjust the value if the icon is not displayed, depending on the FineContrast mode selected. (See “Adjustment items in each mode” on [page 18.](#))



### Attention

- This function does not enable to display every color gradation.

### NOTE

- You cannot adjust the value if the icon is not displayed, depending on the FineContrast mode selected. (See “Adjustment items in each mode” on [page 18.](#))
- The gain value may change depending on the value of the color temperature.
- When changing the gain value, the color temperature adjusting range is changed to “Off”.

### NOTE

- You can also adjust volume by pressing  or  without displaying the adjustment menu.

## 2-6 Setting On/Off for the automatic brightness adjustment function [Auto EcoView]

The sensor on the front side of the monitor detects the environmental brightness to adjust the screen brightness automatically and comfortably by using the Auto EcoView function.

(1) Press .

The <Auto EcoView> setting menu appears.

(2) The On/Off setting is toggled by pressing .



## 2-7 Setting On/Off for Power Saving mode [Power Save]

This function allows you to set the monitor into the power saving mode according to the PC status.

(1) Choose <PowerManager> from the Adjustment menu, and press .

(2) Choose <Power Save> from the <PowerManager> menu, and press .

The <Power Save> setting menu appears.

(3) Select “On” or “Off” with  or , and press .

The setting is completed.

### ■ Analog input

This monitor complies with the VESA DPMS standard.

#### [Power Saving System]

PC		Monitor	Power Indicator
Operating		Operating	Blue
Power saving	STAND-BY SUSPENDED OFF	Power saving	Orange

### ■ Digital input

This monitor complies with the DVI DMPM standard.

#### [Power Saving System]

The monitor enters the power saving mode in five seconds in connection with the PC setting.

PC	Monitor	Power Indicator
Operating	Operating	Blue
Power saving	Power saving	Orange

#### NOTE

- Be careful not to block the sensor on the lower side of the monitor when using the Auto EcoView function.







#### Attention

- Turning off the main power switch or unplugging the power cord completely shuts off power supply to the monitor.
- Devices connected to the USB port (upstream and downstream) work when the monitor is in power saving mode or when the power button of the monitor is Off. Therefore, power consumption of the monitor varies with connected devices even in the power saving mode.
- Power consumption varies even when the stereo mini jack cable is connected.

## 2-8 Turning off the monitor automatically [Off Timer]

This function allows you to switch the setting to turn off the monitor automatically after a specified time has passed at the power saving mode.

Adjustable range: Disable, Enable (0, 1, 2, 3, 5, 10, 15, 20, 25, 30, 45 min, 1-5h)

- (1) Choose <PowerManager> from the Adjustment menu, and press .
- (2) Choose <Off Timer> from the <PowerManager> menu, and press .  
The <Off Timer> setting menu appears.
- (3) Select “Enable” or “Disable” with  or .  
When selecting “Enable”, set a monitor Off time with  or .
- (4) Press .  
The setting is completed.

## 2-9 Displaying the level of power saving by EcoView Index

This function allows you to display the power saving level by green indicator. The power saving ratio comes to high as the indicator level meter lights towards right.

- (1) Press .  
The EcoView Index menu appears.

### NOTE

- EcoView Index appears when adjusting brightness or switching the FineContrast mode, etc. You can switch the on/off setting of displaying EcoView Index in <EcoView Index> menu from the <PowerManager> menu.

## 2-10 Screen Size Selection





### • To change screen size [Screen Size]

The image with the resolution other than the recommended resolution is displayed in full screen automatically. You can change the screen size by using <Screen Size> from <Others> menu.

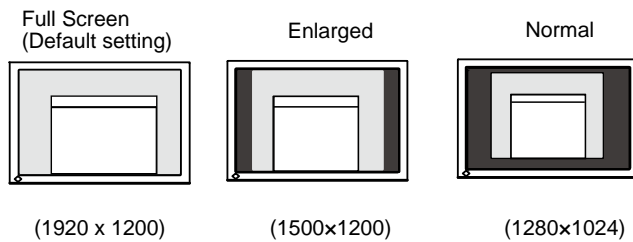
Menu	Function
Full Screen (default setting)	Displays an image in full screen. Images are distorted in some cases because the vertical rate is not equal to the horizontal rate.
Enlarged	Displays an image in full screen. In some cases, a blank horizontal or vertical border appears to equalize the vertical rate and the horizontal rate.
Normal	Displays images with the specified resolution.

Example: Image size 1280 x 1024 in case of S2432W





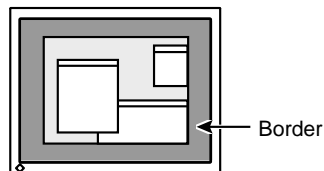

- (1) Choose <Others> from the Adjustment menu, and press .
- (2) Choose <Screen Size> from the <Others> menu, and press .  
The screen size setting window appears.
- (3) Select “Full Screen,” “Enlarged,” or “Normal” with  or , and press .  
The screen size setting is completed.

### • To adjust brightness of non-display area [Border Intensity]

A border (black area with no image) around the image appears in the “Normal” or “Enlarged” mode.









- (1) Choose <Others> from the Adjustment menu, and press .
- (2) Choose <Border Intensity> from the <Others> menu, and press .  
The <Border Intensity> menu appears.
- (3) Adjust border intensity with  or , and press .  
The border intensity adjustment is completed.

## 2-11 Setting Adjustment Menu Display

- To update menu settings [Menu Size/Menu Position/Menu Off Timer/Translucent]









### Menu Size

Change the Adjustment menu size using the following procedure.

- (1) Choose <Others> from the Adjustment menu, and press .
- (2) Choose <Menu Settings> from the <Others> menu, and press .
- (3) Choose <Menu Size> from the <Menu Settings> menu, and press .  
The <Menu Size> menu appears.
- (4) Select “Normal” or “Enlarged” with  or , and press .  
The setting is completed.

### Menu Position









Adjust the menu position using the following procedure.

- (1) Choose <Others> from the Adjustment menu, and press .
- (2) Choose <Menu Settings> from the <Others> menu, and press .
- (3) Choose <Menu Position> from the <Menu Settings> menu, and press .  
The <Menu Position> menu appears.
- (4) Select a menu position with  /  /  / , and press .  
The setting is completed.

### Menu Off Timer







Set the menu display time using the following procedure.

Adjustment range: Disable, Enable (15, 30, 45, 60s)

- (1) Choose <Others> from the Adjustment menu, and press .
- (2) Choose <Menu Settings> from the <Others> menu, and press .
- (3) Choose <Menu Off Timer> from the <Menu Settings> menu, and press .  
The <Menu Off Timer> menu appears.
- (4) Select “Enable” or “Disable” with  or .  
When selecting “Enable”, choose a time for displaying menu with  or .
- (5) Press .  
The setting is completed.

### Translucent

Set the transparency for menu display using the following procedure.

- (1) Choose <Others> from the Adjustment menu, and press .
- (2) Choose <Menu Settings> from the <Others> menu, and press .
- (3) Choose <Translucent> from the <Menu Settings> menu, and press .  
The <Translucent> menu appears.
- (4) Adjust the transparency for menu display with  or , and press .  
The setting is completed.

#### NOTE





- The display time of the FineContrast mode and EcoView Index remains unchanged.



## 2-12 Setting Orientation



### • To set the orientation of the Adjustment menu [Orientation]

This function allows you to change the orientation of the Adjustment menu when using the monitor screen in vertical display position.

- (1) Choose <Others> from the Adjustment menu, and press .
- (2) Choose <Orientation> from the Others menu, and press .  
The <Orientation> menu appears.
- (3) Select "Landscape" or "Portrait" with  or , and press .  
The setting is completed.
- (4) When selecting "Portrait", turn the monitor screen 90° in clockwise direction.

## 2-13 Locking Buttons

This function allows you to lock  to prevent changing the adjusted/set status.

- (1) Press  to turn off the monitor.
- (2) Press  holding  down to turn on the monitor.  
The Lock/Unlock setting is toggled by performing the operation in step 2.



## 2-14 Displaying Monitor Information [Information]

This function allows you to display the input signal status, current resolution and model name.

Information 1/3 : Input signal status (D-Sub/DVI Digital),  
resolution and H/V frequency

Information 2/3 : Enable/Disable setting for DDC/CI

Information 3/3 : Model name, serial number and usage time

- (1) Choose <Information> from the Adjustment menu, and press .  
The <Information> menu appears.
- (2) Then, press  to check settings, etc.

### Attention

- Be sure that the cables are correctly connected.

### NOTE



- For using the monitor with "Portrait" position, the graphics board supporting portrait display is required. When placing the monitor in a "Portrait" position, settings of your graphics board need to be changed. Refer to the manual of the graphics board for details.

### NOTE

- The usage time is not always "0" when you purchase the monitor due to factory inspection.

## 2-15 Enabling/Disabling DDC/CI communication



This function allows you to enable/disable the DDC/CI communication.

- (1) Press  to turn off the monitor.
- (2) Press  holding  down to turn on the monitor.



The Enable/Disable setting is toggled by performing the operation in step 2.

## 2-16 Setting Power Indicator ON/OFF [Power Indicator]

This function allows you to set the power indicator (blue) ON/OFF in the monitor ON condition.

- (1) Choose <Others> from the Adjustment menu, and press .
- (2) Choose <Power Indicator> from the <Others> menu, and press .

The <Power Indicator> menu appears.

- (3) Select “Enable” or “Disable” with  or , and press .

The setting is completed.

## 2-17 Setting Language [Language]

This function allows you to select a language for the adjustment menu or displaying message.

### Selectable languages

English/German/French/Spanish/Italian/Swedish/Simplified Chinese/  
Traditional Chinese/Japanese

- (1) Choose <Language> menu from the Adjustment menu, and press .



The <Language> menu appears.

- (2) Choose a language with  /  /  / , and press .

The setting is completed.

## 2-18 Setting EIZO logo display ON/OFF

The EIZO logo appears on the display when turning on the monitor. This function allows you to display, or not, the EIZO logo.

- (1) Press  to turn off the monitor.
- (2) Press  holding  down to turn on the monitor.

The EIZO logo display setting is toggled by performing the operation in step 2.

### NOTE

- You can check the DDC/CI setting in the <Information> menu.

## 2-19 Resuming the Default Setting [Reset]

There are two types of Reset. One is to reset the color adjustment only to the default settings, and the other is to reset all the settings to the default settings.



### • To reset color adjustment values

Only the adjustment values in the current FineContrast mode will revert to the default settings (factory settings).

(1) Choose <Color> from the Adjustment menu, and press .

(2) Choose <Reset> from the <Color> menu and press .

The <Reset> menu appears.

(3) Select <Reset> with  or , and press .

The color adjustment values revert to the default settings.



### • To reset all adjustments to the factory default settings

Reset all adjustments to the factory default settings.

(1) Choose <Others> from the Adjustment menu, and press .

(2) Choose <Reset> from the <Others> menu, and press .

The <Reset> menu appears.

(3) Select <Reset> with  or , and press .

All setting values revert to the default settings.

#### Attention

- After resetting, you cannot undo the operation.

#### NOTE

- For main default settings, refer to “Main default settings (factory settings)” on [page 40](#).

# Chapter 3 Connecting Cables

## 3-1 Connecting Two PCs to the Monitor

Two PCs can be connected to the monitor through the DVI-D and the D-Sub mini 15 pin connector on the back of the monitor.

### Connection examples

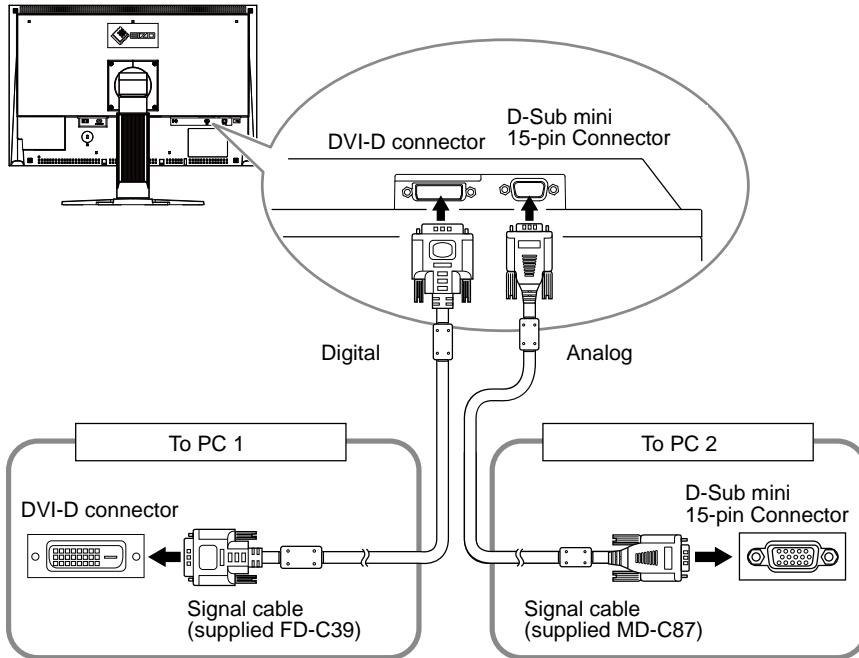

- **To switch the input signal**

The input signal switches each time **(S)** is pressed.

When the signal is switched, the active input port name appears at the top right corner of the screen.

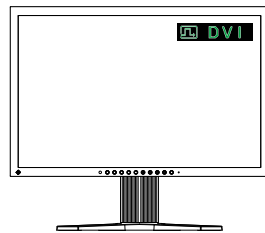

- **To set input signal selection [Input Signal]**

The monitor recognizes the connector through which PC signals are input. When either PC is turned off or enters the power-saving mode, the monitor automatically displays signals of another PC.

Priority setting	Function
Auto	When either PC is turned off or enters the power-saving mode, the monitor automatically displays signals of another PC.
Manual	The monitor detects only the PC's signals currently displaying automatically. Select an active input signal with <b>(S)</b> .

**[Input signal setting]**

- (1) Choose <Others> from the Adjustment menu, and press **(M)**.
- (2) Choose <Input Signal> from the <Others> menu, and press **(M)**.  
The <Input Signal> menu appears.
- (3) Select "Auto" or "Manual" with **(▲)** or **(▼)**, and press **(M)**.  
The setting is completed.

### 3-2 Adjusting the DVI Input Level [DVI Input Level]

This function allows you to adjust the DVI signal input level when using a DVI long cable.

Adjustment range: Auto, Manual (1 to 8)

- (1) Press **(P)** to turn off the monitor.
- (2) Press **(P)** holding **(H)** down to turn on the monitor.  
The <DVI Input Level> adjustment menu appears.
- (3) Select "Auto" or "Manual" with **(▲)** or **(▼)**.  
When selecting "Manual", adjust the input level with **(◀)** or **(▶)** to display correctly.
- (4) Press **(M)**.  
The adjustment is completed.

**NOTE**

- When "Auto" is selected for <Input Signal>, the monitor's power-saving function works only when the two PCs are in the power-saving mode.

**Attention**

- Select "Manual" only if a noise appears on the screen when using a DVI long cable.

### 3-3 Connecting Peripheral USB Devices

This monitor has a hub compatible with USB. Connected to a PC compatible with USB or another USB hub, this monitor functions as a USB hub allowing connection to peripheral USB devices.

- **Required System Environment**

- (1) A PC equipped with a USB port or another USB hub connected to a USB compatible PC
- (2) Windows 2000/XP/Vista or Mac OS 9.2.2 and Mac OS X 10.2 or later
- (3) EIZO USB cable (MD-C93)

- **Connection Procedure (Setup of USB Function)**

- (1) Connect the monitor first to a PC using the signal cable, and run the PC.
- (2) Connect the supplied USB cable between the downstream USB port of a USB compatible PC (or another USB hub) and the monitor's upstream USB port.
- (3) Connect the peripheral USB device to the USB port (downstream) of the monitor.

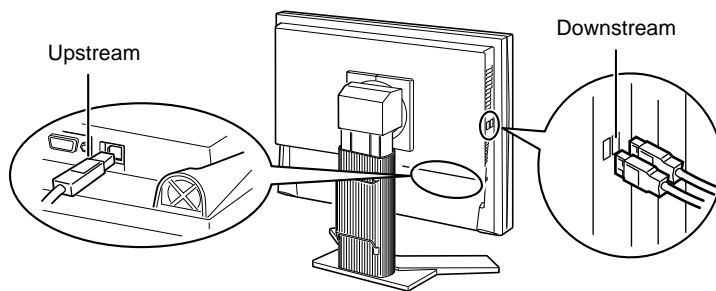

The USB hub function is set up automatically upon connection of the USB cable.





#### Attention



- This monitor may not work depending on PC, OS or peripheral devices to be used. For USB compatibility of peripheral devices, contact their manufactures.
- Devices connected to the USB port (upstream and downstream) work when the monitor is in power saving mode or when the power button of the monitor is Off. Therefore, power consumption of the monitor varies with connected devices even in the power saving mode.
- When the main power switch is Off, device connected to the USB port will not operate.

# Chapter 4 Troubleshooting

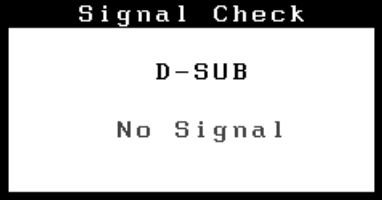
If a problem still remains after applying the suggested remedies, contact your local dealer.

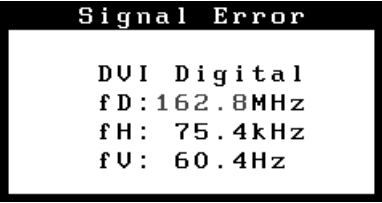
- No-picture problems → See No.1 - No.2.
- Imaging problems (digital input) → See No.3 - No.8.
- Imaging problems (analog input) → See No.3 - No.12.
- Other problems → See No.13 - No.16.
- USB problems → See No.17.

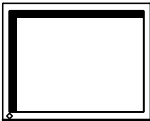
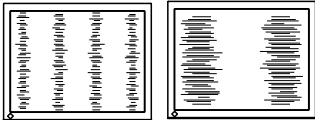
Problems	Possible cause and remedy
<p><b>1. No picture</b></p> <ul style="list-style-type: none"> <li>• Power indicator does not light.</li> </ul>	<ul style="list-style-type: none"> <li>• Check whether the power cord is connected correctly. If the problem persists, turn off the main power, and then turn it on again a few minutes later.</li> <li>• Turn the main power switch on.</li> <li>• Press .</li> </ul>
<ul style="list-style-type: none"> <li>• Power indicator lights blue.</li> </ul>	<ul style="list-style-type: none"> <li>• Set each adjusting value in [Brightness], [Contrast] and [Gain] to higher level. (see <a href="#">page 18, 20</a>)</li> <li>• When using the long DVI cable, adjust the DVI input level using [DVI Input Level]. (see <a href="#">page 29</a>)</li> </ul>
<ul style="list-style-type: none"> <li>• Power indicator lights orange.</li> </ul>	<ul style="list-style-type: none"> <li>• Switch the input signal with .</li> <li>• Operate the mouse or keyboard.</li> <li>• Check whether the PC is turned on.</li> </ul>
<p><b>2. The message below appears.</b></p> <ul style="list-style-type: none"> <li>• This message appears when no signal is input.</li> </ul> 	<p>This message appears when the signal is not input correctly even when the monitor functions properly.</p> <ul style="list-style-type: none"> <li>• The message shown left may appear, because some PCs do not output the signal soon after power-on.</li> <li>• Check whether the PC is turned on.</li> <li>• Check whether the signal cable is connected properly.</li> <li>• Switch the input signal with .</li> <li>• When using the long DVI cable, adjust the DVI input level using [DVI Input Level]. (see <a href="#">page 29</a>)</li> </ul>
<ul style="list-style-type: none"> <li>• The message shows that the input signal is out of the specified frequency range. (Such signal frequency is displayed in red.) Example:</li> </ul> 	<ul style="list-style-type: none"> <li>• Check whether the signal setting of your PC matches the resolution and the vertical frequency settings for the monitor. (see <a href="#">page 9</a>)</li> <li>• Reboot the PC.</li> <li>• Select an appropriate display mode using the graphics board's utility. Refer to the manual of the graphics board for details. <ul style="list-style-type: none"> <li>fD : Dot Clock (Displayed only when the digital signal inputs)</li> <li>fH : Horizontal Frequency</li> <li>fV : Vertical Frequency</li> </ul> </li> </ul>
<p><b>3. The screen is too bright or too dark.</b></p>	<ul style="list-style-type: none"> <li>• Adjust using [Brightness] or [Contrast]. (The LCD monitor backlight has a fixed life span. When the screen becomes dark or begins to flicker, contact your local dealer.) (see <a href="#">page 18</a>)</li> <li>• Turn on the Auto EcoView function. (see <a href="#">page 21</a>) The monitor detects the environmental brightness to adjust the screen brightness automatically.</li> </ul>
<p><b>4. Characters are blurred.</b></p>	<ul style="list-style-type: none"> <li>• Check whether the signal setting of your PC matches the resolution and the vertical frequency settings for the monitor. (see <a href="#">page 9</a>)</li> <li>• Adjust using [Smoothing]. (see <a href="#">page 16</a>)</li> </ul>

Problems	Possible cause and remedy
<p>5. Afterimages appear.</p>	<ul style="list-style-type: none"> <li>• Use a screen saver or off timer function for a long-time image display.</li> <li>• Afterimages are particular to LCD monitors. Avoid displaying the same image for a long time.</li> </ul>
<p>6. Green/red/blue/white dots or defective dots remain on the screen.</p>	<ul style="list-style-type: none"> <li>• This is due to LCD panel characteristics and is not a failure.</li> </ul>
<p>7. Interference patterns or pressure marks remain on the screen.</p>	<ul style="list-style-type: none"> <li>• Leave the monitor with a white or black screen. The symptom may disappear.</li> </ul>
<p>8. Noise appears on the screen.</p>	<ul style="list-style-type: none"> <li>• When entering the signals of analog input, change the setting to "On" in &lt;Signal Filter&gt; from the &lt;Screen&gt; menu.</li> <li>• When entering the signals of HDCP system, the normal images may not be displayed immediately.</li> <li>• When using the long DVI cable, adjust the DVI input level using [DVI Input Level]. (see <a href="#">page 29</a>)</li> </ul>
<p>9. Display position is incorrect.</p> 	<ul style="list-style-type: none"> <li>• Adjust image position so that it is displayed properly within the display area using [Position]. (see <a href="#">page 16</a>)</li> <li>• If the problem persists, use the graphics board's utility if available to change the display position.</li> </ul>
<p>10. Vertical bars appear on the screen or a part of the image is flickering.</p> 	<ul style="list-style-type: none"> <li>• Adjust using [Clock]. (see <a href="#">page 15</a>)</li> </ul>
<p>11. Whole screen is flickering or blurring.</p> 	<ul style="list-style-type: none"> <li>• Adjust using [Phase]. (see <a href="#">page 15</a>)</li> </ul>
<p>12. Upper part of the screen is distorted as shown below.</p> 	<ul style="list-style-type: none"> <li>• This is caused when both composite sync (X-OR) signal and separate vertical sync signal are input simultaneously. Select either composite signal or separate signal.</li> </ul>
<p>13. The &lt;Smoothing&gt; icon on the Adjustment menu &lt;Screen&gt; cannot be selected.</p>	<ul style="list-style-type: none"> <li>• Smoothing setting may not be required depending on the display resolution. (You cannot choose the smoothing icon.)</li> <li>• &lt;Smoothing&gt; is disabled when the screen is displayed in the following resolutions. <ul style="list-style-type: none"> <li>• 1680 × 1050 (S2232W)</li> <li>• 1920 × 1200 (S2242W/S2432W)</li> <li>• Select [Enlarged] during &lt;Screen Size&gt; in the resolution of 1600 × 1200 (S2242W/S2432W)</li> <li>• Select [Normal] during &lt;Screen Size&gt;.</li> </ul> </li> </ul>
<p>14. The adjustment menu does not appear.</p>	<ul style="list-style-type: none"> <li>• Check whether the operation lock function works. (see <a href="#">page 25</a>)</li> </ul>
<p>15. The auto adjust function does not work correctly.</p>	<ul style="list-style-type: none"> <li>• This function does not work when digital signal is input.</li> <li>• This function does not work correctly with some graphics boards.</li> </ul>
<p>16. No audio output.</p>	<ul style="list-style-type: none"> <li>• Check whether the mini jack cable is correctly connected.</li> <li>• Check whether volume is set to 0.</li> <li>• Check the setting of the PC and the audio playback software.</li> </ul>



Problems	Possible cause and remedy
<p><b>17. The monitor connected with the USB cable is not detected. / USB devices connected to the monitor does not work.</b></p>	<ul style="list-style-type: none"> <li>• Check whether the USB cable is connected correctly. (see <a href="#">page 30</a>)</li> <li>• Change the USB port to another one. If the PC or peripheral devices works correctly by changing the USB port, contact your local dealer. (Refer to the manual of the PC for details.)</li> <li>• Reboot the PC.</li> <li>• If the peripheral devices work correctly when the PC and peripheral devices are connected directly, please contact your local dealer.</li> <li>• Check whether the PC and OS are USB compliant. (For USB compliance of the respective devices, consult their manufacturers.)</li> <li>• Check the PC's BIOS setting for USB when using Windows. (Refer to the manual of the PC for details.)</li> </ul>

# Chapter 5 Reference

## 5-1 Attaching an Arm

The stand can be removed and replaced with an arm (or another stand) to be attached to the monitor. Use an arm or stand of EIZO option.

**1 Lay the LCD monitor on a soft cloth spread over on a stable surface with the panel surface facing down.**

**2 Remove the stand. (Prepare a screwdriver.)**

Unscrew the four screws securing the unit and the stand with the screwdriver.

**3 Attach the monitor to the arm or stand.**

Secure the monitor to the arm or stand using the screws specified in the user's manual of the arm or stand.

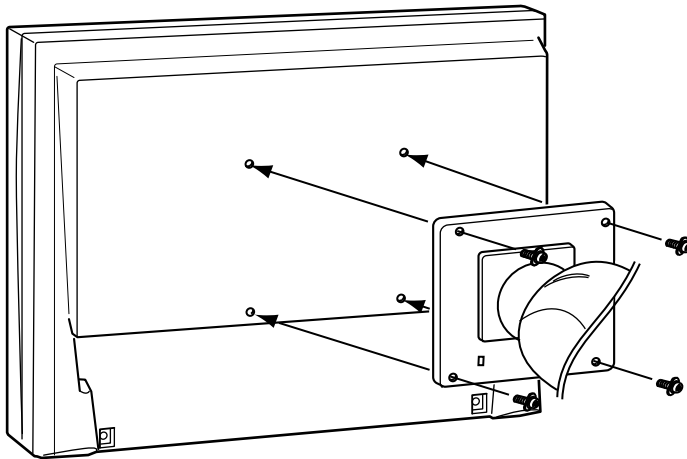

### Attention

- When attaching an arm or stand, follow the instructions of their user's manual.
- When using another manufacturer's arm or stand, confirm the following in advance and select one conforming to the VESA standard.
  - Clearance between the screw holes: 100 mm × 100 mm
  - Thickness of plate: 2.6 mm
  - Strong enough to support weight of the monitor unit (except the stand) and attachments such as cables.Use the screws as described below.
  - Tilt stand  
EZ-UP stand  
Free mount type:  
The screws supplied with this monitor (M4 × 12mm)
  - Height adjustable stand:  
The screws fixing the stand to the monitor
- When using an arm or stand, attach it to meet the following tilt angles of the monitor.
  - Up 45 degrees, down 45 degrees (horizontal display, and vertical display rotated 90 degrees clockwise)
- Connect the cables after attaching an arm.
- If you need to remove the EZ-UP stand, turn the panel on the monitor to the left and right a little to appear the four screws positioned under the stand. Then unscrew the four screws.

## 5-2 Folding the EZ-UP stand

Perform the following procedures to fold the stand when re-packing a monitor with an EZ-UP stand.

**1** Remove the cable holder.

**2** Lower the monitor screen position until the hinge of the stand touches the stand base, and attach the lock metal fitting.

Adjust the monitor angle so as the monitor screen not to touch the stand base.

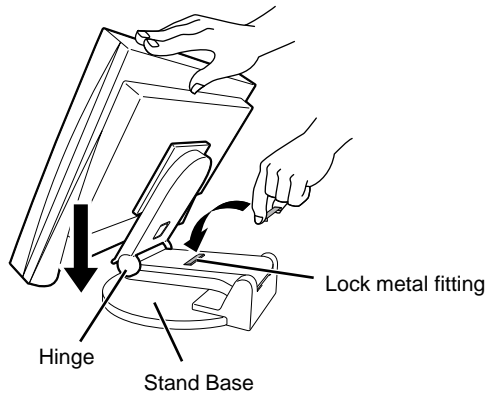

**3** Fall the monitor screen backward with keeping slide-up the "Unlock" knob.

When maximally tilting (25°) the monitor screen backward, the "Unlock" knob may be hard to be slid-up. Then, slightly tilt up the monitor to vertical direction and slide-up the "Unlock" knob.

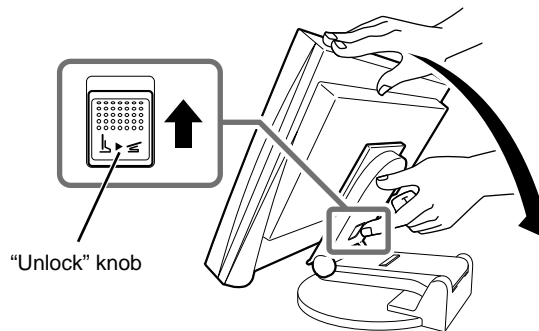

## 5-3 Specifications

### S2232W

LCD Panel		22.0-inch (560 mm) TFT color LCD with anti-glare Viewing angle: Horizontal 178°, Vertical 178° (CR:10 or more)
Dot Pitch		0.282 mm
Horizontal Scan Frequency		Analog: 31-82 kHz Digital: 31-65 kHz
Vertical Scan Frequency		Analog: 55-76 Hz (Non-interlace) (1680 × 1050: 55-61 Hz) Digital: 59-61 Hz (Non-interlace) (VGA TEXT: 69-71 Hz)
Resolution		1680 dots × 1050 lines
Max. Dot Clock		Analog: 150 MHz Digital: 120 MHz
Max. Display Color		Approx. 16.77 million colors: Applicable to 8 bit (1064.33 million colors/10bit LUT)
Display Area (H × V)		473.8 mm × 296.1 mm
Power Supply		100-120 VAC ±10%, 50/60Hz 0.85A 200-240 VAC ±10%, 50/60Hz 0.43A
Power Consumption	Screen Display On	90W or less (with USB load, Speaker working) 80W or less (without USB load, Speaker not working)
	Power saving mode	1.5W or less (for D-Sub single signal input, without USB load, when stereo mini jack cable is not connected, [Input Signal] : "Manual")
	Power button Off	1W or less (without USB load, when stereo mini jack cable is not connected)
	Main Power switch Off	0W
Input Signal Connector		D-Sub mini 15-pin, DVI-D connector (Applicable to HDCP)
Analog Input Signal (Sync)		Separate, TTL, positive/ negative Composite, TTL, positive/ negative
Analog Input Signal (Video)		Analog, Positive (0.7Vp-p/75Ω)
Digital Signal Transmission System		TMDS (Single Link)
Video Signal Memory		Analog signal: 45 (preset: 16) Digital signal: 10
Audio Output		Speaker output: 0.5W + 0.5W (8Ω, THD: 3% or less) Headphone output: 2mW + 2mW
Line input		Input impedance : 48 kΩ (typ.) Input level :1.0 Vrms (Max.)
Plug & Play		VESA DDC 2B / EDID structure 1.3
Dimensions (Width) × (Height) × (Depth)	Main unit (including Height adjustable stand)	511 mm (20.1 inch) × 439 - 521 mm (17.3 - 20.5 inch) × 208.5 mm (8.2 inch)
	Main unit (including Tilt stand)	511 mm (20.1 inch) × 415 mm (16.3 inch) × 205 mm (8.1 inch)
	Main unit (including EZ- UP stand)	511 mm (20.1 inch) × 351.5 - 516.5 mm (13.8 - 20.3 inch) × 279.9 mm - 307.5 mm (11.0 - 12.1 inch)
	Main unit (without stand)	511 mm (20.1 inch) × 333 mm (13.1 inch) × 85 mm (3.35 inch)

Mass	Main unit (including Height adjustable stand)	Approx. 9.6 kg (21.2 lbs.)
	Main unit (including Tilt stand)	Approx. 7.6 kg (16.8 lbs.)
	Main unit (including EZ-UP stand)	Approx. 11.4 kg (25.1 lbs.)
	Main unit (without stand)	Approx. 6.6 kg (14.6 lbs.)
Movable range	Height adjustable stand	Tilt: 40° Up, 0° Down Swivel: 35° Right, 35° Left Adjustable height: 82 mm (3.2 inch) Rotation: 90° (clockwise)
	Tilt stand	Tilt: 30° Up, -5° Down
	EZ-UP stand	Tilt: 25° Up, 0° Down Swivel: 172° Right, 172° Left Adjustable height: 165 mm (6.5 inch) Rotation: 90° (clockwise)
Environmental Conditions	Temperature	Operating temperature: 5 °C - 35 °C (41 °F - 95 °F) Storage temperature: -20 °C - 60 °C (-4 °F - 140 °F)
	Humidity	Operating humidity: 30% - 80% R.H. (no condensation) Storage humidity: 30% - 80% R.H. (no condensation)
	Pressure	Operating: 700 to 1,060 hPa Storage: 200 to 1,060 hPa
USB	Standard	USB Specification Revision 2.0
	Port	Upstream port × 1, Downstream port × 2
	Supply current	Downstream: Max. 500mA/1 port

## S2242W

LCD Panel	22.0-inch (560 mm) TFT color LCD with anti-glare Viewing angle: Horizontal 178°, Vertical 178° (CR:10 or more)	
Dot Pitch	0.247 mm	
Horizontal Scan Frequency	Analog: 31-94 kHz Digital: 31-76 kHz	
Vertical Scan Frequency	Analog: 55-76 Hz (Non-interlace) (1920 × 1200: 55-61 Hz) Digital: 59-61 Hz (Non-interlace) (VGA TEXT: 69-71 Hz)	
Resolution	1920 dots × 1200 lines	
Max. Dot Clock	Analog: 202.5 MHz Digital: 162 MHz	
Max. Display Color	Approx. 16.77 million colors: Applicable to 8 bit (1064.33 million colors/10bit LUT)	
Display Area (H × V)	473.8 mm × 296.1 mm	
Power Supply	100-120 VAC ±10%, 50/60Hz 0.85A 200-240 VAC ±10%, 50/60Hz 0.43A	
Power Consumption	Screen Display On	90W or less (with USB load, Speaker working) 80W or less (without USB load, Speaker not working)
	Power saving mode	1.5W or less (for D-Sub single signal input, without USB load, when stereo mini jack cable is not connected, [Input Signal] : "Manual")
	Power button Off	1W or less (without USB load, when stereo mini jack cable is not connected)
	Main Power switch Off	0W
Input Signal Connector	D-Sub mini 15-pin, DVI-D connector (Applicable to HDCP)	

Analog Input Signal (Sync)		Separate, TTL, positive/ negative Composite, TTL, positive/ negative
Analog Input Signal (Video)		Analog, Positive (0.7Vp-p/75Ω)
Digital Signal Transmission System		TMDS (Single Link)
Video Signal Memory		Analog signal: 45 (preset: 16) Digital signal: 10
Audio Output		Speaker output: 0.5W + 0.5W (8Ω, THD: 3% or less) Headphone output: 2mW + 2mW
Line input		Input impedance : 48 kΩ (typ.) Input level :1.0 Vrms (Max.)
Plug & Play		VESA DDC 2B / EDID structure 1.3
Dimensions (Width) × (Height) × (Depth)	Main unit (including Height adjustable stand)	511 mm (20.1 inch) × 439 - 521 mm (17.3 - 20.5 inch) × 208.5 mm (8.2 inch)
	Main unit (including Tilt stand)	511 mm (20.1 inch) × 415 mm (16.3 inch) × 205 mm (8.1 inch)
	Main unit (including EZ- UP stand)	511 mm (20.1 inch) × 351.5 - 516.5 mm (13.8 - 20.3 inch) × 279.9 mm - 307.5 mm (11.0 - 12.1 inch)
	Main unit (without stand)	511 mm (20.1 inch) × 333 mm (13.1 inch) × 85 mm (3.35 inch)
Mass	Main unit (including Height adjustable stand)	Approx. 9.6 kg (21.2 lbs.)
	Main unit (including Tilt stand)	Approx. 7.6 kg (16.8 lbs.)
	Main unit (including EZ- UP stand)	Approx. 11.4 kg (25.1 lbs.)
	Main unit (without stand)	Approx. 6.6 kg (14.6 lbs.)
Movable range	Height adjustable stand	Tilt: 40° Up, 0° Down Swivel: 35° Right, 35° Left Adjustable height: 82 mm (3.2 inch) Rotation: 90° (clockwise)
	Tilt stand	Tilt: 30° Up, -5° Down
	EZ-UP stand	Tilt: 25° Up, 0° Down Swivel: 172° Right, 172° Left Adjustable height: 165 mm (6.5 inch) Rotation: 90° (clockwise)
Environmental Conditions	Temperature	Operating temperature: 5 °C - 35 °C (41 °F - 95 °F) Storage temperature: -20 °C - 60 °C (-4 °F - 140 °F)
	Humidity	Operating humidity: 30% - 80% R.H. (no condensation) Storage humidity: 30% - 80% R.H. (no condensation)
	Pressure	Operating: 700 to 1,060 hPa Storage: 200 to 1,060 hPa
USB	Standard	USB Specification Revision 2.0
	Port	Upstream port × 1, Downstream port × 2
	Supply current	Downstream: Max. 500mA/1 port

### S2432W

LCD Panel	24.1-inch (610 mm) TFT color LCD with anti-glare Viewing angle: Horizontal 178°, Vertical 178° (CR:10 or more)
Dot Pitch	0.270 mm
Horizontal Scan Frequency	Analog: 31-94 kHz Digital: 31-76 kHz

Vertical Scan Frequency		Analog: 55-76 Hz (Non-interlace) (1920 × 1200: 55-61 Hz) Digital: 59-61 Hz (Non-interlace) (VGA TEXT: 69-71 Hz)
Resolution		1920 dots × 1200 lines
Max. Dot Clock		Analog: 202.5 MHz Digital: 162 MHz
Max. Display Color		Approx. 16.77 million colors: Applicable to 8 bit (1064.33 million colors/10bit LUT)
Display Area (H × V)		518.4 mm × 324.0 mm
Power Supply		100-120 VAC ±10%, 50/60Hz 0.95A 200-240 VAC ±10%, 50/60Hz 0.45A
Power Consumption	Screen Display On	95W or less (with USB load, Speaker working) 90W or less (without USB load, Speaker not working)
	Power saving mode	1.5W or less (for D-Sub single signal input, without USB load, when stereo mini jack cable is not connected, [Input Signal] : "Manual")
	Power button Off	1W or less (without USB load, when stereo mini jack cable is not connected)
	Main Power switch Off	0W
Input Signal Connector		D-Sub mini 15-pin, DVI-D connector (Applicable to HDCP)
Analog Input Signal (Sync)		Separate, TTL, positive/ negative Composite, TTL, positive/ negative
Analog Input Signal (Video)		Analog, Positive (0.7Vp-p/75Ω)
Digital Signal Transmission System		TMDS (Single Link)
Video Signal Memory		Analog signal: 45 (preset: 22) Digital signal: 10
Audio Output		Speaker output: 0.5W + 0.5W (8Ω, THD: 3% or less) Headphone output: 2mW + 2mW
Line input		Input impedance : 48 kΩ (typ.) Input level :1.0 Vrms (Max.)
Plug & Play		VESA DDC 2B / EDID structure 1.3
Dimensions (Width) × (Height) × (Depth)	Main unit (including Height adjustable stand)	566 mm (22.3 inch) × 456 - 538 mm (18.0 - 21.2 inch) × 208.5 mm (8.2 inch)
	Main unit (including EZ-UP stand)	566 mm (22.3 inch) × 380.4 - 533.5 mm (15.0 - 21.0 inch) × 279.9 mm - 307.6 mm (11.0 - 12.1 inch)
	Main unit (without stand)	566 mm (22.3 inch) × 367 mm (14.4 inch) × 85 mm (3.35 inch)
Mass	Main unit (including Height adjustable stand)	Approx. 10.2 kg (22.5 lbs.)
	Main unit (including EZ-UP stand)	Approx. 12.0 kg (26.5 lbs.)
	Main unit (without stand)	Approx. 7.2 kg (15.9 lbs.)
Movable range	Height adjustable stand	Tilt: 40° Up, 0° Down Swivel: 35° Right, 35° Left Adjustable height: 82 mm (3.2 inch) Rotation: 90° (clockwise)
	EZ-UP stand	Tilt: 25° Up, 0° Down Swivel: 172° Right, 172° Left Adjustable height: 153.1 mm (6.0 inch) Rotation: 90° (clockwise)

Environmental Conditions	Temperature	Operating temperature: 5 °C - 35 °C (41 °F - 95 °F) Storage temperature: -20 °C - 60 °C (-4 °F - 140 °F)
	Humidity	Operating humidity: 30% - 80% R.H. (no condensation) Storage humidity: 30% - 80% R.H. (no condensation)
	Pressure	Operating: 700 to 1,060 hPa Storage: 200 to 1,060 hPa
USB	Standard	USB Specification Revision 2.0
	Port	Upstream port × 1, Downstream port × 2
	Supply current	Downstream: Max. 500mA/1 port

### Main default settings (factory settings)

Auto EcoView		Off
Smoothing		3
FineContrast Mode		Custom
PowerManager		On
Input Signal		Manual
Screen Size		Full Screen
Off Timer		Disable
Menu Settings	Menu Size	Normal
	Menu Off Timer	45 sec
Language		English



**Outside Dimensions**  
**S2232W/S2242W (Height adjustable stand)**

unit : mm (inch)

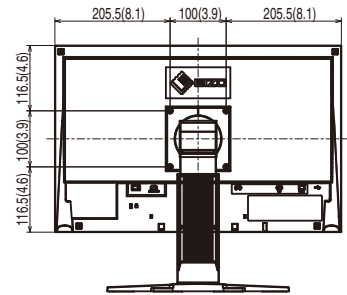
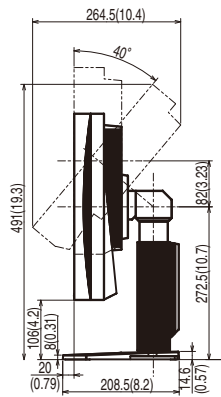
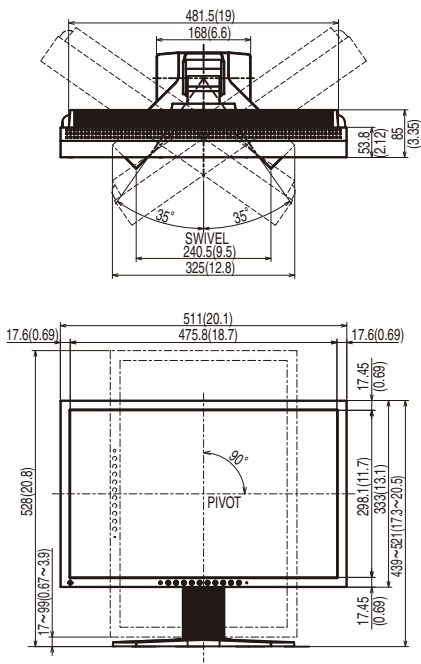

**S2232W/S2242W (Tilt stand)**

unit : mm (inch)

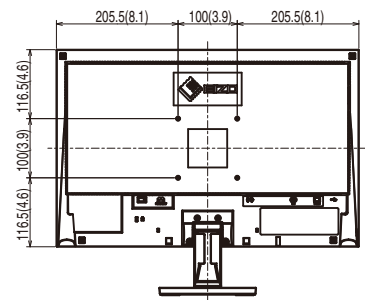
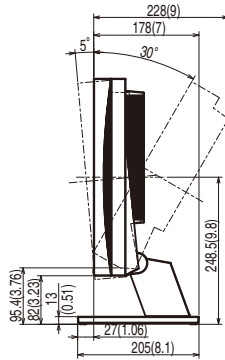
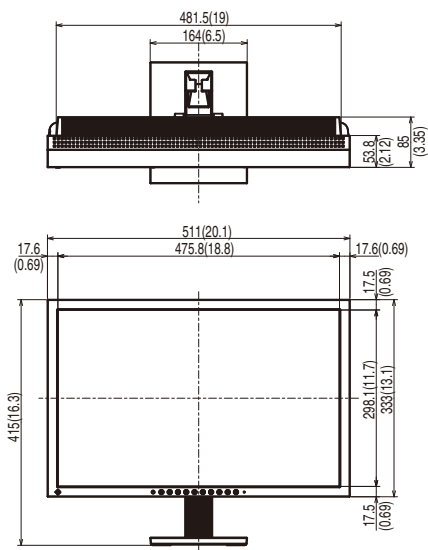

**S2232W/S2242W (EZ-UP stand)**

unit : mm (inch)

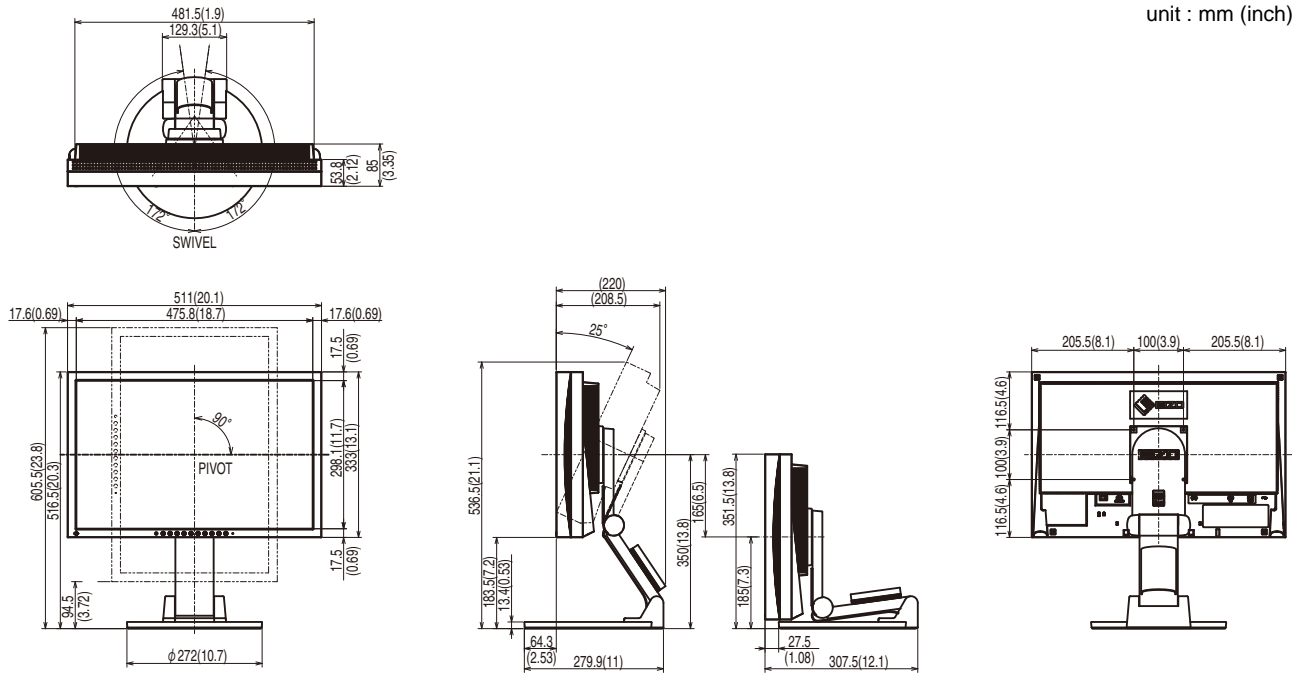

**S2432W (Height adjustable stand)**

unit : mm (inch)

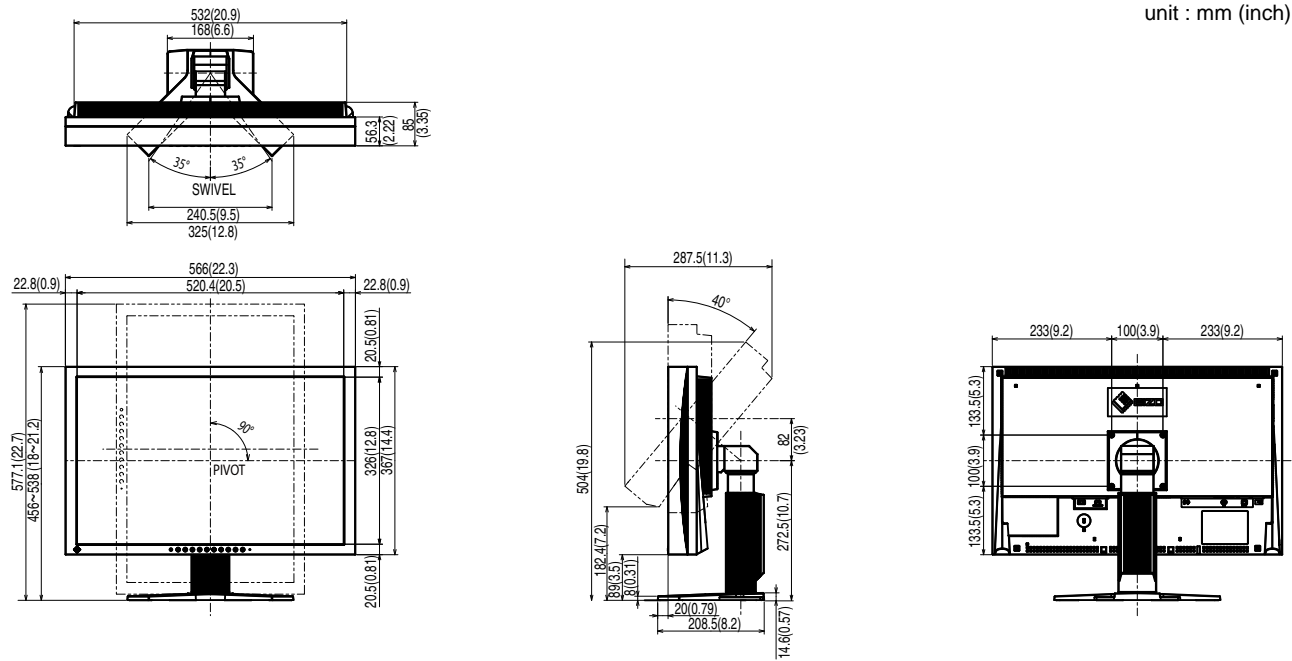

## S2432W (EZ-UP stand)

unit : mm (inch)

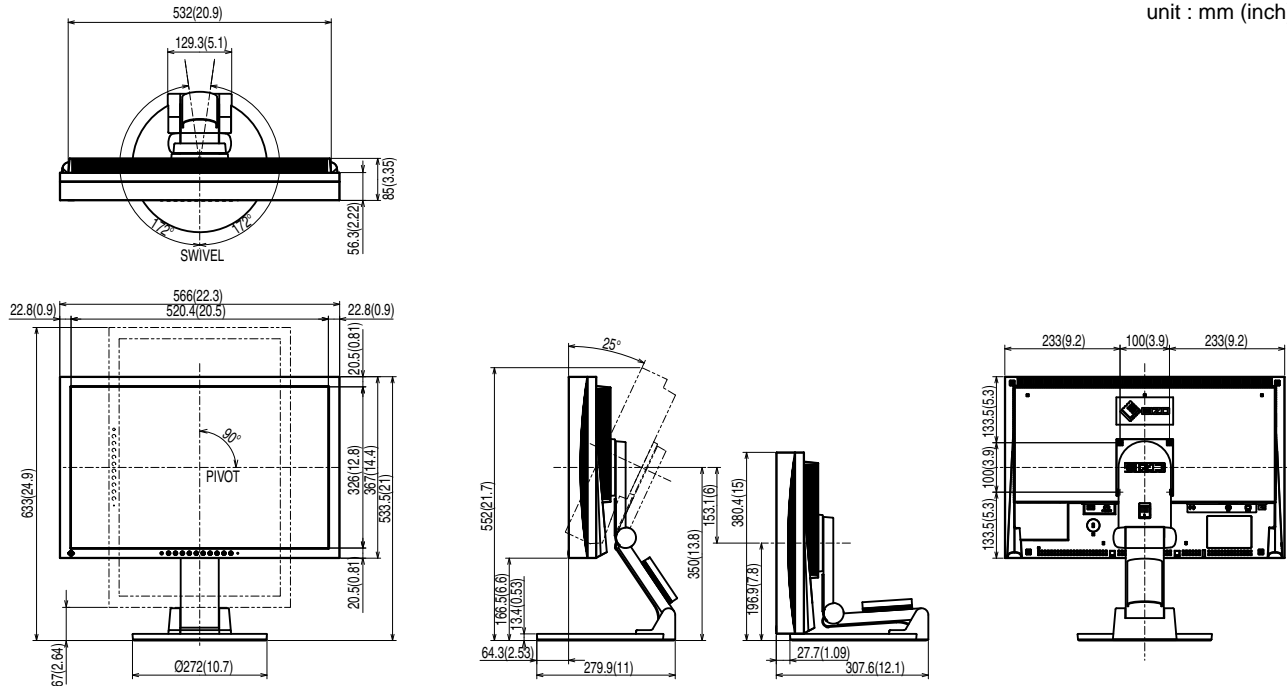

## Connector Pin Assignment

- DVI-D connector

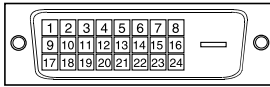

Pin No.	Signal	Pin No.	Signal	Pin No.	Signal
1	T.M.D.S. Data 2-	9	T.M.D.S. Data1-	17	T.M.D.S. Data0-
2	T.M.D.S. Data 2+	10	T.M.D.S. Data1+	18	T.M.D.S. Data0+
3	T.M.D.S. Data2/4 Shield	11	T.M.D.S. Data1/3 Shield	19	T.M.D.S. Data0/5 Shield
4	NC*	12	NC*	20	NC*
5	NC*	13	NC*	21	NC*
6	DDC Clock (SCL)	14	+5V Power	22	T.M.D.S. Clock shield
7	DDC Data (SDA)	15	Ground (return for +5V, Hsync, and Vsync)	23	T.M.D.S. Clock+
8	NC*	16	Hot Plug Detect	24	T.M.D.S. Clock-

(NC\*: No Connection)

- D-Sub mini 15-pin connector

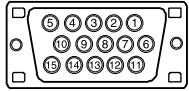

Pin No.	Signal	Pin No.	Signal	Pin No.	Signal
1	Red video	6	Red video ground	11	NC*
2	Green video	7	Green video ground	12	Data (SDA)
3	Blue video	8	Blue video ground	13	H. Sync
4	NC*	9	NC*	14	V. Sync
5	Ground	10	Ground	15	Clock (SCL)

(NC\*: No Connection)

- USB port

Upstream

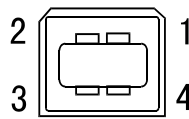

Series B connector

Upstream

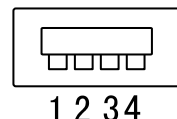

Series A connector

Contact No.	Signal	Remarks
1	VCC	Cable power
2	- Data	Serial data
3	+ Data	Serial data
4	Ground	Cable ground

### Accessories List

Cleaning Kit	EIZO ScreenCleaner
Speaker Unit	i•Sound L3*

\* May not allowed to attach the option speaker depending on the stand type.

For the latest information about the accessories, refer to our web site.

<http://www.eizo.com>

## 5-4 Glossary

### Clock

The analog input monitor needs to reproduce a clock of the same frequency as the dot clock of the graphics system in use, when the analog input signal is converted to a digital signal for image display.

This is called clock adjustment. If the clock pulse is not set correctly, some vertical bars appear on the screen.

### DDC/CI (Display Data Channel/Command Interface)

VESA provides the standardization for the interactive communication of the setting information, etc. between a PC and the monitor.

### DVI (Digital Visual Interface)

DVI is a digital interface standard. DVI allows direct transmission of the PC's digital data without loss.

This adopts the TMDS transmission system and DVI connectors. There are two types of DVI connectors. One is a DVI-D connector for digital signal input only. The other is a DVI-I connector for both digital and analog signal inputs.

### DVI DMPM (DVI Digital Monitor Power Management)

DVI DMPM is a digital interface power-saving function. The "Monitor ON (operating mode)" and "Active Off (power-saving mode)" are indispensable for DVI DMPM as the monitor's power mode.

### Gain

This is used to adjust each color parameter for red, green and blue. An LCD monitor displays the color by the light passing through the panel color filter. Red, green and blue are the three primary colors. All the colors on the screen are displayed by combining these three colors. The color tone can be changed by adjusting the light intensity (volume) passing through each color's filter.

### Gamma

Generally, the monitor brightness varies nonlinearly with the input signal level, which is called "Gamma Characteristic". A small gamma value produces a low-contrast image, while a large gamma value produces a high-contrast image.

### HDCP (High-bandwidth Digital Contents Protection)

Digital signal coding system developed to copy-protect the digital contents, such as video, music, etc. This helps to transmit the digital contents safely by coding the digital contents sent via DVI terminal on the output side and decoding them on the input side.

Any digital contents cannot be reproduced if both of the equipments on the output and input sides are not applicable to HDCP system.

### Phase

Phase means the sampling timing to convert the analog input signal to a digital signal. Phase adjustment is made to adjust the timing. It is recommended that phase adjustment be made after the clock is adjusted correctly.

### Range Adjustment

Range adjustment controls the signal output levels to display every color gradation. It is recommended that range adjustment be made before color adjustment.

**Resolution**

The LCD panel consists of numerous pixels of specified size, which are illuminated to form images. This monitor consists of 1680 (S2232W) / 1920 (S2242W/S2432W) horizontal pixels and 1050 (S2232W) / 1200 (S2242W/S2432W) vertical pixels. At a resolution of 1680× 1050 (S2232W) / 1920 × 1200 (S2242W/S2432W), all pixels are illuminated as a full screen (1:1).

**sRGB (Standard RGB)**

International standard for “color reproduction and color space” among peripheral devices (such as monitors, printers, digital cameras, scanners). sRGB allows Internet users to closely match colors as a simple color matching means for the Internet use.

**Temperature**

Color temperature is a method to measure the white color tone, generally indicated in degrees Kelvin. The screen becomes reddish at a low temperature, and bluish at a high temperature, like the flame temperature.

5000K: Slightly reddish white

6500K: Warm white like paper white

9300K: Slightly bluish white

**TMDS (Transition Minimized Differential Signaling)**

A signal transmission system for digital interface.

**VESA DPMS (Video Electronics Standards Association - Display Power Management Signaling)**

VESA provides the standardization of signals from PC (graphics board) for power saving of PC monitors. DPMS defines the signal status between PC and monitor.

## 5-5 Preset Timing

The following table shows factory preset video timing (for analog signal only).

Mode	Dot clock		Frequency	Polarity
			Horizontal: kHz Vertical: Hz	
VGA 640×480@60Hz	25.2 MHz	Horizontal	31.47	Negative
		Vertical	59.94	Negative
VGA TEXT 720×400@70Hz	28.3 MHz	Horizontal	31.47	Negative
		Vertical	70.09	Positive
VESA 640×480@72Hz	31.5 MHz	Horizontal	37.86	Negative
		Vertical	72.81	Negative
VESA 640×480@75Hz	31.5 MHz	Horizontal	37.50	Negative
		Vertical	75.00	Negative
VESA 800×600@56Hz	36.0 MHz	Horizontal	35.16	Positive
		Vertical	56.25	Positive
VESA 800×600@60Hz	40.0 MHz	Horizontal	37.88	Positive
		Vertical	60.32	Positive
VESA 800×600@72Hz	50.0 MHz	Horizontal	48.08	Positive
		Vertical	72.19	Positive
VESA 800×600@75Hz	49.5 MHz	Horizontal	46.88	Positive
		Vertical	75.00	Positive
VESA 1024×768@60Hz	65.0 MHz	Horizontal	48.36	Negative
		Vertical	60.00	Negative
VESA 1024×768@70Hz	75.0 MHz	Horizontal	56.48	Negative
		Vertical	70.07	Negative
VESA 1024×768@75Hz	78.8 MHz	Horizontal	60.02	Positive
		Vertical	75.03	Positive
VESA 1152×864@75Hz	108.0 MHz	Horizontal	67.50	Positive
		Vertical	75.00	Positive
VESA 1280×960@60Hz	108.0 MHz	Horizontal	60.00	Positive
		Vertical	60.00	Positive
VESA 1280×1024@60Hz	108.0 MHz	Horizontal	63.98	Positive
		Vertical	60.02	Positive
VESA 1280×1024@75Hz	135.0 MHz	Horizontal	79.98	Positive
		Vertical	75.03	Positive
VESA 1600×1200@60Hz (S2242W/S2432W)	162.0 MHz	Horizontal	75.00	Positive
		Vertical	60.00	Positive
VESA 1600×1200@65Hz (S2242W/S2432W)	175.0 MHz	Horizontal	81.25	Positive
		Vertical	65.00	Positive
VESA 1600×1200@70Hz (S2242W/S2432W)	189.0 MHz	Horizontal	87.50	Positive
		Vertical	70.00	Positive
VESA 1600×1200@75Hz (S2242W/S2432W)	202.5 MHz	Horizontal	93.75	Positive
		Vertical	75.00	Positive
VESA CVT 1680×1050@60Hz	146.3 MHz	Horizontal	65.29	Negative
		Vertical	59.95	Positive
VESA CVT 1920×1200@60Hz (S2242W/S2432W)	193.3 MHz	Horizontal	74.56	Negative
		Vertical	59.89	Positive
VESA CVT RB 1920×1200@60Hz (S2242W/S2432W)	154.0 MHz	Horizontal	74.04	Positive
		Vertical	59.95	Negative

### Attention

- Display position may be deviated depending on the PC connected, which may require screen adjustment using Adjustment menu.
- If a signal other than those listed in the table is input, adjust the screen using the Adjustment menu. However, screen display may still be incorrect even after the adjustment.
- When interlace signals are used, the screen cannot be displayed correctly even after screen adjustment using the Adjustment menu.



Congratulations!

The display you have just purchased carries the TCO'03 Displays label. This means that your display is designed, manufactured and tested according to some of the strictest quality and environmental requirements in the world. This makes for a high performance product, designed with the user in focus that also minimizes the Impact on our natural environment.

Some of the features of the TCO'03 Display requirements:

#### Ergonomics

- Good visual ergonomics and image quality in order to improve the working environment for the user and to reduce sight and strain problems. Important parameters are luminance, contrast, resolution, reflectance, colour rendition and image stability.

#### Energy

- Energy-saving mode after a certain time - beneficial both for the user and environment
- Electrical safety

#### Emissions

- Electromagnetic fields
- Noise emissions

#### Ecology

- The products must be prepared for recycling and the manufacturer must have a certified environmental management system such as EMAS or ISO 14000
- Restrictions on
  - chlorinated and brominated flame retardants and polymers
  - heavy metals such as cadmium, mercury and lead.

The requirements included in this label have been developed by TCO Development in co-operation with scientists, experts, users as well as manufacturers all over the world. Since the end of the 1980s TCO has been involved in influencing the development of IT equipment in a more user-friendly direction. Our labeling system with displays in 1992 and is now requested by users and IT-manufacturers all over the world.

**For more information, please visit  
[www.tcodevelopment.com](http://www.tcodevelopment.com)**



For U.S.A. , Canada, etc. (rated 100-120 Vac) Only

## FCC Declaration of Conformity

**We, the Responsible Party**

EIZO NANAOTECHNOLOGIES INC.

5710 Warland Drive, Cypress, CA 90630

Phone: (562) 431-5011

**declare that the product**

Trade name: EIZO

Model: FlexScan S2232W/S2242W/S2432W

**is in conformity with Part 15 of the FCC Rules. Operation of this product is subject to the following two conditions: (1) this device may not cause harmful interference, and (2) this device must accept any interference received, including interference that may cause undesired operation.**

This equipment has been tested and found to comply with the limits for a Class B digital device, pursuant to Part 15 of the FCC Rules. These limits are designed to provide reasonable protection against harmful interference in a residential installation. This equipment generates, uses, and can radiate radio frequency energy and, if not installed and used in accordance with the instructions, may cause harmful interference to radio communications. However, there is no guarantee that interference will not occur in a particular installation. If this equipment does cause harmful interference to radio or television reception, which can be determined by turning the equipment off and on, the user is encouraged to try to correct the interference by one or more of the following measures.

- \* Reorient or relocate the receiving antenna.
- \* Increase the separation between the equipment and receiver.
- \* Connect the equipment into an outlet on a circuit different from that to which the receiver is connected.
- \* Consult the dealer or an experienced radio/TV technician for help.

Changes or modifications not expressly approved by the party responsible for compliance could void the user's authority to operate the equipment.

### Note

Use the attached specified cable below or EIZO signal cable with this monitor so as to keep interference within the limits of a Class B digital device.

- AC Cord
- Shielded Signal Cable (enclosed)

## Canadian Notice

This Class B digital apparatus complies with Canadian ICES-003.

Cet appareil numérique de la classe B est conforme à la norme NMB-003 du Canada.

### **Hinweise zur Auswahl des richtigen Schwenkarms für Ihren Monitor**

Dieser Monitor ist für Bildschirmarbeitsplätze vorgesehen. Wenn nicht der zum Standardzubehör gehörige Schwenkarm verwendet wird, muss statt dessen ein geeigneter anderer Schwenkarm installiert werden. Bei der Auswahl des Schwenkarms sind die nachstehenden Hinweise zu berücksichtigen:

Der Standfuß muß den nachfolgenden Anforderungen entsprechen:

- a) Der Standfuß muß eine ausreichende mechanische Stabilität zur Aufnahme des Gewichtes vom Bildschirmgerät und des spezifizierten Zubehörs besitzen. Das Gewicht des Bildschirmgerätes und des Zubehörs sind in der zugehörigen Bedienungsanleitung angegeben.
- b) Die Befestigung des Standfusses muß derart erfolgen, daß die oberste Zeile der Bildschirmanzeige nicht höher als die Augenhöhe eines Benutzers in sitzender Position ist.
- c) Im Fall eines stehenden Benutzers muß die Befestigung des Bildschirmgerätes derart erfolgen, daß die Höhe der Bildschirmmitte über dem Boden zwischen 135 – 150 cm beträgt.
- d) Der Standfuß muß die Möglichkeit zur Neigung des Bildschirmgerätes besitzen (max. vorwärts: 5°, min. nach hinten  $\geq 5^\circ$ ).
- e) Der Standfuß muß die Möglichkeit zur Drehung des Bildschirmgerätes besitzen (max.  $\pm 180^\circ$ ). Der maximale Kraftaufwand dafür muß weniger als 100 N betragen.
- f) Der Standfuß muß in der Stellung verharren, in die er manuell bewegt wurde.
- g) Der Glanzgrad des Standfusses muß weniger als 20 Glanzeinheiten betragen (seidenmatt).
- h) Der Standfuß mit Bildschirmgerät muß bei einer Neigung von bis zu 10° aus der normalen aufrechten Position kippstabil sein.

### **Hinweis zur Ergonomie :**

Dieser Monitor erfüllt die Anforderungen an die Ergonomie nach EK1-ITB2000 mit dem Videosignal, 1680 × 1050 (S2232W)/1920 × 1200 (S2242W/S2432W), Digital Eingang und mindestens 60,0 Hz Bildwiederholfrequenz, non interlaced. Weiterhin wird aus ergonomischen Gründen empfohlen, die Grundfarbe Blau nicht auf dunklem Untergrund zu verwenden (schlechte Erkennbarkeit, Augenbelastung bei zu geringem Zeichenkontrast.)

Übermäßiger Schalldruck von Ohrhörern bzw. Kopfhörern kann einen Hörverlust bewirken.

Eine Einstellung des Equalizers auf Maximalwerte erhöht die Ausgangsspannung am Ohrhörer- bzw. Kopfhörerausgang und damit auch den Schalldruckpegel.

„Maschinenlärminformations-Verordnung 3. GPSGV:

Der höchste Schalldruckpegel beträgt 70 dB(A) oder weniger gemäss EN ISO 7779“

[Begrenzung des maximalen Schalldruckpegels am Ohr]

Bildschirmgeräte: Größte Ausgangsspannung 150 mV



**EIZO NANA O CORPORATION**

153 Shimokashiwano, Hakusan, Ishikawa 924-8566 Japan  
Phone: +81 76 277 6792 Fax: +81 76 277 6793

**EIZO EUROPE AB**

Lovangsvagen 14 194 61, Upplands Väsby, Sweden  
Phone: +46 8 594 105 00 Fax: +46 8 590 91 575

<http://www.eizo.com>

3rd Edition-April, 2010

03V22607C1  
(U.M-S2232W)