



Instruction Manual

DuraVision® DX0211-IP

IP Decoding Box

Software Version 5.5

Important

Please read this “Instruction Manual”, “Installation Manual”, and “Setup Manual” carefully to familiarize yourself with safe and effective usage.

-
- For the latest product information including the “Instruction Manual”, refer to our web site :

www.eizoglobal.com

Related Manuals

Setup Manual	Describes precautions and procedures for connecting network cameras and for displaying camera images on the monitor. (Installation and initialization guidance)
Installation Manual *1	Describes network camera registration, function settings, and system settings. (Detail settings guidance)
Instruction Manual (this manual) *1	Describes operation of live image screen menus. (Operation guidance)

*1 The Instruction Manual and Installation Manual for the latest software version used can be obtained from our web site. Select "Manuals" from "Support", enter "DX0211-IP" in the "Enter model name" box, and click "Search".
www.eizoglobal.com
Installation of Adobe® Acrobat® Reader® is required.

This product has been adjusted specifically for use in the region to which it was originally shipped. If operated outside this region, the product may not perform as stated in the specifications.

No part of this manual may be reproduced, stored in a retrieval system, or transmitted, in any form or by any means, electronic, mechanical, or otherwise, without the prior written permission of EIZO Corporation. EIZO Corporation is under no obligation to hold any submitted material or information confidential unless prior arrangements are made pursuant to EIZO Corporation's receipt of said information. Although every effort has been made to ensure that this manual provides up-to-date information, please note that EIZO product specifications are subject to change without notice.

CONTENTS

CONTENTS	3
Chapter 1 Product Overview	4
1-1. System Configuration	4
1-2. Cleaning	4
Chapter 2 Turning On / Off the Power	5
2-1. Turning On the Power.....	5
2-2. Turning Off the Power.....	5
Chapter 3 Operating the System	6
3-1. Live Image Screen	6
● Basic menu operations.....	7
3-2. Logging In.....	9
3-3. Setting Screen Display	11
● To change over the screen layout.....	11
● To change over the page displayed on the screen.....	12
● To switch camera image display positions.....	13
3-4. Operating Network Cameras	14
● Before operation.....	14
● To operate network cameras	15
3-5. Playing Back Video Saved on a Camera's SD Card.....	18

Chapter 1 Product Overview

This product is a device that outputs video images from a maximum of 32 network cameras*¹ to monitors connected using HDMI cable.

*1 A type of camera which converts images into network signals and transmits the signals.

1-1. System Configuration

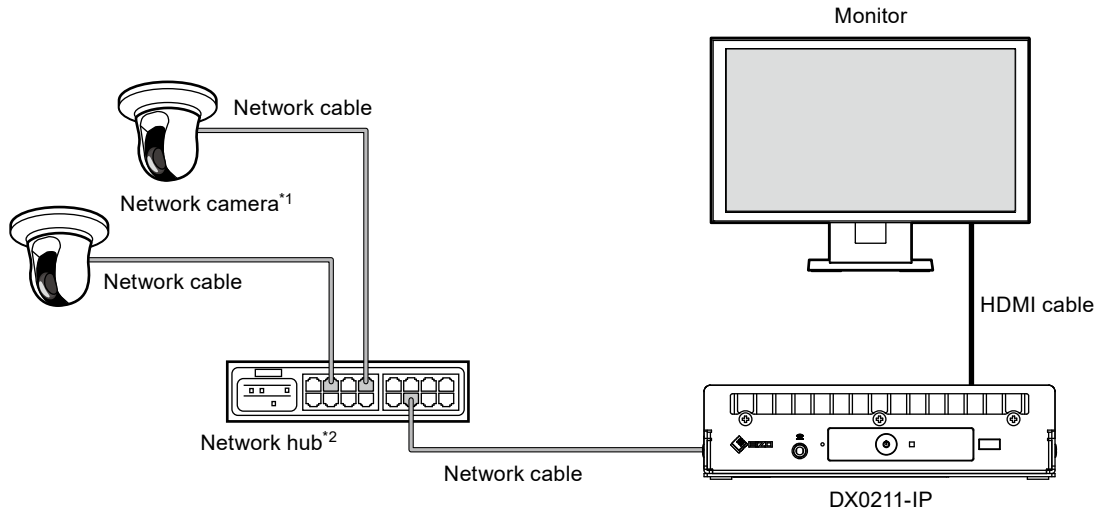

*1 Up to 48 network cameras can be registered.

*2 Use a network hub that supports PoE+. If the hub does not support the PoE+ standard, network cameras and DX0211-IP must be individually connected to the power supply.

1-2. Cleaning

Gently wipe off any dirt on the product using a clean, soft cloth moistened with water.

Attention

- Chemicals such as alcohol and disinfectant may cause variation in the glossy finish, tarnishing, fading, and deterioration of the product.
- Never use thinner, benzene, wax, or abrasive cleaners as they may damage the product.

Chapter 2 Turning On / Off the Power

2-1. Turning On the Power

1. Press on the front of the product.

The power indicator lights up blue and the live image screen is displayed.

(For details on the live image screen, refer to [“3-1. Live Image Screen” \(page 6\)](#).)

Attention

- It takes approximately 30 seconds for the live image screen to be displayed after the power is turned on. Do not turn off the power during startup.
 - When no network camera is registered, a “Not Registered” message is displayed in the network camera image display area.
-

2-2. Turning Off the Power

1. Press on the front of the product.

Chapter 3 Operating the System

This product can be operated using a USB mouse, USB keyboard, or joystick.
This chapter describes operation using a USB mouse.

Attention

- Please connect a USB mouse, USB keyboard, or joystick to the USB downstream port in advance.
- Connecting to a device with USB hub function enables operation with multiple USB devices.

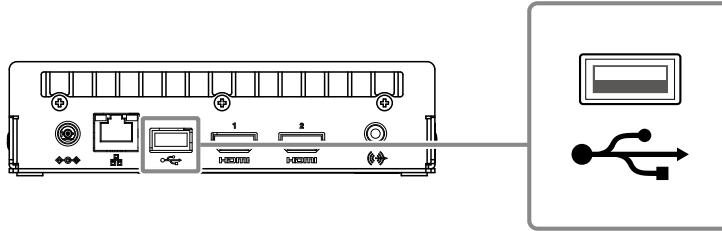

3-1. Live Image Screen

When the power of this product is turned on, the network camera image is displayed on the monitor connected using HDMI cable. Menus are displayed around the image.

Press **FULL** to hide the menus and display a full-screen image. To display the menus again, double-click any place on the screen.

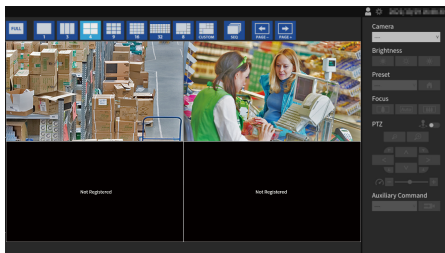

Live Image Screen
(Image and menu)

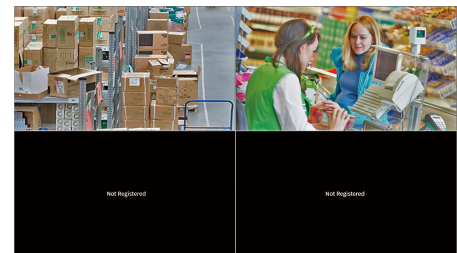

Live Image Screen
(Image only)

Note

- Double-click a camera video with the menu displayed to switch the specified camera to Full Screen Display. Double-click the camera video again to return to the menu display screen with the previously displayed layout.
- This switching can be executed from the Web browser. For information on operation from a Web browser, refer to the "Installation Manual".

● Basic menu operations

The menu is used to set display settings of the image display area and to set the settings of the system and network cameras.

Screen Layout

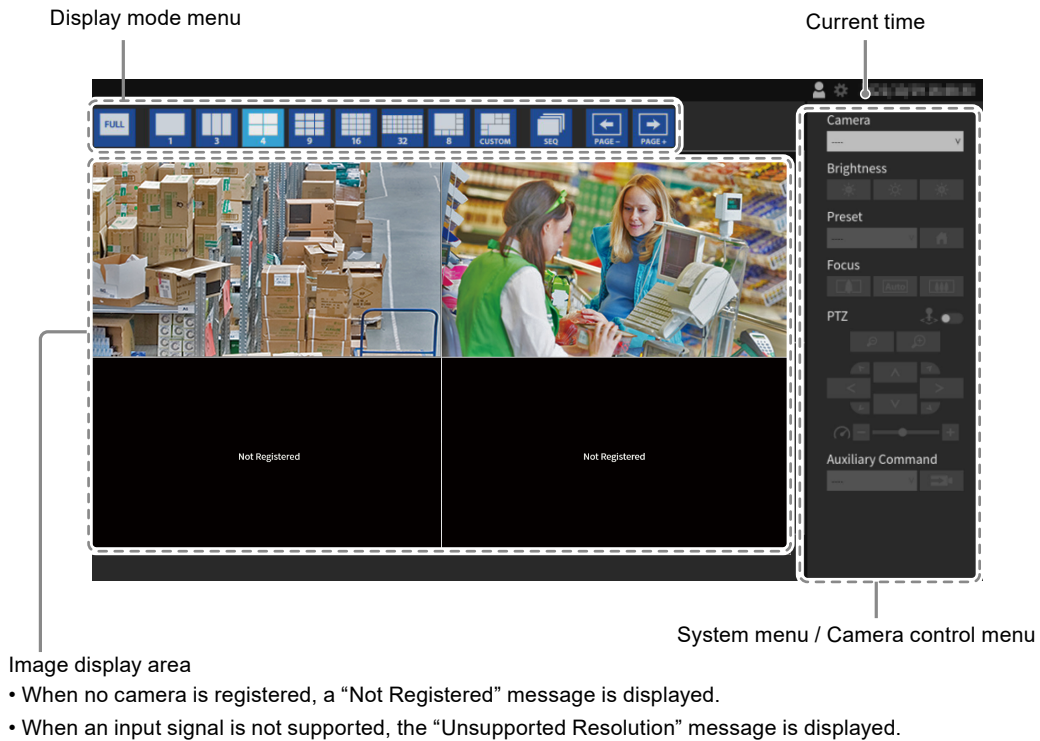













Attention

- When sequence display is enabled, the camera control menu is inoperable.

Display mode menu

Camera images displayed on the live screen can be operated. With the Enterprise edition, the icons displayed can be changed from the setting screen. For details, see the “Installation Manual”.

Display mode menu (Default settings)	Shortcut key	Details
	F	Displays or hides the menu.
       	L	Changes the display layout of the images.
	S	Turns the sequence function (function that switches the pages to be displayed on the image display area at regular intervals) on or off.
 	PageDown / PageUp	Switches the pages to be displayed on the image display area.

3-2. Logging In

Attention

- The operable range differs according to the user account level for accessing this product. Levels include “LIVE”, “CAMERA CONTROL”, and “ADMIN”. The operable range for each level is as shown below. (√: Operable, -: Inoperable)

Level \ Operation	Display mode menu	System menu		Playback	Switching camera image display positions
		Login operation	System settings		
LIVE	√	√	-	-	-
CAMERA CONTROL	√	√	-	√	√
ADMIN	√	√	√	√	√

- When the power is turned on and after logoff, the user level is “LIVE”.
- For information on setting user levels, refer to the “Installation Manual”.

- Select  (Login).
The login screen is displayed.

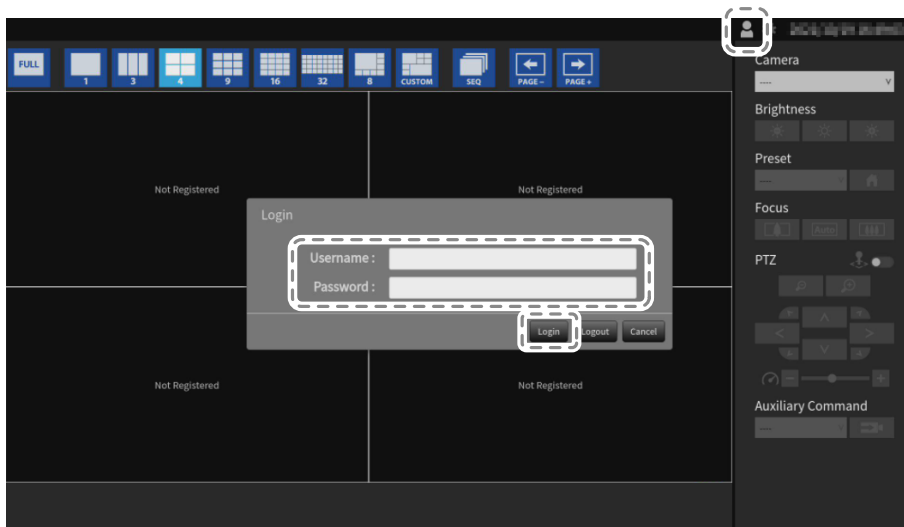

- Enter “Username” and “Password”.
Please contact the system administrator about the username and password.

Login

Username :

Password :

Note

- When the “Account Type” is set to “LDAP”, you can temporarily change the account type when logging in by checking “Allow choosing of account type on the login dialog.” under “LDAP” in advance.

Entering characters

- When entering using a USB mouse
Clicking an item that requires characters to be input, such as a text box, will display a software keyboard. When the focus is moved out of the software keyboard, the software keyboard is hidden.
 - When entering using a USB keyboard
Typed characters are entered in the text box.
3. Select “Login”.

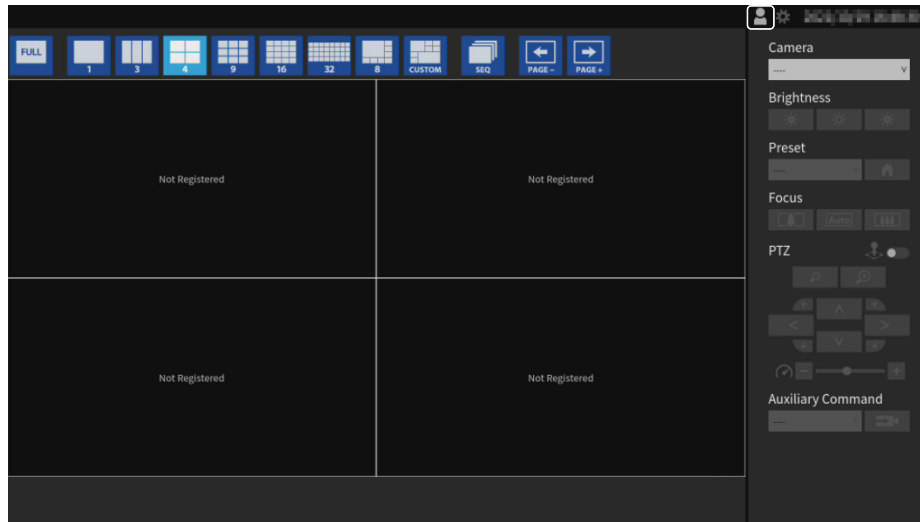

3-3. Setting Screen Display

Note

- With the Enterprise edition, the icons displayed can be changed from the setting screen. For details, see the “Installation Manual”.

● To change over the screen layout

Set the number of images to be displayed simultaneously on the live image screen.

Procedure

1. Select an icon for the layout to display.

The screen layout changes by selecting the layout icon in the display mode menu.

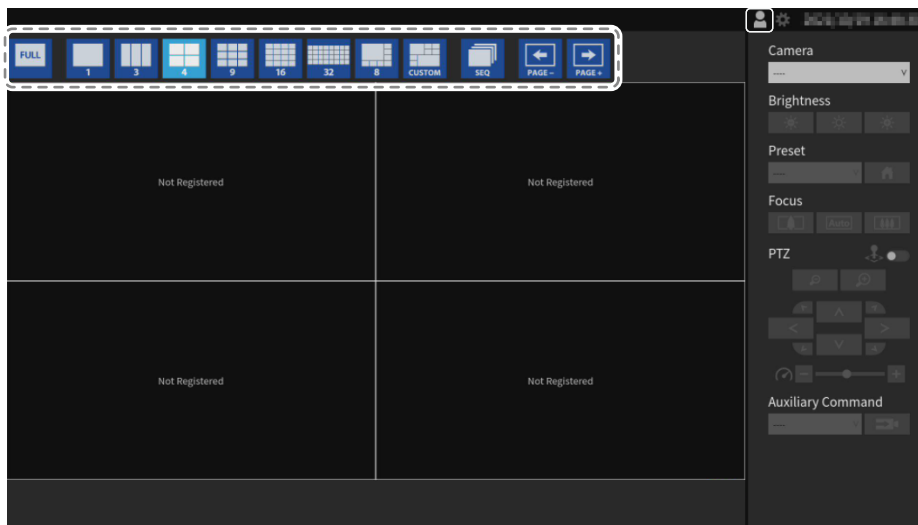

Attention

When displaying the image layout in three screens:

- Suitable for displaying portrait input images. To display portrait images, network cameras require separate settings. For details on the settings, refer to the network camera User's Manual.

Note

- When using a USB keyboard, the layout changes each time the shortcut key (L) is pressed.
- Double-click any camera window when the menu is displayed to switch to 1-screen fullscreen layout. However, this function is disabled while in Joystick Mode.

● To change over the page displayed on the screen

Camera images are displayed by changing over pages.

Pages can be changed over either manually or automatically at a set interval (sequence display).

Note

- When “Custom Screen” is specified for the screen layout, the number of pages varies depending on the specified number of screens.

Changing pages manually

Procedure

1. Select  or  in the display mode menu.

Example: 4-screen layout with 16 registered cameras

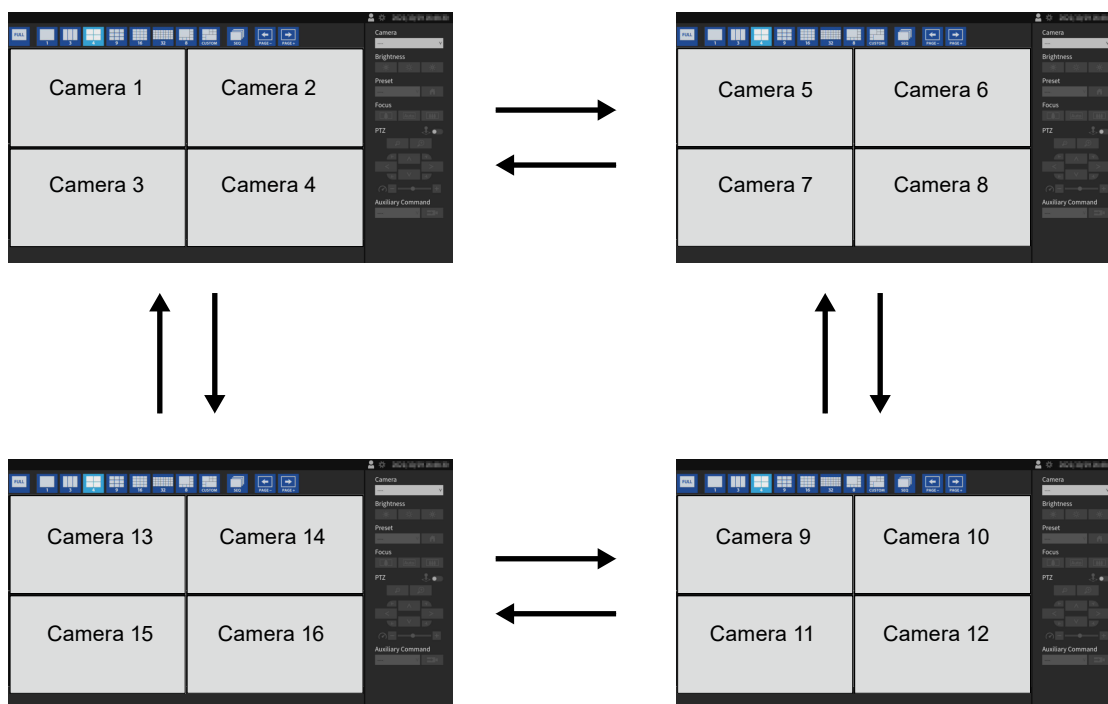

Note

- When using a USB keyboard, the pages can be changed by pressing a shortcut key (PageDown or PageUp).

Changing pages automatically (Sequence display)

Procedure

1. Select  in the display mode menu.
Pages displayed on the screen are changed over automatically at a specified interval.

Note

- The interval for page changeover can be changed (default setting: 10 sec.). For information on how to change the display interval, refer to the “Installation Manual”.
- To stop sequence display, press  again.
- When using a USB keyboard, change between starting or stopping the sequence display by pressing a shortcut key (S).

Attention

- Only pages registered for the network camera are displayed in the sequence display. Pages not registered with the camera will not be displayed.
- Select the network camera to stop the sequence display.

● To switch camera image display positions

If the image layout is displayed in multiple screens other than one screen, camera image display positions can be switched.

Attention

- It is necessary to log in as a user with a user level of “ADMIN” or “CAMERA CONTROL”.
- It is possible to switch all the display positions of the registered network cameras.

Procedure

1. Select a camera image to move using the USB mouse and drag the image and drop it on the desired camera image position.

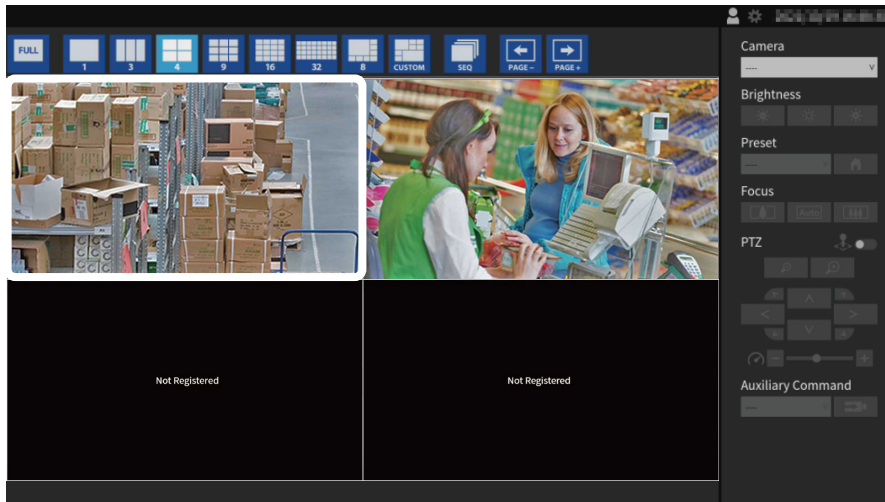

The display positions of the source and destination camera image are switched.

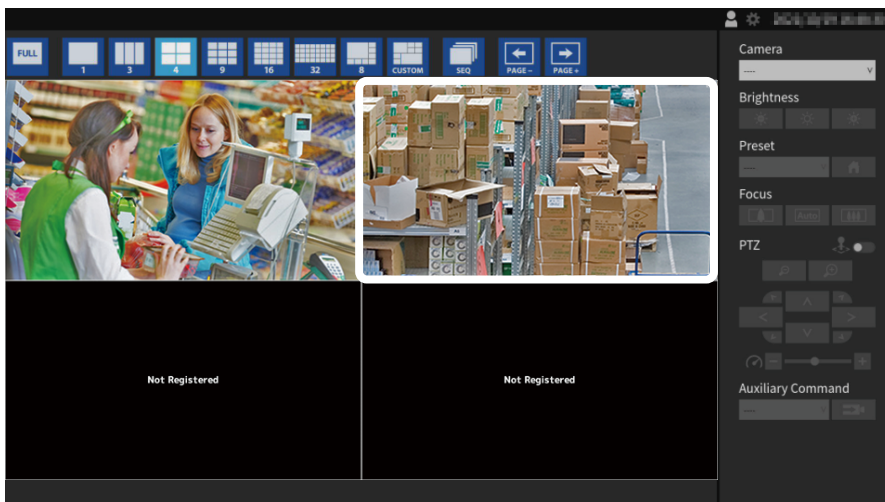

3-4. Operating Network Cameras

● Before operation

Network camera control is allowed only when the level of the user accessing this product is “CAMERA CONTROL” or “ADMIN”.

Be sure to log in to the system with a user account of this level.

Procedure

1. Select  (Login) under “System”.
The login screen is displayed.

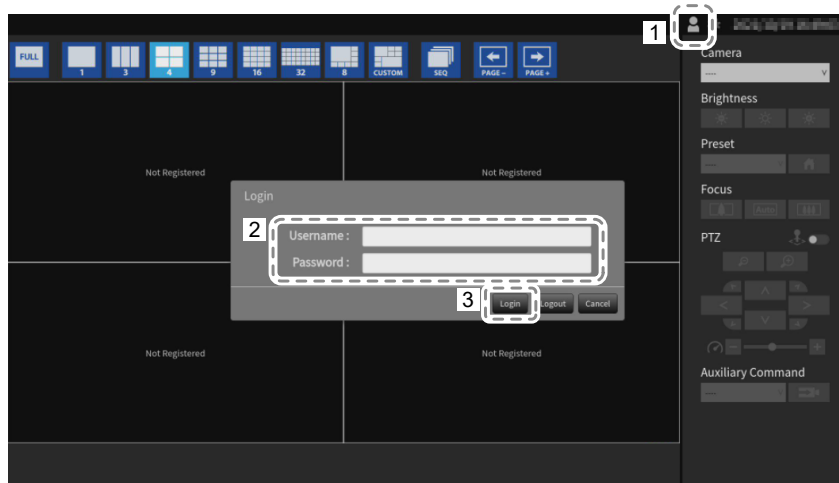

2. Enter “Username” and “Password”.
3. Select “Login”.

The display returns to the live image screen.

Note

- For entering characters, refer to [“Entering characters” \(page 10\)](#).
- The following user information is set by default.
 - Username: “admin”
 - Password: “admin”
 - User Level: “ADMIN”
- When the “Account Type” is set to “LDAP”, you can temporarily change the account type when logging in by checking “Allow choosing of account type on the login dialog.” under “LDAP” in advance.
- For information on how to configure users, refer to the “Installation Manual”.
- It is recommended that you log out after completing operations, so as to prevent a third party from operating the camera or altering the settings.
- When the Auto Login settings are configured, it is possible to log in to the system without the username and password. For details, refer to the “Installation Manual”.

Attention

- Once the Auto Login settings are configured, unauthorized operation becomes easy for a malicious third party. Restrict the configuration to the application in an environment where sufficient security is ensured.
- When the system is turned off while the user is logged in, the user is logged out from the system automatically. In such a case, you will also be logged out from the web browser.

● To operate network cameras

Procedure

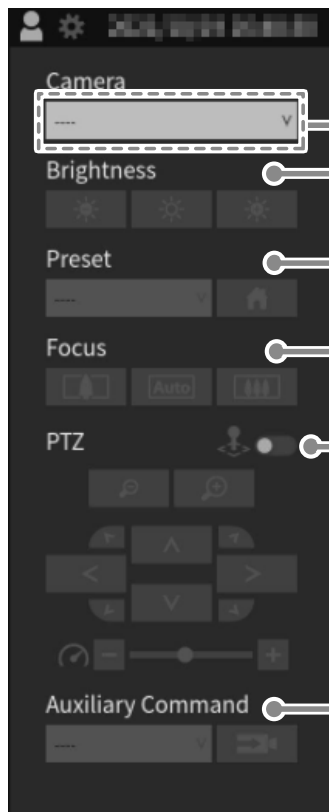

1. Select the network camera to operate.

Select a network camera displayed in the Live Image Screen. The frame around the selected camera image become bold.

2. Operate each function.







Attention

- Depending on the type of the network camera you are using, some functions may not be available.
- The network camera cannot be controlled if Protocol is set to "DirectUri" or "SRT".

Note

- The network camera to be operated can also be selected by clicking on an image displayed on the Live Image Screen with the USB mouse.
 - The position at which images in the live image screen are displayed can be changed. For details, refer to the "Installation Manual".
-

Brightness / Preset / Focus







Function	Description
Brightness	Adjust the network camera brightness.  : The image becomes darker.  : Returns the brightness to the default setting.*1  : The image becomes brighter.
Preset	Moves the camera orientation to the position registered in advance. 1. Select the preset number. Note • Select  to move the network camera orientation to the home position.
Focus	Adjust the network camera focus.  : The focus point moves closer.*2  : Focuses automatically.*3  : The focus point moves further away.*2

*1 Setting cannot be performed when "Protocol" is an "ONVIF" or "AXIS" network camera.

*2 Switches to manual adjustment mode when "Protocol" is an "ONVIF" or "AXIS" network camera.

*3 Switches to automatic adjustment mode when "Protocol" is an "ONVIF" or "AXIS" network camera.

PTZ

Function	Description
Joystick Mode	Enabled when you wish to continuously perform PTZ control of a network camera.  Joystick Mode is disabled.  Joystick Mode is enabled. Note • When using a USB keyboard, pressing the shortcut key (J) enables Joystick Mode.
Zoom	Adjust the network camera display magnification.  : Zooms out.  : Zooms in. Note • When using a USB keyboard, pressing the shortcut keys + or - adjusts the zoom.
Position	Adjusts the horizontal position (pan) and vertical position (tilt) of the network camera.  Note • When using a USB keyboard, pressing the shortcut keys Ctrl+↑, Ctrl+↓, Ctrl+←, or Ctrl+→ adjusts the position.
PTZ Adjust	Adjusts the PTZ control operating quantity. The operating quantity becomes larger the further to the right to the slider is moved.  Note • When using a USB keyboard, pressing the shortcut keys Ctrl+- or Ctrl++ adjusts the PTZ adjust.

Note

- It is also possible to perform PTZ control on the camera image by moving the USB mouse cursor onto the selected camera image. This function is enabled when the camera image screen size is 352 x 198 (16-screen layout) or above.

Auxiliary Command

Function	Description
Auxiliary Command	<p>Operates the auxiliary functions of a network camera, or executes actions of registered event rules.</p> <ol style="list-style-type: none">1. Select the "Auxiliary Command" list box.2. Select . <ul style="list-style-type: none">• The auxiliary functions of the network camera can only be operated with specific devices that have protocols set to "ONVIF" or "Panasonic".• Event rule events can only be executed when a camera is not selected.

3-5. Playing Back Video Saved on a Camera's SD Card

Video saved on a camera's SD card can be played back on the Playback screen.

Attention

- This function is only available when the software edition is "Enterprise" and the "Playback" extension is enabled. When this feature is enabled, the "Playback" tab and "Live" tab are displayed.
- It is necessary to log in as a user with a user level of "ADMIN" or "CAMERA CONTROL".
- If the video clock is not correctly displayed, check the time zone settings of the product main unit and the network camera.
- Playback is not supported for files recorded in MJPEG.
- Can only be used when "Protocol" is "Panasonic" or "AXIS".
- The following restrictions apply when "Protocol" is "Panasonic".
 - If the Date Filter is not enabled, up to 50 files are displayed in the "Recording Date" list starting from the oldest file.
 - One recording may be split into multiple files.
 - Only files recorded as recording stream 1 on the network camera can be played.
 - If the recording compression format is JPEG, playback will fail.
 - For multi-sensor cameras, only the channels set in the camera registration can be played.
- The following restrictions apply when "Protocol" is "AXIS".
 - If the Date Filter is not enabled, up to 50 files are displayed in the "Recording Date" list starting from the newest file.
 - Since one recording will become a single file, longer recordings will have a large file size and playback may not be possible.
 - Since one recording will become a single file, the file does not appear in the "Recording Date" list until the recording has stopped. If you set up the network camera using the following procedure, you can continue recording while splitting files at set intervals.
 1. Create a pulse in the event function "Schedule", and set the interval to 2 minutes (when dividing the video every 2 minutes).
 2. In the event function "Rules", set "Condition" to one created pulse event, set "Action" to "Video Recording", set "Pre-Buffer" to "01", set "Post-Buffer" to "01:59", and save.

1. Select "Playback" in Live Image Screen.

The "Playback" screen is displayed.

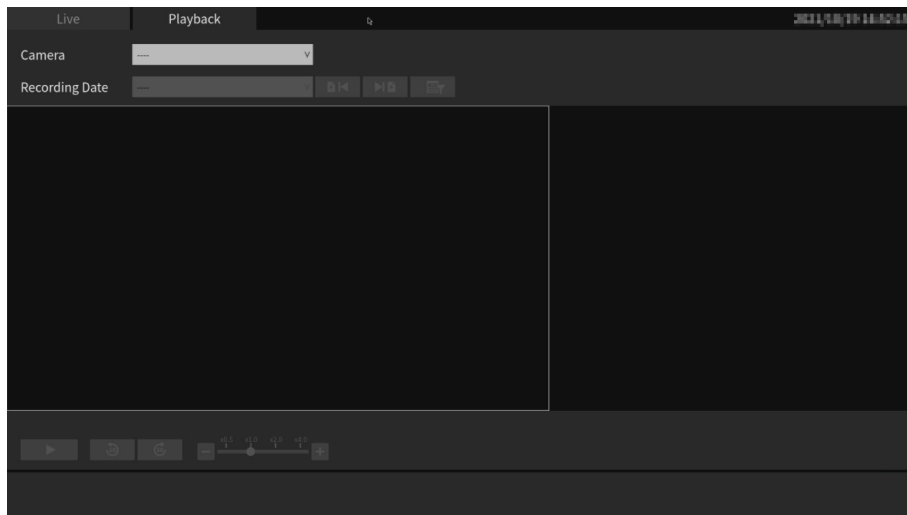



2. Select the camera by "Camera Name".

Attention

- When the "Failover" extension is enabled, the "Switch to Failover Cameras" check box is displayed. When "Switch to Failover Cameras" is enabled, the cameras that can be selected will switch to those registered for failover.

3. Select the video file to playback in “Recording Date and Time”.

Up to 50 files can be displayed in the “Recording Date” list (files being recorded are not displayed). You can also select the previous file with  and select the next file with .

By using the date filter function , you can filter the videos displayed in the “Recording Date and Time” list by date.

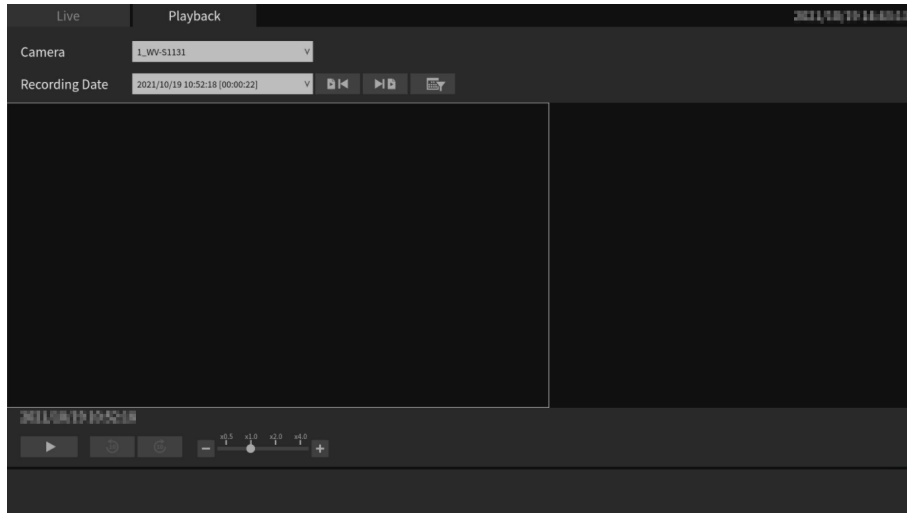

Date Filter

Enable “Date Filter” , and specify the date. Select “OK” to display up to 50 videos in the “Recording Date and Time” list starting from the specified date.

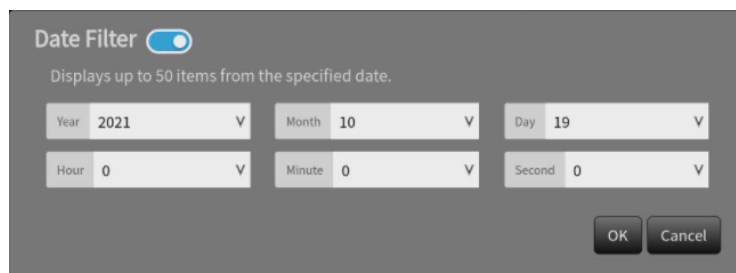







4. Press .

The video file will start downloading and the video will be played when downloading is complete.

Attention

- If the video file is a large size, the download may be interrupted and video playback may not be possible.
-

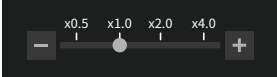
Playback Operation

Function	Detail
Play / Pause	Play / Pause a video.  : Play  : Pause
10 seconds Rewind	Rewind a video by 10 seconds. 
10 seconds Fast-Forward	Fast-forward a video by 10 seconds. 
Adjust Playback Speed	Select the video playback speed from x0.5, x1.0, x2.0, and x4.0. 
Timeline	While playing a video, display the timeline by placing the mouse pointer in the video display area or selecting the video display area is with the keyboard. Operate the timeline to change the playback position.  Attention <ul style="list-style-type: none"> • If you cannot get the end time of the video from the camera, the timeline cannot be displayed.

