

Guia de Instalação

ColorEdge® CG2730

Monitor de LCD com gerenciamento de cores

Importante















Leia as PRECAUÇÕES, este Guia de Instalação e o Manual do usuário armazenados no CD-ROM com atenção para se familiarizar com o uso seguro e eficiente deste produto. Conserve este guia para futura referência.

Para as últimas informações de produto, incluindo o Manual do Usuário, consulte o nosso site.

<http://www.eizoglobal.com>



1. Conteúdo do pacote

 <ul style="list-style-type: none">• Monitor	 <ul style="list-style-type: none">• Setup Guide (Guia de Instalação)	 <ul style="list-style-type: none">• PRECAUTIONS (PRECAUÇÕES)
 <ul style="list-style-type: none">• Adjustment Certificate (Certificado de Ajuste)	 <ul style="list-style-type: none">• EIZO LCD Utility Disk	 <ul style="list-style-type: none">• ColorNavigator Quick Reference (Guia de referência rápida ColorNavigator)
 <ul style="list-style-type: none">• DD200DL DVI Dual Link cabo	 <ul style="list-style-type: none">• PM200 DisplayPort cabo	
 <ul style="list-style-type: none">• UU200SS (USB 3.0) cabo USB	 <ul style="list-style-type: none">• Cabo de alimentação	
 <ul style="list-style-type: none">• Parafusos de montagem	 <ul style="list-style-type: none">• ScreenCleaner (Kit de limpeza)	
 <ul style="list-style-type: none">• Protetor do monitor	 <ul style="list-style-type: none">• Manual do Usuário do Protetor do Monitor	

2. Conexões

1.

2.

3.

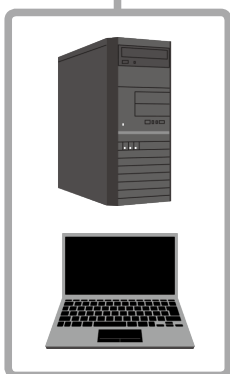
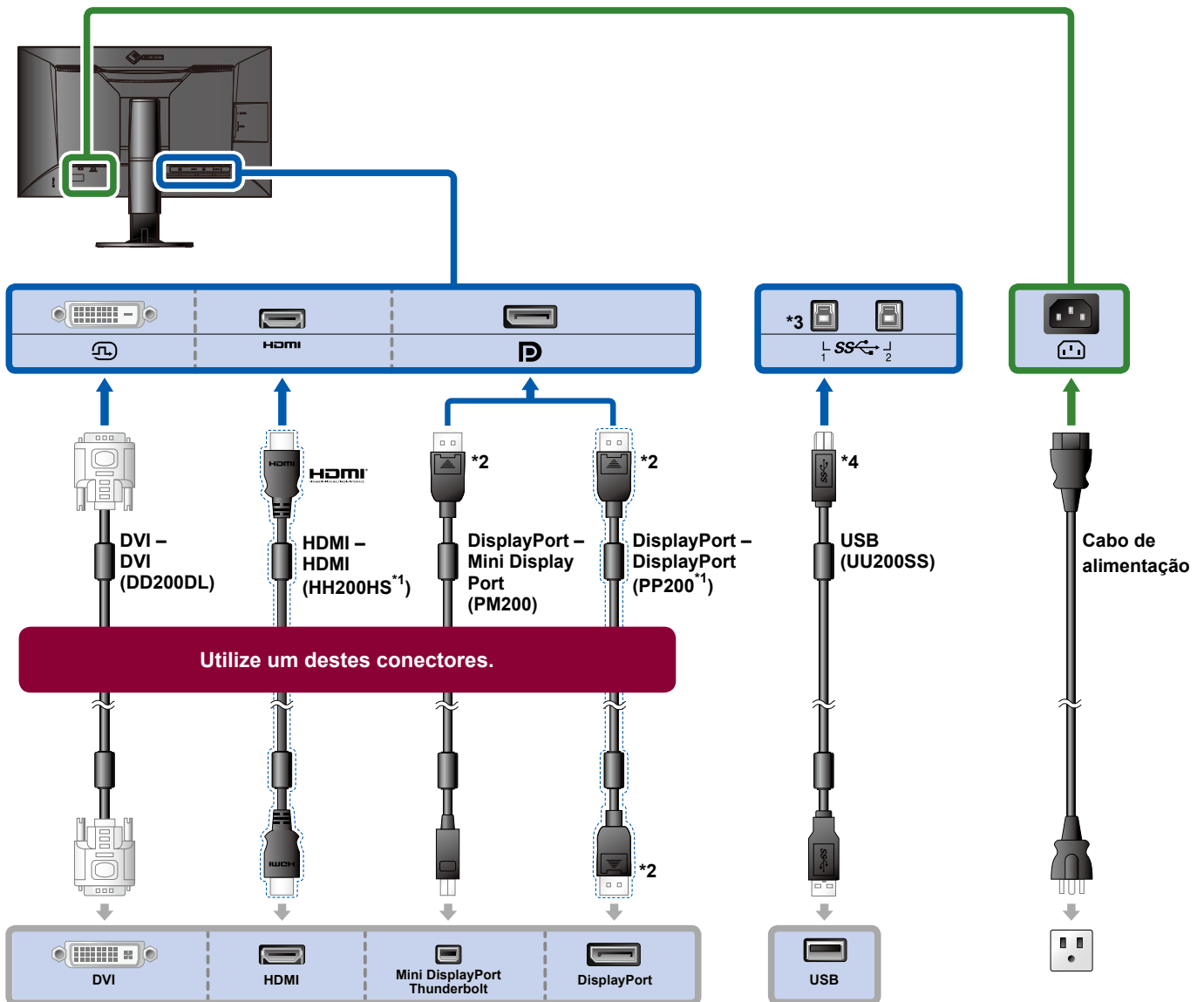

*1 opção

*2 Como remover

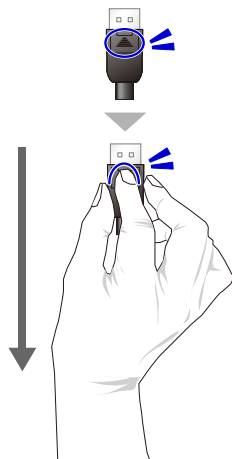

*3 Usar porta 1. Por padrão, a porta 2 USB upstream é desabilitada. Para modificar as configurações, consulte o Manual do Usuário do monitor.

*4 Certifique-se sempre de que este cabo esteja conectado ao usar o ColorNavigator 6.

4.

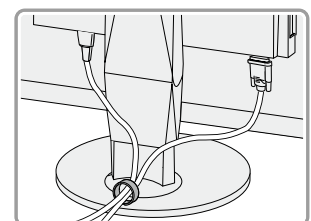
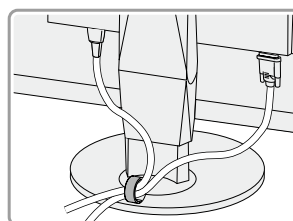

A utilização do suporte de cabo atrás da armação mantém os cabos juntos de forma organizada.

3. Ajuste de ângulo e altura

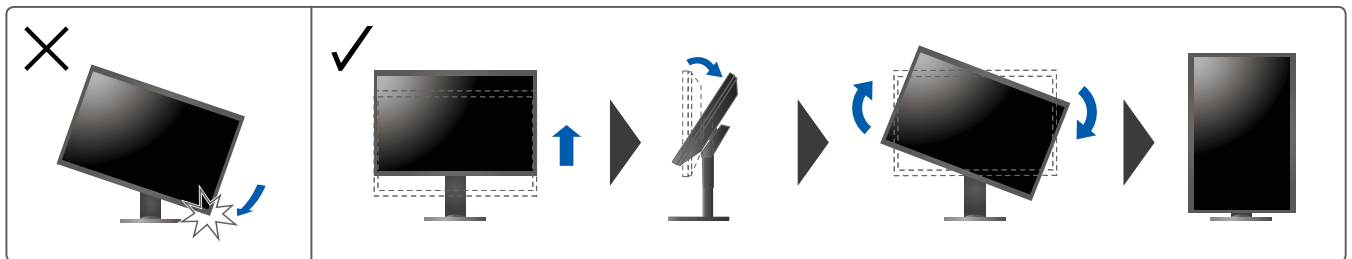
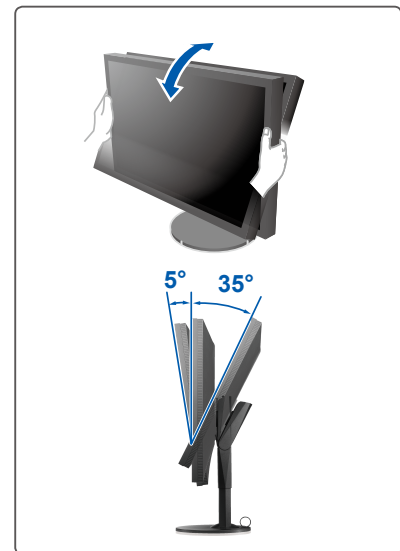
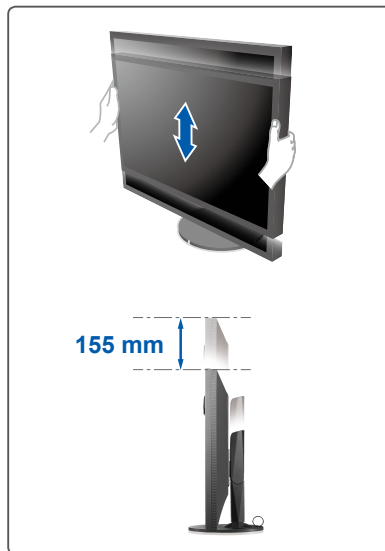
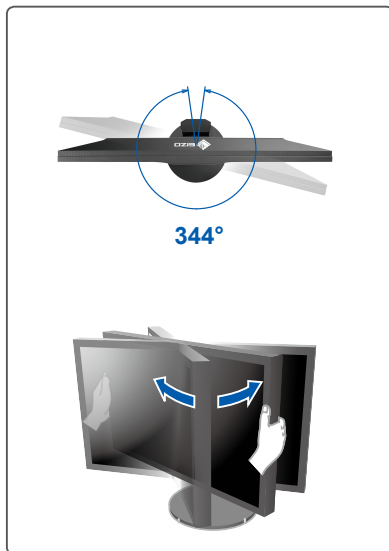

4. Tela do vídeo

1. Interruptor de alimentação geral

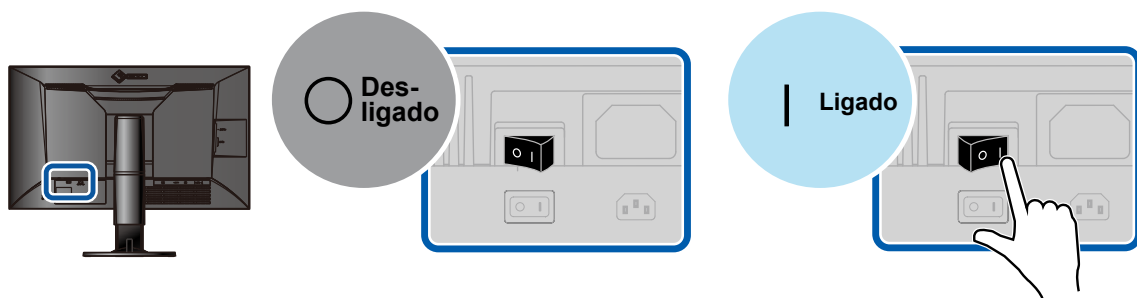

2. Botão ligar/desligar

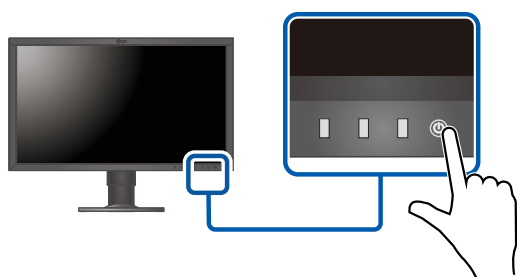

3. Resolução recomendada



5. Língua

1.

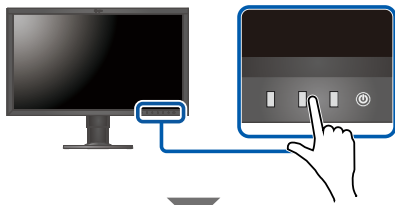

2.

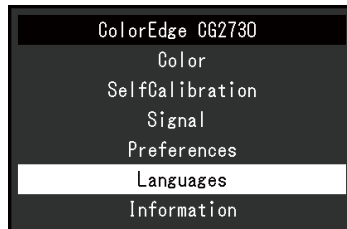
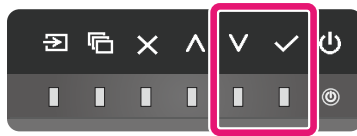

3.

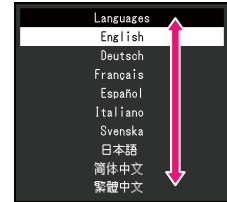
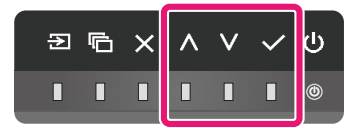

6. Protetor



- Para mais detalhes sobre a instalação, consulte o Manual do Usuário do Protetor do Monitor.

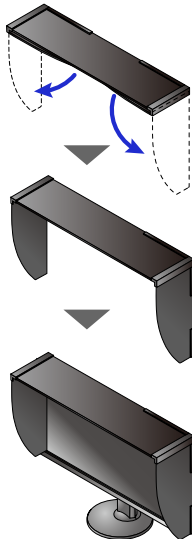

SelfCalibration

Permite que você realize a calibragem periodicamente.

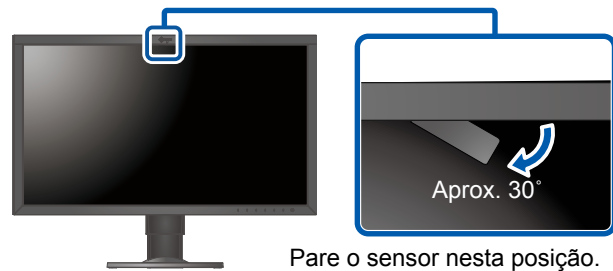

Pare o sensor nesta posição.



- Para mais detalhes sobre SelfCalibration, consulte o Manual do Usuário do monitor no CD-ROM.

ColorNavigator



- Para as instruções de operação, consulte a "Consulta rápida" e o Manual do Usuário do ColorNavigator (armazenado no CD-ROM).

Problema de falta de imagem

Toque  no monitor para ligar a energia.

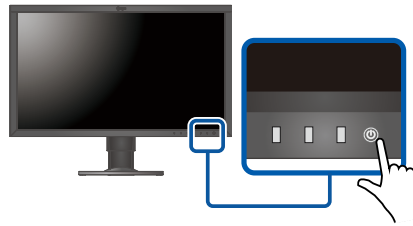

 ilumina-se de branco.

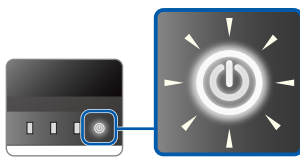

 não acende.

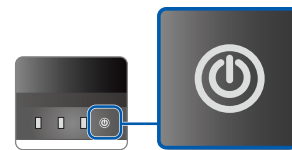

Ligue o monitor.

- Ligue corretamente o interruptor de energia principal na parte de trás do monitor.
- Confira se o cabo de alimentação está inserido corretamente.

Uma mensagem aparece na tela.



Inserir um sinal.

- Toque  para alternar o terminal de entrada no qual o cabo de sinal está conectado.*1
- Confira que o cabo de sinal está conectado corretamente.
- O PC pode estar em modo de hibernação. Experimente o mouse ou o teclado.
- Verifique se o PC está ligado.

Se as etapas acima mencionadas não resolverem o problema, experimente reinicializar o PC.

- Ligue corretamente o interruptor de energia principal na parte de trás do monitor.
- Reinicialize o PC.

Uma mensagem aparece na tela.



O sinal correto não é inserido pelo PC.

- Reinicialize o PC.
- O disco gráfico no PC pode não estar funcionando corretamente. Para mais detalhes, contate o revendedor ou o fabricante do computador.

*1

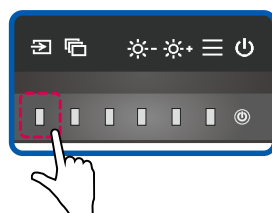

Nenhuma mensagem aparece na tela.

- "Brightness" (Brilho).^{*2}
- Reinicialize o PC.

*2

