

User's Manual

ColorEdge[®] CG2730

Color Management LCD Monitor

Important

Please read PRECAUTIONS, this User's Manual, and the Setup Guide (separate volume) carefully to familiarize yourself with safe and effective usage.

-
- Please refer to the Setup Guide for basic information ranging from connection of the monitor to a PC to using the monitor.
 - The latest User's Manual is available for download from our web site: www.eizoglobal.com
-



Location of Caution Statement

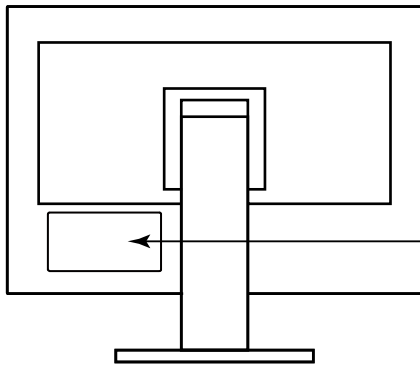

WARNING
RISK OF ELECTRIC SHOCK. DO NOT OPEN.

AVERTISSEMENT
RISQUE DE CHOC ELECTRIQUE. NE PAS OUVRIR.

WARNUNG
GEFAHR DES ELEKTRISCHEN SCHLAGES. RÜCKWAND NICHT ENTFERNEN.

警告
触电危険，请勿打开后盖。

警告
感電の恐れあり，カバーをあけないでください。

The equipment must be connected to a grounded main outlet.
L'appareil doit être relié à une prise avec terre.
Jordet stikkontakt skal benyttes når apparatet tilkobles datanett.
Apparaten skall anslutas till jordat nätuttag.
设备必须连接到接地的电源插座。
電源コードのアースは必ず接地してください。

This product has been adjusted specifically for use in the region to which it was originally shipped. If operated outside this region, the product may not perform as stated in the specifications.

No part of this manual may be reproduced, stored in a retrieval system, or transmitted, in any form or by any means, electronic, mechanical, or otherwise, without the prior written permission of EIZO Corporation. EIZO Corporation is under no obligation to hold any submitted material or information confidential unless prior arrangements are made pursuant to EIZO Corporation's receipt of said information. Although every effort has been made to ensure that this manual provides up-to-date information, please note that EIZO monitor specifications are subject to change without notice.

Notice for This Monitor

Aside from general purposes like creating documents and viewing multimedia content, this product is also suited to applications such as creating images and graphics, and digital photo processing, where accurate color reproduction is a priority.

This product has been adjusted specifically for use in the region to which it was originally shipped. If the product is used outside the region, it may not operate as specified in the specifications.

This product may not be covered by warranty for uses other than those described in this manual.

The specifications noted in this manual are only applicable when the following are used:

- Power cords provided with the product
 - Signal cables specified by us
-

Only use optional products manufactured or specified by us with this product.

If you place this product on a lacquer-coated desk, the color may adhere to the bottom of the stand due to the composition of the rubber. Check the desk surface before use.

It takes about 3 minutes (under our measurement conditions) for the performance of electrical parts to stabilize. Please wait 30 minutes or more after the monitor power has been turned on, and then adjust the monitor.

Monitors should be set to a lower brightness to reduce changes in luminosity caused by long-term use and maintain a stable display.

When the screen image is changed after displaying the same image for extended periods of time, an afterimage may appear. Use the screen saver or power save function to avoid displaying the same image for extended periods of time.

If the monitor displays continuously over a long period of time, dark smudges or burn-in may appear. To maximize the life of the monitor, we recommend the monitor be turned off periodically.

Periodic cleaning is recommended to keep the monitor looking new and to prolong its operation lifetime (refer to [“Cleaning” \(page 4\)](#)).

The LCD panel is manufactured using high-precision technology. Although, missing pixels or lit pixels may appear on the LCD panel, this is not a malfunction. Percentage of effective dots: 99.9994 % or higher.

The backlight of the LCD panel has a fixed lifetime. When the screen becomes dark or begins to flicker, please contact your local EIZO representative.

Do not press on the panel or edge of the frame strongly, as this may result in display malfunctions, such as interference patterns, etc. If pressure is continually applied to the panel, it may deteriorate or damage your panel. (If the pressure marks remain on the panel, leave the monitor with a black or white screen. The symptom may disappear.)

Do not scratch or press on the panel with any sharp objects, as this may result in damage to the panel. Do not attempt to brush with tissues as this may scratch the panel.

When the monitor is cold and brought into a room or the room temperature goes up quickly, dew condensation may occur on the interior and exterior surfaces of the monitor. In that case, do not turn the monitor on. Instead wait until the dew condensation disappears, otherwise it may cause some damage to the monitor.

Cleaning

Attention

- Chemicals such as alcohol and antiseptic solution may cause gloss variation, tarnishing, and fading of the cabinet or panel, and also quality deterioration of the image.
 - Never use any thinner, benzene, wax, and abrasive cleaner, which may damage the cabinet or panel.
-

The stains on the cabinet and panel surface can be removed by using the provided ScreenCleaner.

To Use the Monitor Comfortably

- An excessively dark or bright screen may affect your eyes. Adjust the brightness of the monitor according to the environmental conditions.
- Staring at the monitor for a long time tires your eyes. Take a 10-minute rest every hour.

Contents

Notice for This Monitor	3	Chapter 6 Reference	39
Cleaning	4	6-1. Removing the Stand	39
To Use the Monitor Comfortably	4	6-2. Attaching the Optional Arm.....	40
Contents	5	6-3. Attaching/Detaching the Cable Holder	42
Chapter 1 Introduction	6	6-4. Connecting Multiple External Devices	43
1-1. Features	6	6-5. Making Use of USB (Universal Serial Bus).....	44
1-2. Controls and Functions	8	● Required System Environment	44
● Front	8	● Connection Procedure (Setup of USB Function).....	45
● Rear.....	9	6-6. Specifications	46
1-3. Compatible Resolutions	10	● Outside Dimensions	48
● DVI.....	10	● Main Default Settings	49
● DisplayPort.....	11	● Accessories.....	49
● HDMI	12	Chapter 7 Glossary	50
1-4. Changing the PC Display Settings.....	13	Appendix	52
● Windows 10.....	13	Trademark	52
● Windows 8.1 / Windows 7	13	License	52
● macOS	14	FCC Declaration of Conformity	53
Chapter 2 Basic Adjustments/Settings	15		
2-1. Switch Operation Method	15		
2-2. Switching Input Signals	15		
2-3. Switching the Display Mode (color mode)....	16		
● Display Modes.....	16		
2-4. Adjusting the Brightness.....	16		
Chapter 3 Advanced Adjustments/Settings	17		
3-1. Basic Operation of the Setting Menu	17		
3-2. Setting Menu Functions	19		
● Color	19		
● SelfCalibration.....	24		
● Signal	27		
● Preferences.....	29		
● Languages	32		
● Information	32		
Chapter 4 Administrator Settings	33		
4-1. Basic Operation of the "Administrator Settings" Menu.....	33		
4-2. "Administrator Settings" Menu Functions	34		
Chapter 5 Troubleshooting	35		
5-1. No Picture	35		
5-2. Imaging Problems.....	36		
5-3. Other Problems	37		
5-4. Built-in Calibration Sensor and SelfCalibration Problems.....	38		

Chapter 1 Introduction

Thank you very much for choosing an EIZO color LCD monitor.

1-1. Features

- 27" widescreen
- Wide color gamut display (Adobe® RGB coverage: 99 %)
- Achieves contrast ratio of 1500:1*1
 - A high contrast ratio allows for display of crisper black.
 - *1 Standard value. When "DUE Priority" is set to "Brightness"
- Resolution: Supports 2560×1440
- IPS panel with 178° horizontal and vertical wide viewing angles
- The monitor display stabilizes within approximately 3 minutes after the monitor is turned on.*2
 - *2 According to EIZO measurement conditions. However, if performing SelfCalibration (page 24), it is necessary to wait at least 30 minutes after turning on the power, in order to obtain correct measurement results.
- Frame synchronization mode supported (23.75 - 30.5 Hz, 47.5 - 61.0 Hz)
- Color mode function
 - Reproduces a color temperature, gamma, and gamut compliant with the following standards.
 - Adobe®RGB / sRGB
 - See "Chapter 3 Advanced Adjustments/Settings" (page 17)
- This product is equipped with a built-in calibration sensor, and supports SelfCalibration in which the monitor executes calibration independently.
 - See "SelfCalibration" (page 24)
- Compatible with Color Management Software "ColorNavigator 7", which enables you to calibrate monitor characteristics and generate color profiles
- Equipped with a USB Hub function that supports USB 3.0
 - Achieves high-speed data transfers of up to 5 Gbps, which enables transfers of large amounts of data to and from USB memory devices in a short amount time.
 - Also, the USB downstream port supports quick charging, so you can recharge your smartphone or tablet in a short period of time.
 - See "6-5. Making Use of USB (Universal Serial Bus)" (page 44) and "USB CHARGE Port" (page 30)
- Displays HDCP (High Bandwidth Digital Protection) protected content.

Attention

Be careful of the following points when using the built-in calibration sensor.



Do not touch the built-in calibration sensor.

It may reduce the measurement accuracy of the built-in calibration sensor, or result in injury or equipment damage.

Attention

- A high temperature or high humidity environment may affect the measurement accuracy of the built-in calibration sensor. We suggest storing and using the monitor under the following conditions.
 - Temperature 30°C or less
 - Humidity 70 % or lessAvoid storing or using the sensor where it may be exposed to direct sunlight.
 - Since the measurement result for the built-in sensor may be affected, ensure that the level of ambient light that enters the receiver part of the built-in sensor does not change significantly during measuring. Do not touch the screen while measurement is in progress.
 - The use of a monitor hood is recommended.
 - While measuring, do not bring your face or any objects close to the monitor, do not look into the sensor.
 - Set the monitor in the environment so that external light does not enter the sensor directly.
-
-

Note

- This monitor supports a portrait orientation display. When using the screen in a portrait position, you can change the orientation of the Setting menu (see [“Menu Rotation” \(page 29\)](#)).
 - When using the monitor screen in a portrait position, the graphics board supporting portrait display is required. When placing the monitor in a portrait position, settings of your graphics board need to be changed. Refer to the User's Manual of the graphics board for details.
-

1-2. Controls and Functions

● Front

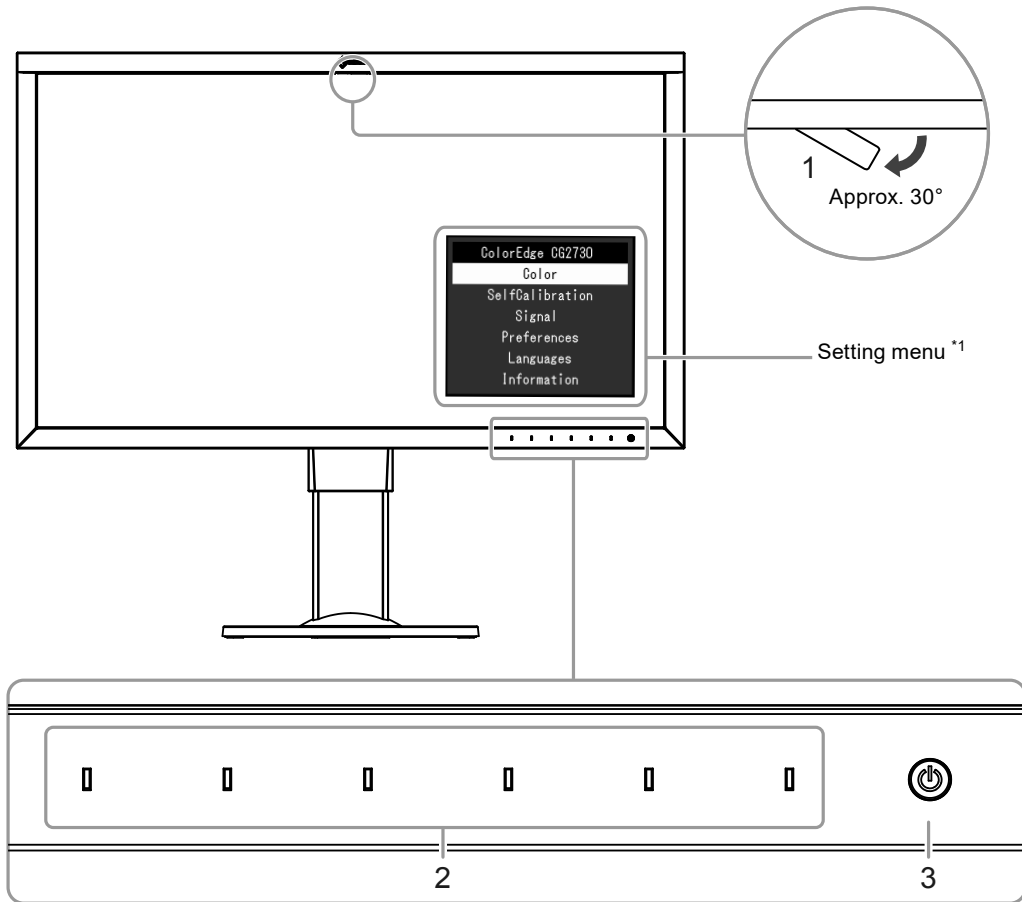

<p>1. Built-in calibration sensor</p>	<p>Executes calibration for independent monitors. “SelfCalibration” (page 24) (Self calibration)</p> <p>Attention</p> <ul style="list-style-type: none"> Do not touch the sensor as this will affect the measurement accuracy.
<p>2. Operation switches</p>	<p>Displays menus. Operate the switches according to the operation guide. The switch indicator is lit white when you turn the power on.</p>
<p>3. Power switch</p>	<p>Turns the power on or off. The switch indicator is lit when you turn the power on. The indicator color differs depending on the monitor's operation status.</p> <p>White : Operating</p> <p>Flashing white : Indicates that recalibration is required if the (quickly twice) SelfCalibration schedule (page 25) is set.</p> <p>Orange : Power saving mode</p> <p>OFF : Power off</p>

*1 See [“3-1. Basic Operation of the Setting Menu” \(page 17\)](#) for how to use.

● Rear

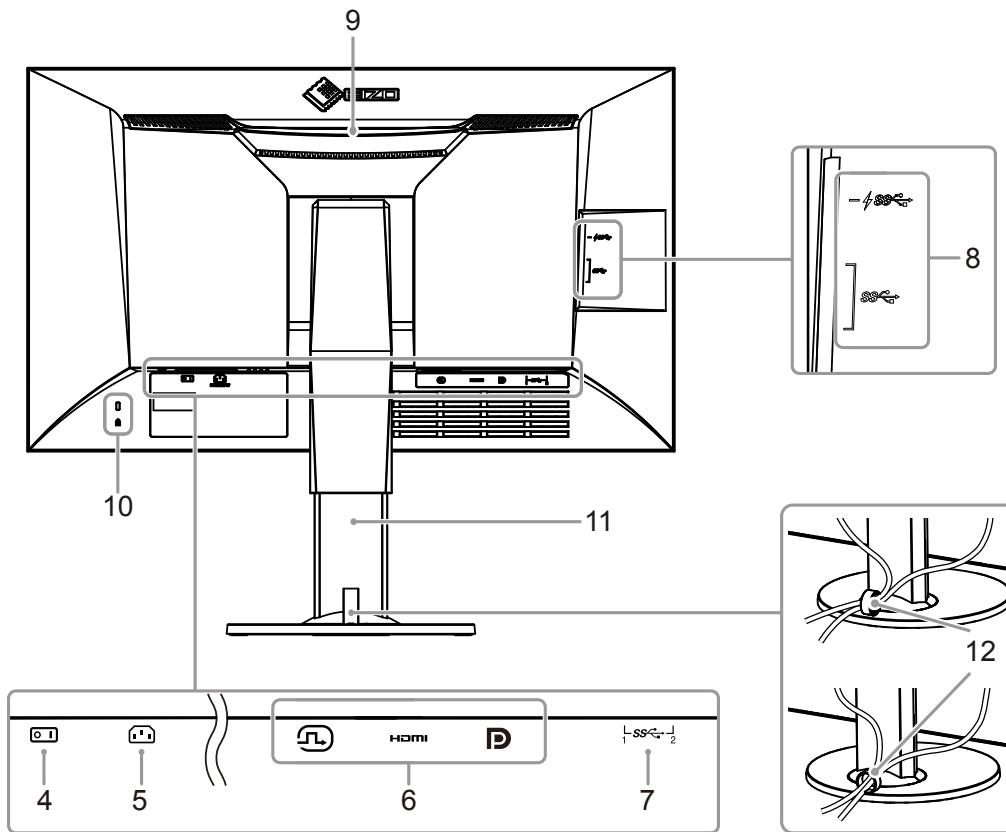

4. Main power switch	Turns the main power on or off. : On ○: Off
5. Power connector	Connects the power cord.
6. Input signal connectors	Left: DVI-D connector Center: HDMI connector Right: DisplayPort connector
7. USB upstream port	Connects to the USB cable when using software that requires a USB connection, or when using the USB Hub function (page 44).
8. USB downstream port	Connects to a peripheral USB device. The ⚡ icon port supports quick recharging (page 30).
9. Handle	This handle is used for transportation. Attention <ul style="list-style-type: none"> Firmly grasp and hold the monitor by the bottom while grabbing the handle, and carefully convey the monitor so as not to drop it. Do not hold the sensor section on the front side of the monitor.
10. Security lock slot	Complies with Kensington's MicroSaver security system.
11. Stand^{*2}	Adjusts the height and angle (tilt and swivel) of the monitor. Attention <ul style="list-style-type: none"> When adjusting the height or angle, do not hold the sensor section on the front side of the monitor.
12. Cable holder^{*3}	Covers the monitor cables.

^{*2} An optional arm (or an optional stand) can be attached by removing the stand section (see "6-1. Removing the Stand" (page 39)).

^{*3} For details on mounting the cable holder, see "6-3. Attaching/Detaching the Cable Holder" (page 42).

1-3. Compatible Resolutions

The monitor supports the following resolutions.

● DVI

Resolution	Dot clock	Horizontal scanning frequency	Vertical scanning frequency	DVI (Dual Link ^{*1})	DVI (Single Link ^{*1})
640 x 480	25.175 MHz	31.469 kHz	59.940 Hz	√	√
640 x 480	25.200 MHz	31.500 kHz	60.000 Hz	√ ^{*3}	√ ^{*3}
720 x 400	28.322 MHz	31.469 kHz	70.087 Hz	√	√
800 x 600	40.000 MHz	37.879 kHz	60.317 Hz	√	√
1024 x 768	65.000 MHz	48.363 kHz	60.004 Hz	√	√
1280 x 720p	74.250 MHz	37.500 kHz	50.000 Hz	√ ^{*3}	√ ^{*3}
1280 x 720p	74.250 MHz	45.000 kHz	60.000 Hz	√ ^{*3}	√ ^{*3}
1280 x 960	108.000 MHz	60.000 kHz	60.000 Hz	√	√
1280 x 1024	108.000 MHz	63.981 kHz	60.020 Hz	√	√
1600 x 1200	162.000 MHz	75.000 kHz	60.000 Hz	√	√
1680 x 1050	119.000 MHz	64.674 kHz	59.883 Hz	√ ^{*3}	√ ^{*3}
1680 x 1050	146.250 MHz	65.290 kHz	59.954 Hz	√ ^{*3}	√ ^{*3}
1920 x 1080	138.500 MHz	66.587 kHz	59.934 Hz	√	√
1920 x 1080p	74.250 MHz	27.000 kHz	24.000 Hz	√ ^{*3}	√ ^{*3}
1920 x 1080p	74.250 MHz	28.125 kHz	25.000 Hz	√ ^{*3}	√ ^{*3}
1920 x 1080p	74.250 MHz	33.750 kHz	30.000 Hz	√ ^{*3}	√ ^{*3}
1920 x 1080p	148.500 MHz	56.250 kHz	50.000 Hz	√ ^{*3}	√ ^{*3}
1920 x 1080p	148.500 MHz	67.500 kHz	60.000 Hz	√	√
1920 x 1200	154.000 MHz	74.038 kHz	59.950 Hz	√	√
2048 x 1080	74.250 MHz	27.000 kHz	24.000 Hz	√ ^{*3}	√ ^{*3}
2560 x 1440 ^{*2}	146.250 MHz	43.945 kHz	29.935 Hz	-	√
2560 x 1440 ^{*2}	241.500 MHz	88.787 kHz	59.951 Hz	√	-

*1 "Signal Format" (page 34) must be set.

*2 Recommended resolution

*3 The output device must be defined. Refer to the User's Manual of the output device for further details.

● DisplayPort

Resolution	Dot clock	Horizontal scanning frequency	Vertical scanning frequency	DisplayPort
640 x 480	25.175 MHz	31.469 kHz	59.940 Hz	√
640 x 480	25.200 MHz	31.500 kHz	60.000 Hz	√*2
720 x 400	28.322 MHz	31.469 kHz	70.087 Hz	√
720 x 480p (4:3)	27.027 MHz	31.500 kHz	60.000 Hz	√*2
720 x 480p (16:9)	27.027 MHz	31.500 kHz	60.000 Hz	√*2
800 x 600	40.000 MHz	37.879 kHz	60.317 Hz	√
1024 x 768	65.000 MHz	48.363 kHz	60.004 Hz	√
1280 x 720p	74.250 MHz	37.500 kHz	50.000 Hz	√*2
1280 x 720p	74.250 MHz	45.000 kHz	60.000 Hz	√*2
1280 x 960	108.000 MHz	60.000 kHz	60.000 Hz	√
1280 x 1024	108.000 MHz	63.981 kHz	60.020 Hz	√
1600 x 1200	162.000 MHz	75.000 kHz	60.000 Hz	√
1680 x 1050	119.000 MHz	64.674 kHz	59.883 Hz	√*2
1680 x 1050	146.250 MHz	65.290 kHz	59.954 Hz	√*2
1920 x 1080	138.500 MHz	66.587 kHz	59.934 Hz	√
1920 x 1080p	74.250 MHz	27.000 kHz	24.000 Hz	√*2
1920 x 1080p	74.250 MHz	28.125 kHz	25.000 Hz	√*2
1920 x 1080p	74.250 MHz	33.750 kHz	30.000 Hz	√*2
1920 x 1080p	148.500 MHz	56.250 kHz	50.000 Hz	√*2
1920 x 1080p	148.500 MHz	67.500 kHz	60.000 Hz	√
1920 x 1200	154.000 MHz	74.038 kHz	59.950 Hz	√
2048 x 1080	74.250 MHz	27.000 kHz	24.000 Hz	√*2
2560 x 1440*1	146.250 MHz	43.945 kHz	29.935 Hz	√*2
2560 x 1440*1	241.500 MHz	88.787 kHz	59.951 Hz	√

*1 Recommended resolution

*2 The output device must be defined. Refer to the User's Manual of the output device for further details.

● HDMI

Resolution	Dot clock	Horizontal scanning frequency	Vertical scanning frequency	HDMI
640 x 480	25.175 MHz	31.469 kHz	59.940 Hz	√
640 x 480	25.200 MHz	31.500 kHz	60.000 Hz	√
720 x 400	28.322 MHz	31.469 kHz	70.087 Hz	√
720 (1440) × 480i (4:3)	27.027 MHz	15.750 kHz	60.000 Hz	√
720 (1440) × 480i (16:9)	27.027 MHz	15.750 kHz	60.000 Hz	√
720 x 480p (4:3)	27.027 MHz	31.500 kHz	60.000 Hz	√
720 x 480p (16:9)	27.027 MHz	31.500 kHz	60.000 Hz	√
720 (1440) × 576i (4:3)	27.000 MHz	15.625 kHz	50.000 Hz	√
720 (1440) × 576i (16:9)	27.000 MHz	15.625 kHz	50.000 Hz	√
720 x 576p (4:3)	27.000 MHz	31.250 kHz	50.000 Hz	√
720 x 576p (16:9)	27.000 MHz	31.250 kHz	50.000 Hz	√
800 x 600	40.000 MHz	37.879 kHz	60.317 Hz	√
1024 x 768	65.000 MHz	48.363 kHz	60.004 Hz	√
1280 x 720p	74.250 MHz	37.500 kHz	50.000 Hz	√
1280 x 720p	74.250 MHz	45.000 kHz	60.000 Hz	√
1280 x 960	108.000 MHz	60.000 kHz	60.000 Hz	√
1280 x 1024	108.000 MHz	63.981 kHz	60.020 Hz	√
1600 x 1200	162.000 MHz	75.000 kHz	60.000 Hz	√
1680 x 1050	119.000 MHz	64.674 kHz	59.883 Hz	√*2
1680 x 1050	146.250 MHz	65.290 kHz	59.954 Hz	√*2
1920 x 1080	138.500 MHz	66.587 kHz	59.934 Hz	√
1920 x 1080i	74.250 MHz	28.125 kHz	50.000 Hz	√
1920 x 1080i	74.250 MHz	33.750 kHz	60.000 Hz	√
1920 x 1080p	74.250 MHz	27.000 kHz	24.000 Hz	√
1920 x 1080p	74.250 MHz	28.125 kHz	25.000 Hz	√
1920 x 1080p	74.250 MHz	33.750 kHz	30.000 Hz	√
1920 x 1080p	148.500 MHz	56.250 kHz	50.000 Hz	√
1920 x 1080p	148.500 MHz	67.500 kHz	60.000 Hz	√
1920 x 1200	154.000 MHz	74.038 kHz	59.950 Hz	√
2560 x 1440*1	146.250 MHz	43.945 kHz	29.935 Hz	√
2560 x 1440*1	241.500 MHz	88.787 kHz	59.951 Hz	√

*1 Recommended resolution

*2 The output device must be defined. Refer to the User's Manual of the output device for further details.

1-4. Changing the PC Display Settings

If the screen is not properly displayed after connecting the monitor to a PC, follow the procedure below to change the PC display settings.

● Windows 10

1. Right-click anywhere on the desktop except for on icons to display the menu.
2. From the displayed menu, click “Display settings” to display the “Settings” screen.
3. If there are multiple monitors including the notebook PC screen connected to the computer, select “Extend these displays” from the “Multiple displays” menu, and click “Keep changes” in the confirmation screen. After changing the settings, select the monitor from the “Select and arrange display” menu.
4. By checking the option “Make this my main display” from the “Multiple displays” menu, the display of the monitor will be corrected.
5. Confirm that the monitor’s recommended resolution is set in the “Resolution” menu (the term (Recommended) should be displayed after the resolution).
6. To change the size of letters and icons, select the preferred magnification level from the scaling (%) menu.
7. When after changing these settings a message is displayed that prompts you to sign out, sign out once and then sign in again.

● Windows 8.1 / Windows 7

* For Windows 8.1, click the “Desktop” tile on the Start Screen to display the desktop.

1. Right-click anywhere on the desktop except for on icons to display the menu.
2. From the displayed menu, click “Screen resolution” to display the settings screen.
3. If there are multiple monitors including the notebook PC screen connected to the computer, select “Extend these displays” from the “Multiple displays” menu, and click “Apply”. In the confirmation screen, click “Keep changes”.
4. Select the monitor from the “Display” menu, check the option “Make this my main display”, and click “Apply”. The display of the monitor will be corrected.
5. Confirm that the monitor’s recommended resolution is set in the “Resolution” menu (the term (Recommended) should be displayed after the resolution).
6. To change the size of letters and icons, click “Make text and other items larger or smaller”, select the preferred size from the settings screen, and click “Apply”.
7. When after changing settings a message is displayed that prompts you to sign out or log off, sign out or log off once and then sign in or log on again.

● macOS

1. Select “System Preferences” from the Apple menu.
2. When the “System Preferences” panel is displayed, click “Displays”.
3. If there are multiple monitors including the notebook PC screen connected to the computer, open the “Arrangement” tab and confirm that “Mirror displays” is not selected. If it is selected, clear it.
4. Select the “Display” tab, and confirm that “Default for display” of “Resolution” is selected. If it is not selected, select it. This sets the correct resolution. Close the “System Preferences” menu. If there are multiple monitors including the notebook PC screen connected to the computer, change the settings for each monitor by using “Display”.
5. To select a different resolution, select “Scaled”, select a resolution from the resolution list (displayed in list or icon format), and close the panel.

Chapter 2 Basic Adjustments/Settings

This chapter describes the basic functions that can be adjusted and set by touching the switches on the front of the monitor.

For advanced adjustment and setting procedures using the Setting menu, see “Chapter 3 Advanced Adjustments/Settings” (page 17).

2-1. Switch Operation Method

1. Displaying the operation guide

1. Touch any switch (except ).
- The operation guide appears on the screen.

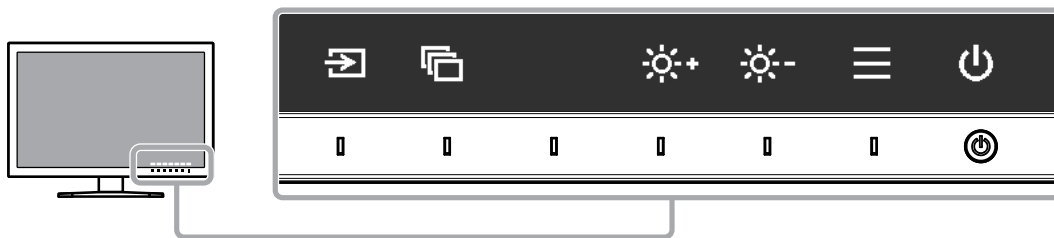

2. Adjusting/setting

1. Touch a switch for adjustment/setting.
The Adjustment/Setting menu appears.
2. Use the switches to adjust/set the selected item, and then select  to confirm.

3. Exiting

1. Select  to exit the menu.
2. When no menu is displayed, the operation guide will automatically disappear after a few seconds if no switches are operated.

Note

- The contents of the guide will differ depending on the selected menu or status.

2-2. Switching Input Signals

When a monitor has multiple signal inputs, the signal to display on-screen can be changed. When the input signal is switched, the connector name of the displayed signal appears at the bottom right of the screen.

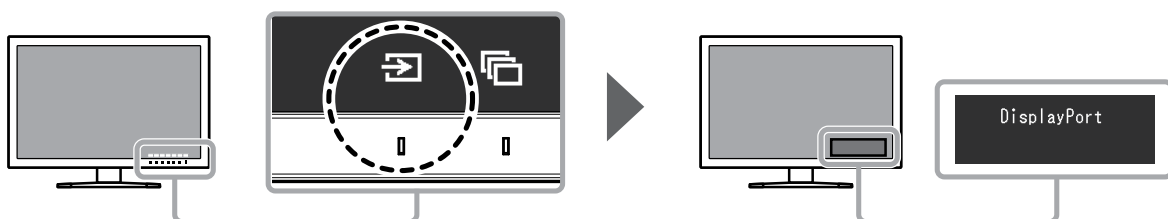

2-3. Switching the Display Mode (color mode)

This function allows easy selection of a display mode according to monitor application.

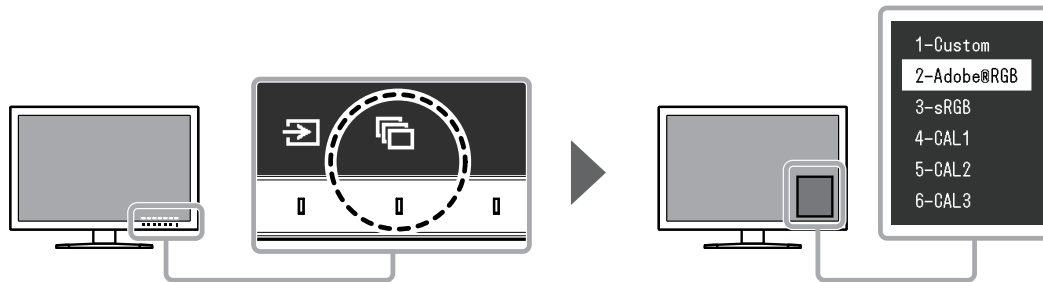

● Display Modes

Color Mode	Purpose
Standard Mode	Adjust color using the Color Management Software "ColorNavigator 7" or the monitor's Setting menu.
Custom	Select for configuring color settings according to your preference.
Adobe®RGB	Suitable for color matching with Adobe®RGB compatible peripherals.
sRGB	Suitable for color matching with sRGB compatible peripherals.
Advanced Mode (CAL mode)	Adjusts the monitor's color using the monitor's SelfCalibration function or the "ColorNavigator 7" color management software.
CAL1	Displays the screen adjusted by ColorNavigator 7 and SelfCalibration.
CAL2	
CAL3	

Note

- The Setting menu and the Mode names cannot be displayed at the same time.
- You can disable specific mode selections. For more information, see "Mode Skip" (page 30).
- In the default settings, available Advanced Mode (CAL modes) differ depending on each input signal.
 - CAL1: DVI
 - CAL2: DisplayPort
 - CAL3: HDMI

2-4. Adjusting the Brightness

The brightness of the screen can be adjusted to suit the installation environment or personal preference.

Adjustable Range

40 cd/m² to 400 cd/m²

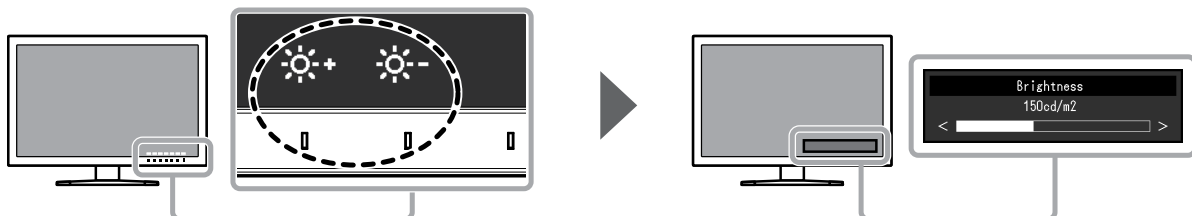

Chapter 3 Advanced Adjustments/Settings

This chapter describes the advanced monitor adjustment and setting procedures using the Setting menu. For the basic adjustment/setting functions using the switches on the front of the monitor, see “Chapter 2 Basic Adjustments/Settings” (page 15).

3-1. Basic Operation of the Setting Menu

1. Menu display

1. Touch any switch (except ⏻).
The operation guide appears.
2. Select ☰ .
The Setting menu appears.



2. Adjusting/setting

1. Choose a menu to adjust/set with ⬆ ⬇ , and then select ☑ .
The Sub menu appears.

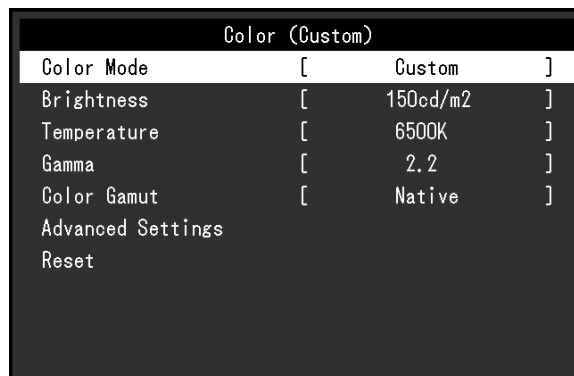



2. Choose an item to adjust/set with ⬆ ⬇ , and then press ☑ .
The Adjustment/Setting menu appears.



3. Adjust/set the selected item with ⬅ ➡ , and then select ☑ .
The Sub menu appears.

Selecting ✕ during adjustment/setting will cancel the adjustment/setting and restore the state prior to making changes.

3. Exiting

1. Select .
The Setting menu appears.
2. Select .
The Setting menu exits.

Note

- The contents of the guide will differ depending on the selected menu or status.
-

3-2. Setting Menu Functions

● Color

The setting details differ depending on the color mode selected.

When the color mode is Standard Mode (Custom / Adobe®RGB / sRGB)

Each color mode setting status can be adjusted according to personal preference.



Attention

- The same image may be seen in different colors on multiple monitors due to differences between individual monitors. Make fine color adjustment visually when matching colors on multiple monitors.

Note

- Use the values shown in "cd/m²", "K" and "%" as a guide only.

Function	Adjustable Range	Description
Color Mode	Custom Adobe®RGB sRGB CAL1 CAL2 CAL3	Switch to the desired mode according to the monitor application. Note <ul style="list-style-type: none"> • For more information on how to switch modes, see “2-3. Switching the Display Mode (color mode)” (page 16). • Regarding "CAL1 / CAL2 / CAL3" see page 22.
Brightness	40 cd/m ² to 400 cd/m ²	The screen brightness is adjusted by changing the brightness of the backlight (light source from the LCD back panel). Note <ul style="list-style-type: none"> • If the entered value cannot be set, the value will appear in magenta. In such a case, change the value.
Temperature	Native 4000 K to 10000 K Adobe®RGB sRGB	The color temperature can be adjusted. The color temperature is used to express the hue of "White" or "Black" by a numerical value. The value is expressed in degrees "K" (Kelvin). The screen becomes reddish at a low color temperature, and bluish at a high color temperature, like the temperature of a flame. Specify a color temperature in units of 100 K, or select a standard name. Note <ul style="list-style-type: none"> • When you select "Native", the original color of the monitor (Gain: 100 % for each RGB) is displayed. • "Gain" allows you to perform more advanced adjustment. When gain is changed, the color temperature is changed to "User". • The gain preset values are set for each color temperature setting value.

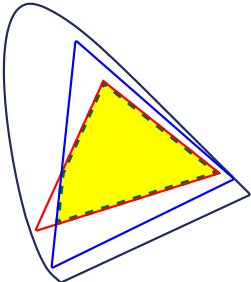
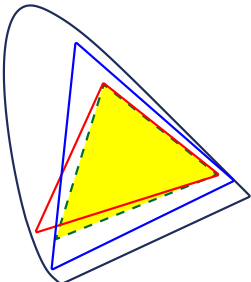
Function		Adjustable Range	Description
Gamma		1.6 to 2.7 Adobe®RGB sRGB	<p>Adjust the gamma.</p> <p>The brightness of the monitor varies depending on the input signal, however, the variation rate is not simply proportional to the input signal. The control performed to keep the balance between the input signal and the brightness of the monitor is called “Gamma correction”.</p> <p>Set the gamma, or select a standard name.</p>
Color Gamut		Native Adobe®RGB sRGB	<p>Set the color reproduction area (color gamut).</p> <p>“Color Gamut” is the range of colors that devices such as monitors, digital cameras and printers can represent. Multiple standards are defined.</p> <p>Note</p> <ul style="list-style-type: none"> • Select “Native”, to display the original color gamut of the monitor. • The method of displaying colors outside the monitor’s displayable range within the defined color gamut can be set. For more information, see “Clipping” (page 20).
Advanced Settings	Hue	-100 to 100	<p>Adjust the hue.</p> <p>Note</p> <ul style="list-style-type: none"> • Using this function may make some color gradations unavailable for display.
	Saturation	-100 to 100	<p>Adjust the color saturation.</p> <p>Note</p> <ul style="list-style-type: none"> • Using this function may make some color gradations unavailable for display. • The minimum value (-100) changes the screen to monochrome.
	Clipping	On Off	<p>The method of displaying colors outside the monitor's displayable range within the color gamut specified in accordance with “Color Gamut” (page 20) can be set.</p> <ul style="list-style-type: none"> • “On” The range of colors that are displayable on the monitor will be accurately displayed in accordance with the standard. Colors outside the displayable range will be saturated.  <ul style="list-style-type: none"> • “Off” Displays colors with priority on the color gradation rather than the color accuracy. The vertices of the color gamut defined in the standard move to a range that can be displayed by the monitor. This allows the closest colors displayable by the monitor to be displayed.  <p> — Color gamut displayable by the monitor — Color gamut defined by standard - - - Color gamut displayed on screen </p> <p>Note</p> <ul style="list-style-type: none"> • The diagrams shown above are conceptual diagrams, and they do not display the actual color gamut of the monitor. • This setting will be disabled if “Native” is selected at “Color Gamut” (page 20).

Function		Adjustable Range	Description
Advanced Settings	Gain	0 % to 100 %	The brightness of each color component red, green, and blue is called Gain. The hue of "white" can be changed by adjusting the gain. Note <ul style="list-style-type: none"> • Using this function may make some color gradations unavailable for display. • The gain value changes according to the color temperature. • When gain is changed, the color temperature is changed to "User".
	6 Colors	-100 to 100	The hue, saturation and lightness can each be adjusted for the colors Magenta, Red, Yellow, Green, Cyan, and Blue.
Reset		-	Resets any color adjustments for the currently selected color mode back to the default settings.

When the color mode is Advanced Mode (CAL mode: CAL1 / CAL2 / CAL3)

You can set the calibration targets, and check the calibration results, for SelfCalibration. SelfCalibration is a function that automatically operates a calibration sensor built in to the monitor to periodically calibrate the monitor. For more information, see [“SelfCalibration” \(page 24\)](#).



Function		Adjustable Range	Description
Color Mode		Custom Adobe®RGB sRGB CAL1 CAL2 CAL3	Switch to the desired mode according to the monitor application. Note <ul style="list-style-type: none"> For more information on how to switch modes, see “2-3. Switching the Display Mode (color mode)” (page 16). Before setting the calibration targets for SelfCalibration, select the color mode (CAL1 / CAL2 / CAL3) to apply to the target. Regarding "Custom / Adobe®RGB / sRGB", see page 19.
SelfCalibration		On Off	Switch between SelfCalibration enabled/disabled for the currently selected color mode. After setting "On", set a SelfCalibration target in the next "Target".
Target	Brightness	30 cd/m ² to 200 cd/m ²	Set the brightness that will be used as a calibration target for SelfCalibration.
	White Point	White(x) White(y)	0.2400 to 0.4500 Set the White Point that will be used as a calibration target for SelfCalibration.
		Temperature	4000 K to 10000 K Adobe®RGB sRGB

Function		Adjustable Range	Description
Target	Color Gamut	Native Adobe®RGB sRGB	Set the color gamut that will be used as a calibration target for SelfCalibration.
	Gamut Settings	Red(x) Red(y) Green(x) Green(y) Blue(x) Blue(y)	0.0000 to 1.0000 In "Color Gamut", the color gamut defined by each standard can be selected. To set a color gamut other than those specified by each standard, specify the color coordinates of each RGB color, and the display method ("Clipping") of colors outside the displayable range of the monitor in "Gamut Settings".
		Clipping	On Off
	Gamma	1.6 to 2.7 Adobe®RGB sRGB L*	Set the gamma that will be used as a calibration target for SelfCalibration. Set the gamma, or select the gamma curve defined by each standard. Note <ul style="list-style-type: none"> • The gamma becomes "Fixed" when adjusting with ColorNavigator 7. • When "L*" is selected, the gamma curve that is defined in CIE1976 as providing perceptually uniform results is applied.
Result	Calibration Result	-	The previous SelfCalibration results can be checked.
	Last Time	-	The previous SelfCalibration execution date is displayed.
	Usage Time	-	The monitor usage time since the previous SelfCalibration is displayed.
Reset		-	Resets any calibration targets for the currently selected color mode back to the default settings.

● SelfCalibration

This product is equipped with a built-in calibration sensor. By setting the calibration targets and execution schedule in advance, the calibration sensor automatically operates and regularly calibrates the monitor. This automatic calibration function is called "SelfCalibration".

The adjustment content of SelfCalibration differs depending on the color mode that is executed.

- Advanced Mode (CAL mode: CAL1 / CAL2 / CAL3):
 - When performing SelfCalibration on the monitor itself, calibrate the monitor to match the set targets.
 - When using ColorNavigator 7, use ColorNavigator 7 and a measurement device to maintain the calibrated state of the monitor.
- Standard Mode (color mode excluding CAL1 / CAL2 / CAL3): the monitor's color reproduction gamut is updated and each display mode in Standard Mode is adjusted as follows:
 - The temperature is adjusted so that it is as close as possible to the specified value.
 - The gamut values are adjusted so that they are close to each specified value.
 - Information on brightness is updated.

You can set the calibration targets and execution schedule in the monitor's Setting menu or in ColorNavigator 7.

In this section, the settings for executing SelfCalibration on the monitor as a standalone unit are explained. For the settings in ColorNavigator 7, refer to the ColorNavigator 7 User's Manual.

Attention

- It is necessary to wait at least 30 minutes after turning on the power, in order to obtain correct measurement results.

Note

- When the main power of the monitor is on, SelfCalibration can also be executed when there are no PC signals being input.
 - Because brightness and chromaticity will change as you use the monitor, it is recommended to calibrate the monitor periodically.
 - The measurement results from the built-in calibration sensor can be correlated with the measurement results from the external measurement device that you want to use as a reference. For details, refer to the ColorNavigator 7 User's Manual.
-

Procedure

Use the following procedure to set up SelfCalibration. The steps differ according to the color mode used for executing SelfCalibration.

Advanced Mode (CAL mode)	Standard Mode
<p>1. In "Color", set the following functions:</p> <ul style="list-style-type: none"> • "Color Mode": Select the color mode to apply for SelfCalibration. • "SelfCalibration": Set to "On". • "Target": Set a calibration target for SelfCalibration. <p>2. In "SelfCalibration", set the following functions:</p> <ul style="list-style-type: none"> • "Settings": Set the calibration schedule and monitor date and time for SelfCalibration. 	<p>1. In "SelfCalibration", set the following functions:</p> <ul style="list-style-type: none"> • "Settings": Set the calibration schedule and monitor date and time for SelfCalibration. • "Standard Mode": Set "SelfCalibration" to "On".





Function			Adjustable Range	Description
Execute			-	SelfCalibration can be executed manually regardless of the schedule. Note <ul style="list-style-type: none"> After selecting "Execute", warming up (after the power to the monitor is switched on, leaving the monitor on for a certain period of time until the display becomes stable) may be executed before the built-in calibration sensor comes out.
Settings	Schedule	Start time	Power Save Immediately Off	Select the timing to execute SelfCalibration upon reaching the time set in the schedule. <ul style="list-style-type: none"> "Power Save" To be executed under any of the following conditions. <ul style="list-style-type: none"> When the monitor is in "Power Save" mode or power is off at the set time. The monitor shifts to the power saving mode or the power is turned off when the time period set in the schedule has elapsed. "Immediately" SelfCalibration is executed immediately at the set time. "Off" SelfCalibration is not executed. Note <ul style="list-style-type: none"> Upon reaching the set time, the power indicator will blink in white (quickly twice).
		Frequency	Daily Weekly Monthly Quarterly Biannually Annually Usage Time	Select the SelfCalibration execution cycle.

Function			Adjustable Range	Description
Settings	Schedule	Timing	Jan/Apr/Jul/Oct Feb/May/Aug/ Nov Mar/Jun/Sep/Dec Jan/Jul Feb/Aug Mar/Sep Apr/Oct May/Nov Jun/Dec Jan to Dec Every 50 hours to Every 500 hours	When the execution cycle is "Quarterly", "Biannually", "Annually", or "Usage Time", select the timing for executing SelfCalibration. The setting range differs depending on the execution cycle setting. <ul style="list-style-type: none"> "Quarterly": Jan/Apr/Jul/Oct, Feb/May/Aug/Nov, Mar/Jun/Sep/Dec "Biannually": Jan/Jul, Feb/Aug, Mar/Sep, Apr/Oct, May/Nov, Jun/Dec "Annually": Jan to Dec "Usage Time": Every 50 hours to Every 500 hours
		Week	1st week to 5th week	When the execution cycle is "Monthly", "Quarterly", "Biannually", or "Annually", select the week for executing SelfCalibration. Note <ul style="list-style-type: none"> When no day has been selected for "Day" in the selected week, the week of execution will be as follows: <ul style="list-style-type: none"> When the selected week is "1st week": 2nd week When the selected week is "5th week": 4th week
		Day	Monday to Sunday	When the execution cycle is "Weekly", "Monthly", "Quarterly", "Biannually", or "Annually", select the day for executing SelfCalibration.
		Time	0:00 to 11:55 PM	When the execution cycle is "Daily", "Weekly", "Monthly", "Quarterly", "Biannually", or "Annually", select the time for executing SelfCalibration.
	Clock Adjustment	-	Set the monitor date and time. Note <ul style="list-style-type: none"> When the clock has not been set, the schedule will not be applied. If the main power supply is disconnected for an extended period of time, the clock may need resetting. When ColorNavigator 7 is started, the date and time are automatically set. For details, refer to the ColorNavigator 7 User's Manual. 	
Standard Mode	SelfCalibration		On Off	Switch between enabling/disabling the SelfCalibration function.
	Result	Last Time	-	The previous SelfCalibration execution date is displayed.
		Usage Time	-	The monitor usage time since the previous SelfCalibration is displayed.

● Signal

The signal settings are used to configure advanced settings for input signals, such as the screen display size and color format.

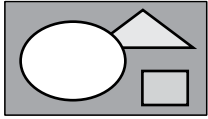
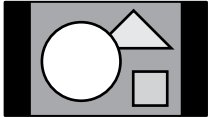
Signal (HDMI)		
Picture Expansion	[Auto]
Input Color Format	[Auto]
Input Range	[Auto]
Noise Reduction	[Off]

Function	Adjustable Range	Description
Picture Expansion	Auto* ¹ Full Screen Aspect Ratio Dot by Dot	<p>The screen size of the monitor display can be changed.</p> <ul style="list-style-type: none"> • "Auto" The monitor automatically changes the screen size according to the resolution information and aspect ratio information from the input signal. • "Full Screen" Displays an image in full screen. Images are distorted in some cases because the vertical rate is not equal to the horizontal rate. • "Aspect Ratio" Displays an image in full screen. However, since aspect ratios are maintained, part of an image may not be visible in horizontal or vertical direction. • "Dot by Dot" Displays the image at the set resolution or at the size specified by the input signal. <p>Note</p> <ul style="list-style-type: none"> • Example settings <ul style="list-style-type: none"> - Full Screen  - Aspect Ratio  - Dot by Dot (Input Signal) 

*1 Only enabled when input signal information according to which the setting can be automatically determined is detected during HDMI input

Function	Adjustable Range	Description
Input Color Format	Auto ^{*2} YUV 4:2:2 ^{*3} YUV 4:4:4 ^{*3} YUV ^{*4} RGB	The color space of the input signal can be specified. Try changing this setting if colors are not displayed correctly. Note • This cannot be configured when DVI input is used. The color space for DVI input is always set to "RGB".

*2 Only enabled when input signal information according to which the setting can be automatically determined is detected

*3 Only enabled during HDMI input

*4 Only enabled during DisplayPort input

Function	Adjustable Range	Description
Input Range	Auto ^{*5} Full Limited (109 % white) Limited	Depending on the external device, the black and white levels in the video signal output to the monitor may be restricted. If the signal is displayed on the monitor in its restricted form, the blacks will be faint, the whites dull, and contrast will be reduced. The brightness range of such signals can be extended to match the actual contrast ratio of the monitor. • "Auto" The monitor automatically recognizes the brightness range of input signals and displays images appropriately. • "Full" The input signal brightness range is not extended. • "Limited (109% white)" The brightness range of the input signal is extended from 16 - 254 (10 bits: 64 - 1019) to 0 - 255 (10 bits: 0 - 1023) for display. • "Limited" The brightness range of the input signal is extended from 16 - 235 (10 bits: 64 - 940) to 0 - 255 (10 bits: 0 - 1023) for display.



*5 Only enabled during DisplayPort input or HDMI input

Function	Adjustable Range	Description
Noise Reduction	On Off	The small noises that occur in dark areas of an image are reduced. Use this function to reduce noise and roughness in images. Note • This can only be set during HDMI input. • Using the Noise Reduction function may lead to deterioration of fine images.

● Preferences

The monitor's settings can be configured to suit the usage environment or personal preference.

Preferences		
Auto Input Detection	[Off]
Menu Rotation	[0°]
USB CHARGE Port	[Normal]
Power Save	[On]
Indicator	[4]
Beep	[On]
Input Skip		
Mode Skip		
USB Selection		
Monitor Reset		

Function	Adjustable Range	Description
Auto Input Detection	On Off	<p>When this function is set to "On", the monitor automatically recognizes the connector through which signals are input, so that the screen can be displayed. When an external device enters the power saving mode, the monitor automatically displays another signal.</p> <p>When set to "Off", the monitor displays the signal from the selected connector regardless of whether a signal is input or not. In this case, select the input signal to display using the operation switch () on the front of the monitor.</p> <p>Note</p> <ul style="list-style-type: none"> • When the main power is turned on/off, the signal is detected automatically regardless of the setting for this function.
Menu Rotation	0° 90°	<p>This function allows you to change the orientation of the Setting menu to align with the installation orientation.</p> <p>Note</p> <ul style="list-style-type: none"> • Be sure that the cables are correctly connected. • When using the monitor screen in a portrait position, the graphics board supporting portrait display is required. When placing the monitor in a portrait position, settings of your graphics board need to be changed. Refer to the User's Manual of the graphics board for details. • When using the monitor in a portrait position, rotate the monitor after pulling up the screen to the uppermost position of the stand and setting the screen tilted upward. 

Function	Adjustable Range	Description
USB CHARGE Port	Normal Charging Only	<p>The ⚡ USB downstream port of the monitor supports USB 3.0 quick charging. By changing this setting to "Charging Only", devices connected to the ⚡ port can be charged more quickly than when using the "Normal" setting.</p> <p>Note</p> <ul style="list-style-type: none"> • Make sure to complete any communication between connected USB devices and the PC before switching this setting. When the setting is switched, all communication will be temporarily interrupted. • Devices that are connected to the ⚡ port must support quick charging. • When "Charging Only" is set, data communications between the PC and connected devices via the ⚡ port are not possible, and therefore, connected devices will not work. • When "Charging Only" is set, charging is possible even when the monitor and PC are not connected by USB cable.
Power Save	On Off	<p>This function allows you to set the monitor to the power saving mode, depending on the state of an external device connected to it.</p> <p>The monitor changes to power saving mode about 15 seconds after signal input ceases to be detected. When the monitor has shifted to power saving mode, images are not displayed on the screen.</p> <ul style="list-style-type: none"> • Exiting power saving mode <ul style="list-style-type: none"> - If the monitor receives input, it automatically exits power saving mode and returns to the normal display mode. <p>Note</p> <ul style="list-style-type: none"> • At the time of shifting to power saving mode, a message that indicates the transition is displayed 5 seconds in advance. • When you are not using the monitor, switch off the main power to cut power consumption. • When the monitor is in power saving mode, devices connected to the USB downstream port will still work. Therefore, power consumption of the monitor varies depending on the connected devices, even in the power saving mode.
Indicator	Off 1 to 7	The brightness of the power switch and the operation switches when the screen is displayed can be set. (Default setting: 4)
Beep	On Off	You can turn off the beep that sounds each time a switch is operated.
Input Skip	Skip -	<p>This function allows skipping of input signals that will not be used when the input signals are switched.</p> <p>Note</p> <ul style="list-style-type: none"> • Not all input signals can be set to "Skip".
Mode Skip	Skip -	<p>This function allows skipping of modes that will not be used when selecting modes. Please use this function if display modes are limited, or if you want to prevent randomly changing the display status.</p> <p>Note</p> <ul style="list-style-type: none"> • Not all modes can be set to "Skip". • In the default settings, available Advanced modes (CAL modes) differ depending on each input signal.

Function	Adjustable Range	Description
USB Selection	USB-1 USB-2	<p>When two PCs are connected to the same monitor, input signals can be associated with the USB upstream port. This enables the USB port to be switched automatically when the input signal is switched. You do not need to change the USB cable connection even when the same monitor is calibrated for the two PCs. Furthermore, you can connect USB devices such as a mouse or keyboard to the monitor, and use these devices from the two PCs.</p> <p>Note</p> <ul style="list-style-type: none"> • A cap is installed on the USB-2 port before the product is shipped. Remove the cap when using the USB-2 port. • In order to use the USB ports by switching from one to the other, two USB cables are required. You need to have one more cable available. • Before changing any settings, remove any USB memory or other storage devices from the monitor. Otherwise, data may be lost or damaged. • The key arrangement of the keyboard cannot be changed. • When the "Auto Input Detection" function is set to "On", the USB port is switched according to the input signal. • The USB downstream port operates for the computer from which images are being displayed.
Monitor Reset	-	<p>Restore all settings to their default values except for the following settings.</p> <ul style="list-style-type: none"> • Settings in the "Administrator Settings" menu • The "Settings" - "Clock Adjustment" item in the "SelfCalibration" menu • The "USB Selection" item in the "Preferences" menu <p>Note</p> <ul style="list-style-type: none"> • Regarding the default setting, see "Main Default Settings" (page 49).

● Languages

The display language for menus and messages can be selected.

Adjustable Range

English, Deutsch, Français, Español, Italiano, Svenska, Japanese, Simplified Chinese, Traditional Chinese



● Information

You can check the monitor information (model name, serial number, firmware version, usage time, ColorNavigator license status, resolution, input signal, etc.).

Example:

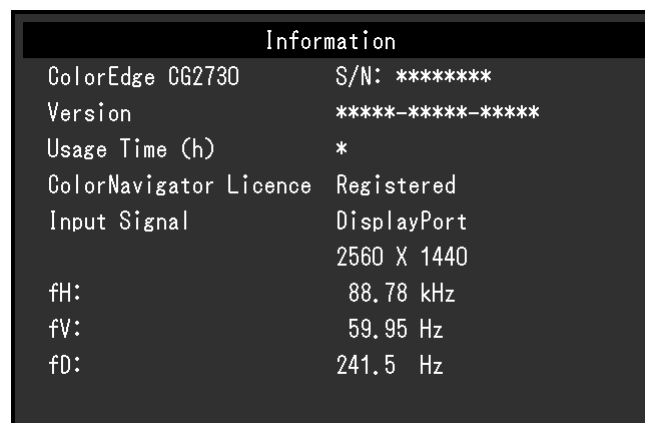



Chapter 4 Administrator Settings

This chapter describes how to configure monitor operation using the "Administrator Settings" menu. This menu is for administrators. Configuration on this menu is not required for normal monitor use.

4-1. Basic Operation of the "Administrator Settings" Menu

1. Menu display

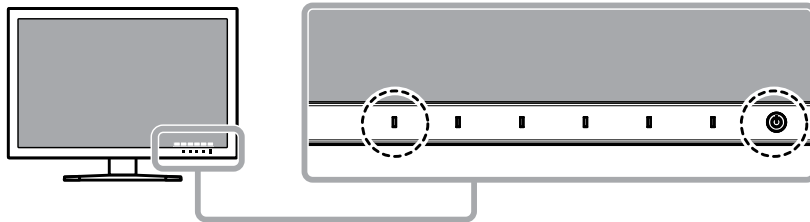

1. Touch  to turn off the monitor.
2. While touching the leftmost switch, touch  for more than 2 seconds to turn on the monitor.



The "Administrator Settings" menu appears.

Administrator Settings		
On-Screen Logo	[On]
Key Lock	[Off]
DP Power Save	[Off]
DUE Priority	[Uniformity]
Signal Format		
Apply		

2. Settings

1. Choose an item to set with  , and then select .
- The Adjustment/Setting menu appears.

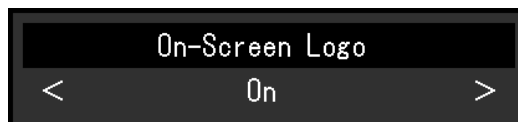

2. Set the item with  , and then select .
- The "Administrator Settings" menu appears.

3. Applying and exiting

1. Select "Apply", and then select .
- The settings are confirmed and the "Administrator Settings" menu quits.



4-2. "Administrator Settings" Menu Functions



Function	Adjustable Range	Description	
On-Screen Logo	On Off	When the monitor is turned on, the EIZO logo appears on the screen. When this function is set to "Off", the EIZO logo does not appear.	
Key Lock	Off Menu All	In order to prevent changes to settings, the operation switches on the front of the monitor can be locked. <ul style="list-style-type: none"> "Off" (Default setting) Enable all switches. "Menu" Lock the  switch. "All" Lock all switches except the power switch. 	
DP Power Save	On Off	When you switch the power back on or return from power save mode while the PC is connected via the DisplayPort connector, windows or icons may have shifted position. In such cases, set this function to "Off".	
DUE Priority	Brightness Uniformity	This product is equipped with a Digital Uniformity Equalizer (DUE) function that reduces display unevenness. This DUE setting can be changed. <ul style="list-style-type: none"> "Brightness" Prioritizes high brightness and high contrast. "Uniformity" Prioritizes reduction of display unevenness. <p>Note</p> <ul style="list-style-type: none"> When changing the DUE setting, the monitor whose display is adjusted must be re-calibrated. Perform the target calibration and correlation again using ColorNavigator 7. For details, refer to the ColorNavigator 7 User's Manual. 	
Signal Format	DVI	Single Link Dual Link	You can switch the signal type that the monitor can display. To display video signals when using HDMI signal input, set to "Video".
	DisplayPort	RGB RGB/YUV	
	HDMI	Video PC	

Chapter 5 Troubleshooting

5-1. No Picture

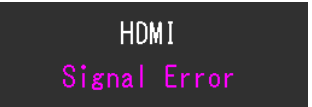
Problem	Possible cause and remedy
1. No picture <ul style="list-style-type: none"> Power indicator does not light up. 	<ul style="list-style-type: none"> Check whether the power cord is connected properly. Turn on the main power switch on the rear side of the monitor. Touch . Turn off the main power on the rear side of the monitor, and then turn it on again a few minutes later.
<ul style="list-style-type: none"> Power indicator is lighting white. 	<ul style="list-style-type: none"> Increase "Brightness" and/or "Gain" in the Setting menu. (See "Color" (page 19))
<ul style="list-style-type: none"> Power indicator is lighting orange. 	<ul style="list-style-type: none"> Switch the input signal. Move the mouse or press any key on the keyboard. Check whether the PC is turned on. Turn off the main power on the rear side of the monitor, and then turn it on again.
<ul style="list-style-type: none"> Power indicator is flashing orange and white. 	<ul style="list-style-type: none"> This problem may occur when a PC is connected via the DisplayPort connector. Connect via the signal cable specified by EIZO, turn off the monitor, and then turn it on again.
2. The message below appears.	This message appears when the signal is not input correctly even though the monitor is functioning properly.
<ul style="list-style-type: none"> This message appears when no signal is input. <p>Example:</p> 	<ul style="list-style-type: none"> The message shown left may appear, because some PCs do not output the signal immediately after power-on. Check whether the PC is turned on. Check whether the signal cable is connected properly. Switch the input signal. Turn off the main power on the rear side of the monitor, and then turn it on again.
<ul style="list-style-type: none"> The message shows that the input signal is out of the frequency specification range. <p>Example:</p> 	<ul style="list-style-type: none"> Check whether the PC is configured to meet the resolution and vertical scan frequency requirements of the monitor (see "1-3. Compatible Resolutions" (page 10)). Reboot the PC. Change to the appropriate setting using the graphics board's utility. Refer to the User's Manual of the graphics board for details.

5-2. Imaging Problems

Problem	Possible cause and remedy
1. The screen is too bright or too dark.	<ul style="list-style-type: none"> • Use "Brightness" in the Setting menu to adjust it. (see "Color" (page 19)). The LCD monitor backlight has a limited life span. If the screen becomes dark or begins to flicker, contact your local EIZO representative.
2. Afterimages appear	<ul style="list-style-type: none"> • Afterimages are particular to LCD monitors. Avoid displaying the same image for a long time. • Use the screen saver or power saving function to avoid displaying the same image for extended periods of time.
3. Green/red/blue/white dots or defective dots remain on the screen.	<ul style="list-style-type: none"> • This is due to LCD panel characteristics and not a malfunction.
4. Interference patterns or pressure marks remain on the screen.	<ul style="list-style-type: none"> • Display a white or black image over the entire screen. The symptom may disappear.
5. Noise appears on the screen.	<ul style="list-style-type: none"> • When inputting HDCP system signals, normal images may not be displayed immediately.
6. (DisplayPort signal input) When you switch the power back on or return from power save mode, windows or icons may have shifted position.	<ul style="list-style-type: none"> • In the Setting menu, set "DP Power Save" to "Off" (see "DP Power Save" (page 34)).
7. (DisplayPort or HDMI input) The screen colors look strange.	<ul style="list-style-type: none"> • Try changing "Input Color Format" in the Setting menu (see "Input Color Format" (page 28)). • For HDMI signal input, try changing "Signal Format" in the Setting menu (see "Signal Format" (page 34)).
8. The image does not display on the entire screen.	<ul style="list-style-type: none"> • Try changing "Picture Expansion" in the Setting menu (see "Picture Expansion" (page 27)). • For HDMI signal input, check whether "Signal Format" is set to "PC" in the Setting menu (see "Signal Format" (page 34)).

5-3. Other Problems

Problem	Possible cause and remedy
<p>1. The Setting menu/Mode menu cannot be displayed</p>	<ul style="list-style-type: none"> • Check whether the operation switch lock function works (see “Key Lock” (page 34)). • Operation switches are locked when the main window of ColorNavigator 7 is displayed. Exit the software.
<p>2. The monitor connected with the USB cable is not detected. / USB device connected to the monitor does not work.</p>	<ul style="list-style-type: none"> • Check whether the USB cable is connected correctly (see “6-5. Making Use of USB (Universal Serial Bus)” (page 44)). • If a peripheral device is connected to the  port, try checking the "USB CHARGE Port" setting (see “USB CHARGE Port” (page 30)). If it is set to "Charging Only", the peripheral device will not work. • Try changing to a different USB port on the PC. • Try changing to a different USB port on the monitor. • Reboot the PC. • If the peripheral devices work correctly when the PC and peripheral devices are connected directly, contact your local EIZO representative. • Check whether the PC and OS are USB compliant. (For USB compliance of the respective devices, consult their manufacturers.) • Depending on the USB 3.0 host controller that you are using, connected USB devices may not be recognized correctly. Update to the latest USB 3.0 driver provided by each manufacturer, or connect the monitor to the USB 2.0 port. • Check the PC's BIOS setting for USB when using Windows. (Refer to the User's Manual of the PC for details.)
<p>3. Audio is not output.</p>	<ul style="list-style-type: none"> • This monitor does not support DisplayPort/HDMI audio signals.

5-4. Built-in Calibration Sensor and SelfCalibration Problems

Problem	Possible cause and remedy
1. The built-in calibration sensor does not come out/stays out.	<ul style="list-style-type: none"> • If the protective sticker is affixed to the built-in calibration sensor, peel it off. • Turn off the main power on the rear side of the monitor, wait for a few minutes before turning the power back on, and then execute SelfCalibration again.
2. SelfCalibration cannot be executed.	<ul style="list-style-type: none"> • Check whether the date and time are set correctly on the monitor (see “Clock Adjustment” (page 26)). • Check whether the execution schedule been set (see “Schedule” (page 25)). • Check whether the calibration targets are set correctly (see “Target” (page 22)). • Set the SelfCalibration target using ColorNavigator 7.
3. SelfCalibration failure	<ul style="list-style-type: none"> • Refer to the error code table. If an error code that does not appear in the error code table is displayed, contact your local EIZO representative.

Error Code Table

Error Code	Possible cause and remedy
0011	<ul style="list-style-type: none"> • Calibration cannot be performed because the target brightness is too low. Increase the target brightness, and then execute SelfCalibration again.
0013	<ul style="list-style-type: none"> • There may be a problem with the target value setting. Recheck the target value of the Color Gamut. • It is possible that measurement could not be performed correctly. <ul style="list-style-type: none"> - Ensure that the built-in calibration sensor is not exposed to strong light such as direct sunlight. - Try executing correlation using ColorNavigator 7.
0014	<ul style="list-style-type: none"> • The target brightness may be too high. Lower the target brightness, and then execute SelfCalibration again. • Calibration may have failed. Ensure that the built-in calibration sensor is not exposed to strong light such as direct sunlight, and then execute SelfCalibration again.
0030	<ul style="list-style-type: none"> • The built-in calibration sensor may have failed. Contact your local EIZO representative.
0034	<ul style="list-style-type: none"> • Measurement failed. Execute SelfCalibration again.
0035	<ul style="list-style-type: none"> • The built-in calibration sensor may have failed. Contact your local EIZO representative.
0036	<ul style="list-style-type: none"> • There may be a problem with the target value setting. Recheck the target value of the Color Gamut. • It is possible that measurement could not be performed correctly. <ul style="list-style-type: none"> - Ensure that the built-in calibration sensor is not exposed to strong light such as direct sunlight. - Try executing correlation using ColorNavigator 7.
0050	<ul style="list-style-type: none"> • The built-in calibration sensor may have failed. Contact your local EIZO representative.
0060 0061	<ul style="list-style-type: none"> • The built-in calibration sensor failed to open/close. • If the protective sticker is affixed to the built-in calibration sensor, peel it off. • Turn off the main power on the rear side of the monitor, wait for a few minutes before turning the power back on, and then execute SelfCalibration again.

Chapter 6 Reference

6-1. Removing the Stand

The stand section of this product can be removed.

Attention

- Do not move the removed stand up and down. Doing so may result in injury or equipment damage.
- The monitor and stand are heavy. Dropping them may result in injury or equipment damage.

1. To prevent damaging the panel surface, lay the monitor with its panel surface facing down on a soft cloth spread on a stable surface.

2. Remove the stand.

Press and hold the lock button (1), firmly grip the stand support, and then slide the stand in the direction of the base of the stand (2).

When the tab that holds the stand in place loosens, remove the stand (3).

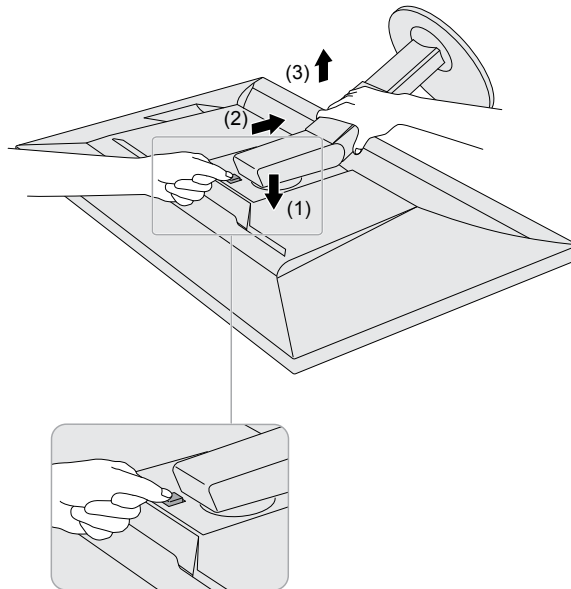

6-2. Attaching the Optional Arm

An optional arm (or an optional stand) can be attached by removing the stand section. Please refer to our web site for the corresponding optional arm (or optional stand). www.eizoglobal.com

Attention

- When attaching an arm or stand, follow the instructions of their User's Manual.
 - When using another manufacturer's arm or stand, confirm the following in advance and select one conforming to the VESA standard. Use the VESA mounting screws supplied with this product when attaching the arm or stand.
 - Clearance between screw holes: 100 mm × 100 mm
 - Outside dimensions of the VESA mount section of the arm or stand: 122 mm × 122 mm or less
 - Plate thickness: 2.6 mm
 - Must be strong enough to support weight of the monitor unit (excluding the stand) and attachments such as cables.
 - When using an arm or stand, attach it to meet the following tilt angles of the monitor.
 - Up 45°, down 45°
 - Connect the cables after attaching an arm or stand.
 - Do not move the removed stand up and down. Doing so may result in injury or equipment damage.
 - The monitor, arm, and stand are heavy. Dropping them may result in injury or equipment damage.
 - When installing the monitor in portrait mode, turn the monitor screen 90° in clockwise direction.
-

Attaching the Optional Arm (or Optional Stand)

1. Attach the arm or stand to the monitor.

Use the VESA mounting screws supplied with this product when attaching the arm or stand.

Attaching the Original Stand

1. To prevent damaging the panel surface, lay the monitor with its panel surface facing down on a soft cloth spread on a stable surface.

2. Remove the fixing screws on the optional arm (or optional stand), and detach the optional arm (or optional stand).

3. Attach the original stand.

Insert the four tabs on the stand into the square holes on the back panel (1) and slide the stand towards the upper portion of the monitor until it makes a clicking sound (2).

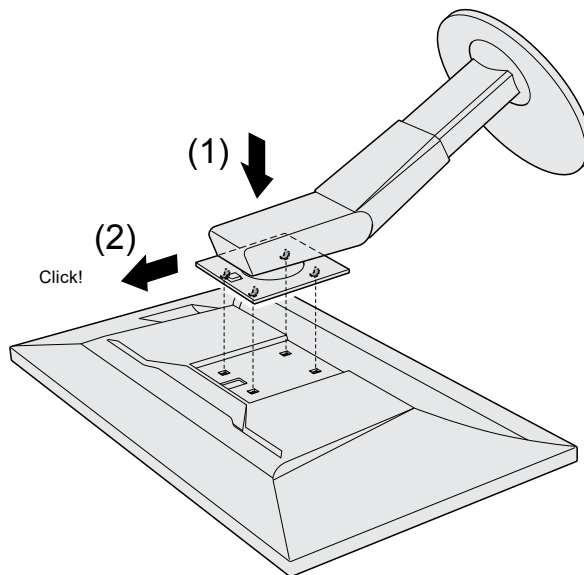

6-3. Attaching/Detaching the Cable Holder

A cable holder is supplied with this product. Use the cable holder to organize the cables connected to the monitor.

Attachment procedure

1. Pass the cables through the cable holder.
2. Close the cable holder.

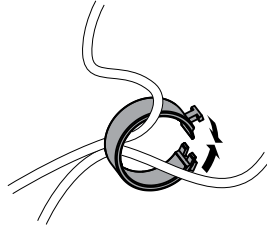

3. While holding the cable holder closed, insert it into the stand.

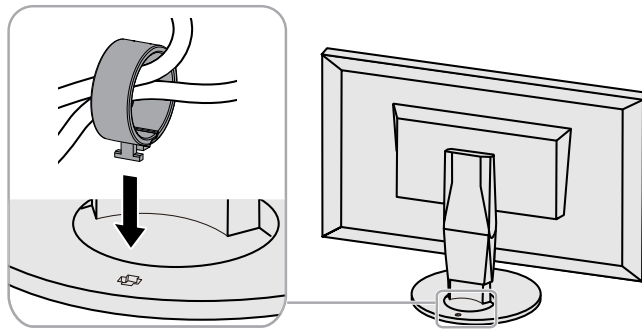

Note

- The cable holder can be inserted either perpendicular or parallel to the stand. Change the orientation of the cable holder in line with the direction of the cables.

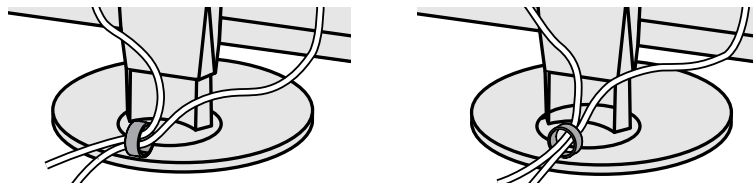

Detachment procedure

1. Close the cable holder.
2. While holding the cable holder closed, pull it from the stand.

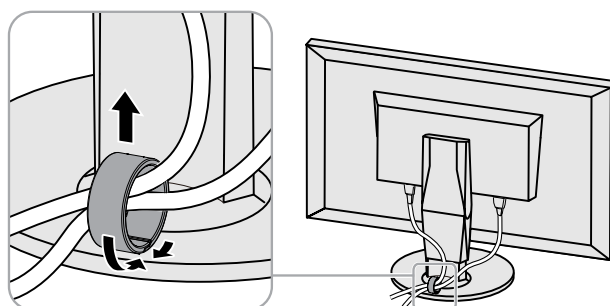

6-4. Connecting Multiple External Devices

The product allows you to connect multiple external devices and switch between them for display.

Connection examples

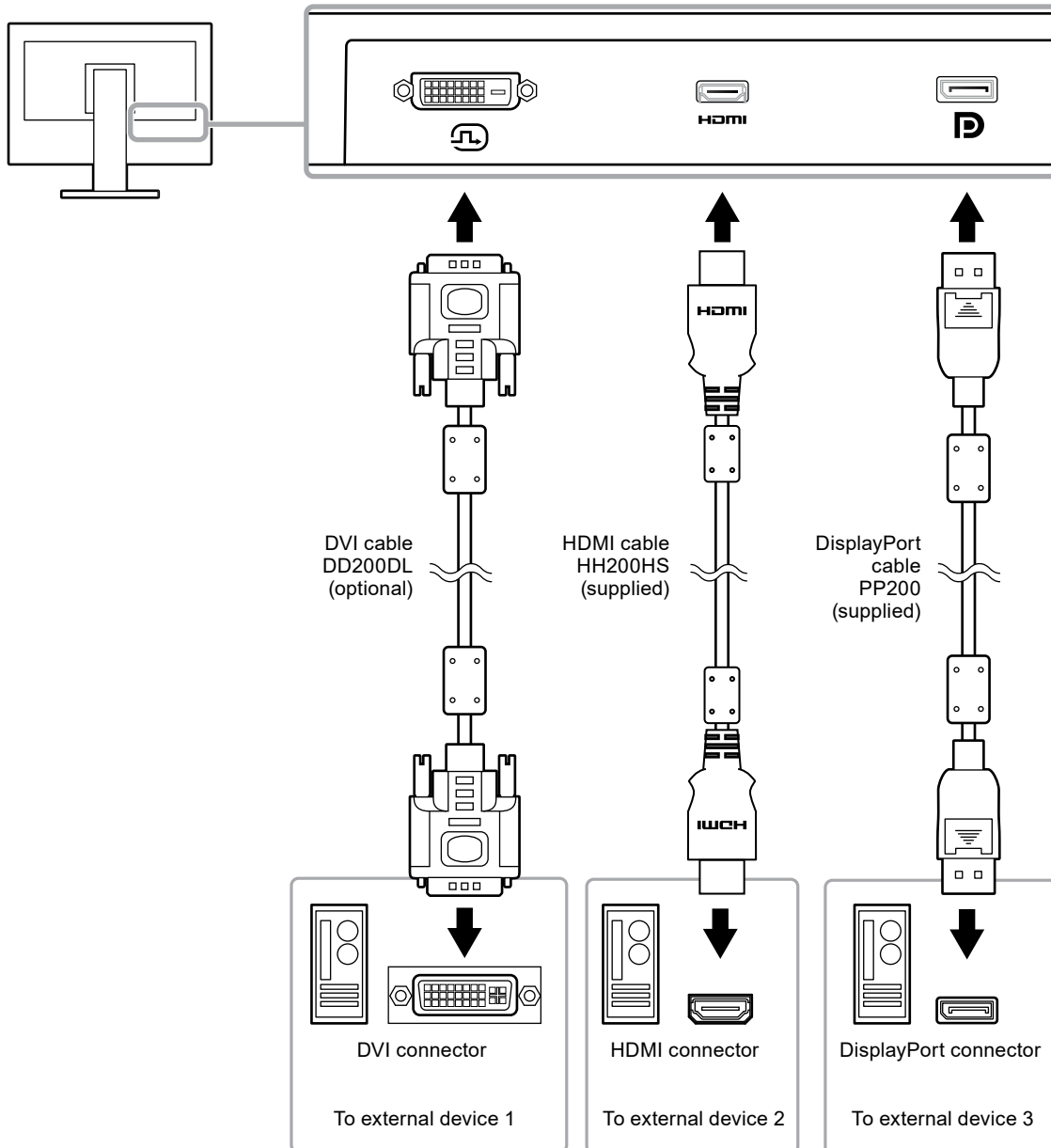

Note

- The input signal changes each time the operation switch () on the front of the monitor is touched. The selected input connector name appears at the bottom right corner of the screen.
- This product automatically recognizes the connector through which signals are input and displays images on the screen accordingly. For more information, see [“Auto Input Detection” \(page 29\)](#).

6-5. Making Use of USB (Universal Serial Bus)

This monitor is equipped with a USB hub. It works as a USB hub when connected to a USB-compatible PC, allowing the connection of peripheral USB devices.

Note

- This product supports USB 3.0. When connecting peripheral devices that support USB 3.0, high-speed data communication is possible (however, only when the USB cable used to connect the PC and peripheral device is USB 3.0 compliant).
- The  USB downstream port also supports quick charging. This allows you to recharge your smartphone or tablet in a short period of time. (See ["USB CHARGE Port" \(page 30\)](#))

● Required System Environment

- A PC equipped with a USB port
- Windows 10 / Windows 8.1 / Windows 7, or Mac OS X 10.7.5 or later
- USB cable (UU200SS (USB 3.0))

Attention

- This monitor may not work depending on the used PC, OS or peripheral devices. For USB compatibility of peripheral devices, contact their manufactures.
- When the monitor is in power saving mode, devices connected to the USB downstream port will still work. Therefore, power consumption of the monitor varies depending on the connected devices, even in the power saving mode.
- When the main power of the monitor is off, a device connected to the USB downstream port will not operate.
- When the "USB CHARGE Port" setting in "Preferences" is set to "Charging Only", a peripheral device will not work if connected to the  port.
- Ensure that communication between all peripheral devices connected to the monitor and the PC is ended before switching the "USB CHARGE Port" setting. When the setting is switched, all communication will be interrupted.

USB upstream

port

● Connection Procedure (Setup of USB Function)

1. Connect the monitor first to a PC using the signal cable, and start the PC.
2. Connect the USB cable between the USB downstream port of the PC and USB upstream port 1 of the monitor.

The USB hub function is set up automatically upon connection of the USB cable.



3. Connect the peripheral USB device to the USB downstream port of the monitor.

Note

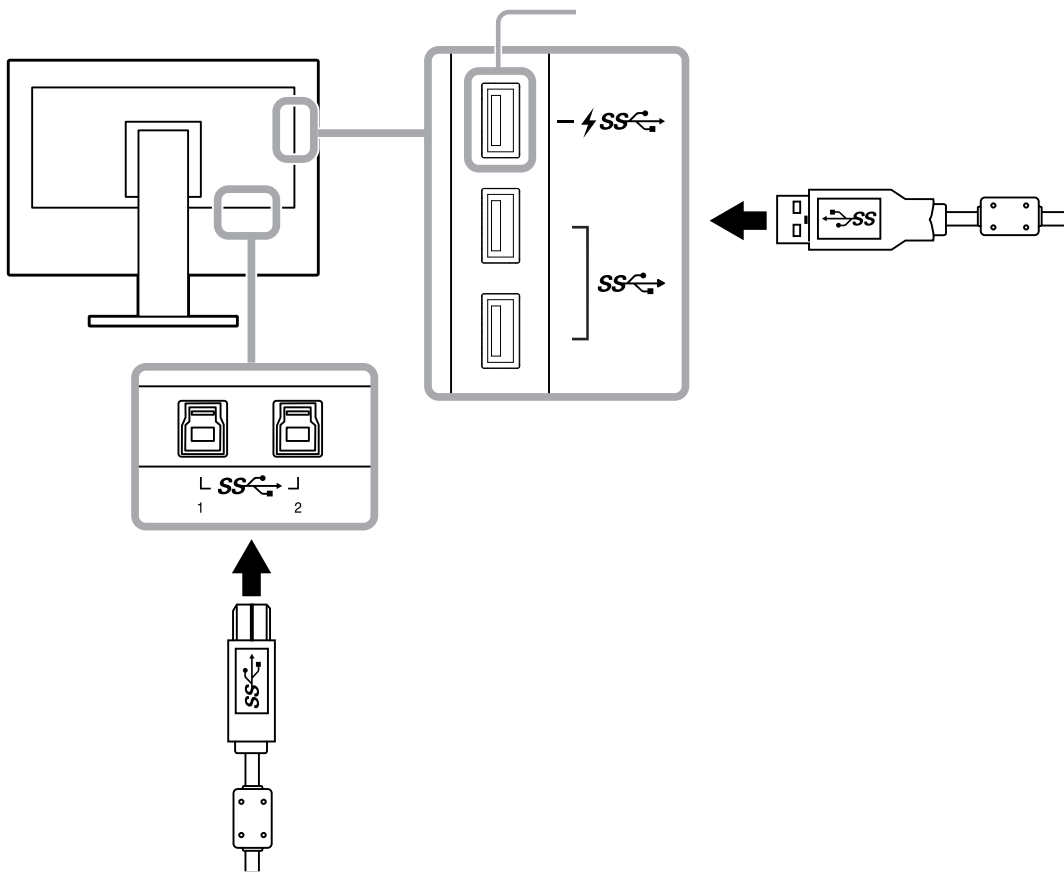
- In the default settings, USB upstream port 1 is enabled. When connecting two PCs, see [“USB Selection”](#) (page 31).
-



6-6. Specifications

LCD Panel	Type	IPS (Anti-Glare)
	Backlight	Wide color gamut LED
	Size	68.5 cm (27.0 inch)
	Resolution	2560 dots × 1440 lines
	Display Size (H × V)	596.7 mm x 335.6 mm
	Pixel Pitch	0.2331 mm x 0.2331 mm
	Display Colors	Approx. 1073.74 million colors (for 10 bit input)
	Viewing Angle (H × V, typical)	178° / 178°
	Recommended Brightness (typical)	120 cd/m ² or less (Temperature: 5000 K to 6500 K)
	Contrast Ratio (typical)	1500 : 1 (When "DUE Priority" setting is "Brightness")
	Response Time (typical)	Black - White - Black: 20 ms Gray-to-gray: 13 ms
	Color Gamut Display (typical)	Adobe®RGB coverage: 99 %, NTSC ratio 108 %
Video Signals	Input Terminals	DVI-D x 1: Supports 8-bit display (Single Link / Dual Link, HDCP-compatible) HDMI x 1: Supports 8-bit, 10-bit, and 12-bit display* ¹ , * ² (HDCP-compatible) DisplayPort x 1: Supports 8-bit and 10-bit display (HDCP-compatible) *1 The maximum number of display bits for HDMI-input images is 10. *2 Supports 8-bit display when the resolution of the HDMI input signal is 2560 x 1440.
	Horizontal scanning frequency	26 kHz to 89 kHz (DVI, DisplayPort), 15 kHz to 89 kHz (HDMI)
	Vertical scan frequency	23 Hz to 61 Hz (For 720 x 400: 69 Hz to 71 Hz)
	Frame Synchronization mode	23.75 Hz to 30.5 Hz, 47.5 Hz to 61.0 Hz
	Dot clock (Max.)	242 MHz
USB	Port	Upstream port x 2, downstream port x 3 (the  port supports quick charging)
	Standard	USB Specification Rev. 3.0 USB Battery Charging Specification Rev.1.2
	Communication Speed	5 Gbps (super), 480 Mbps (high), 12 Mbps (full), 1.5 Mbps (low)
	Supply Current	Downstream : Max. 900 mA per port Downstream ( port) : Normal: Max. 1.5 A per port, Charging Only: Max. 2.1 A per port
Power	Input	100–240 VAC ±10 %, 50/60 Hz 1.0 A–0.45 A
	Maximum Power Consumption	95 W or less
	Power Save Mode	0.6 W or less (When "DP Power Save" is set to "ON", "USB CHARGE Port" is set to "Normal", and no USB device is connected)
	Standby Mode	0.6 W or less (When "DP Power Save" is set to "ON", "USB CHARGE Port" is set to "Normal", and no USB device is connected)

Physical Specifications	Outside Dimensions	Min. height: 638 mm × 404.1 mm × 245 mm (W x H x D) (Tilt: 0°) Max. height: 638 mm × 564.5 mm × 264 mm (W x H x D) (Tilt: 35°)
	Outside Dimensions (Without Stand)	638 mm × 378.2 mm × 64 mm (W x H x D)
	Net. weight	Approx. 8.9 kg
	Net Weight (Without Stand)	Approx. 6.1 kg
	Height adjustment	155 mm (at tilt of 0°) / 145 mm (at tilt of 35°)
	Tilt	Up 35°, down 5°
	Swivel	344°
	Vertical rotation	90° clockwise
Operating Environment Requirements	Temperature	0 °C to 35 °C
	Humidity	20 % to 80 % R.H. (no condensation)
	Air Pressure	540 hPa to 1060 hPa
Transportation/ Storage Environment Requirements	Temperature	-20 °C to 60 °C
	Humidity	10 % to 90 % R.H. (no condensation)
	Air Pressure	200 hPa to 1060 hPa

● Outside Dimensions

Unit: mm

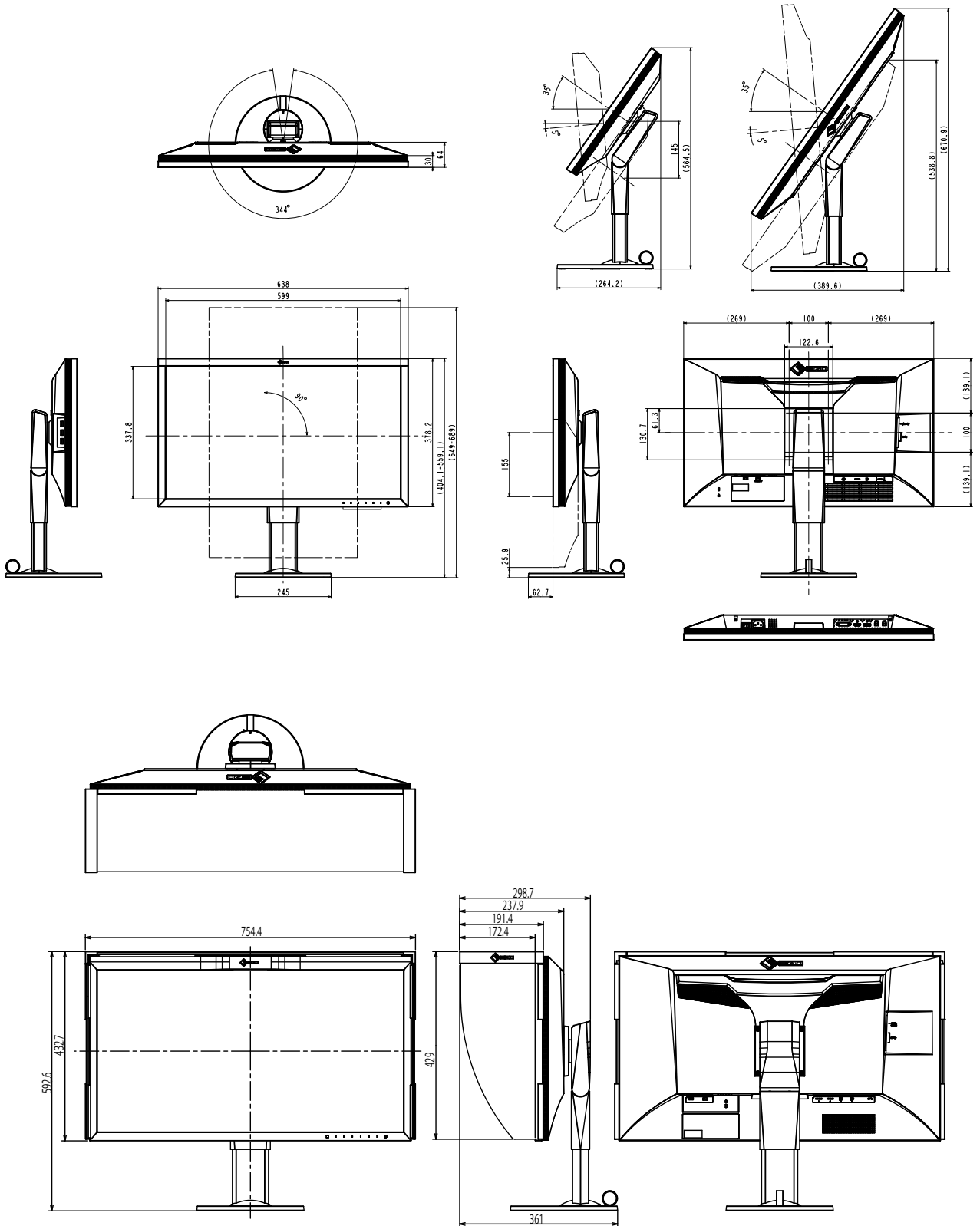

● Main Default Settings

Color Mode		Custom
Picture Expansion	DVI input	Aspect Ratio
	DisplayPort input	Aspect Ratio
	HDMI input	Aspect Ratio (When "Auto" is enabled: Auto)
Input Color Format	DisplayPort input	Auto
	HDMI input	Auto (When "Auto" is disabled: RGB)
Input Range	DVI input	Full
	DisplayPort input	Auto
	HDMI input	Auto
Noise Reduction		Off
Auto Input Detection		Off
Menu Rotation		0°
USB CHARGE Port		Normal
Power Save		On
Indicator		4
Beep		On
Languages		English
On-Screen Logo		On
Key Lock		Off
USB Selection		USB-1
Signal Format	DVI	Dual Link
	DisplayPort	RGB
	HDMI	PC

● Accessories

For the latest information about the accessories, refer to our web site. www.eizoglobal.com

Chapter 7 Glossary

Adobe®RGB

This is a definition of the practical RGB color space proposed by Adobe Systems in 1998. The color reproduction range (color gamut) is broader than sRGB, and is highly adaptable to such fields as printing etc.

Color Space

YUV and RGB, etc. are available. YUV expresses the color by using the luminance (Y), the color difference of Blue (U), and the color difference of Red (V).

RGB does this by using the gradation of the 3 colors, Red (R), Green (G), and Blue (B).

DisplayPort

This is the interface standard for image signals standardized in accordance with VESA. It was developed with the aim of replacing the conventional DVI and analog interfaces, and it can transmit high resolution signals and sound signals, which DVI does not support. The standard size and mini size connectors have been standardized.

DVI (Digital Visual Interface)

DVI is a digital interface standard. DVI allows direct transmission of the PC's digital data without loss.

This adopts the TMDS transmission system and DVI connectors. There are two types of DVI connectors. One is a DVI-D connector for digital signal input only. The other is a DVI-I connector for both digital and analog signal inputs.

Gain

This is used to adjust each color parameter for red, green and blue. An LCD monitor displays the color by the light passing through the panel color filter. Red, green and blue are the three primary colors. All the colors on the screen are displayed by combining these three colors. The color tone can be changed by adjusting the light intensity (volume) passing through each color's filter.

Gamma

Generally, the monitor brightness varies nonlinearly with the input signal level, which is called "Gamma Characteristic". When the gamma value is low, the middle tone area is displayed brighter, and darker when high. Changes to the gamma value will not affect contrast. A gamma value appropriate for the display content should be selected.

HDCP (High-bandwidth Digital Content Protection)

Digital signal coding system developed to copy-protect the digital contents, such as video, music, etc.

This helps to transmit the digital contents safely by coding the digital contents sent via the DVI or HDMI connector on the output side and decoding them on the input side.

Any digital contents cannot be reproduced if both of the equipments on the output and input sides are not applicable to HDCP system.

HDMI (High-Definition Multimedia Interface)

HDMI is a digital interface standard, developed for consumer electrical appliance or AV device. This standard is issued on the basis of the DVI standard which is one of an interface specification for the connection between a PC and a monitor. The projected image, sound and control signal without compressed enable to be transmitted with one cable.

L*

L* is a lightness value based on the CIELUV and CIELAB color spaces. CIELUV and CIELAB are color spaces that describe the relationship between color and human vision, in which L* corresponds to perceived brightness.

Resolution

The LCD panel consists of numerous pixels of specified size, which are illuminated to form images. This monitor consists of horizontal 2560 pixels and 1440 vertical pixels. At a resolution of 2560 × 1440, all pixels are illuminated as a full screen (1:1).

sRGB (Standard RGB)

International standard for color reproduction and color space among peripheral devices (such as monitors, printers, digital cameras, scanners). As a form of simple color matching for the Internet, colors can be displayed using tones close to those of the transmission and reception devices.

Temperature

Color temperature is a method to measure the white color tone, generally indicated in degrees Kelvin. The screen becomes reddish at a low temperature, and bluish at a high temperature, like the flame temperature.

5000 K: Slightly reddish white

6500 K: White referred to as daylight-balanced color

9300 K: Slightly bluish white

Appendix

Trademark

The terms HDMI and HDMI High-Definition Multimedia Interface, and the HDMI Logo are trademarks or registered trademarks of HDMI Licensing, LLC in the United States and other countries.

The DisplayPort Compliance Logo and VESA are registered trademarks of the Video Electronics Standards Association.

The SuperSpeed USB Trident Logo is a registered trademark of USB Implementers Forum, Inc.



The USB Power Delivery Trident Logos are trademarks of USB Implementers Forum, Inc.



DICOM is the registered trademark of the National Electrical Manufacturers Association for its standards publications relating to digital communications of medical information.

Kensington and Microsaver are registered trademarks of ACCO Brands Corporation.

Thunderbolt is a trademark of Intel Corporation in the United States and/or other countries.

Microsoft and Windows are registered trademarks of Microsoft Corporation in the United States and other countries.

Adobe is a registered trademark of Adobe Systems Incorporated in the United States and other countries.

Apple, macOS, Mac OS, OS X, Macintosh and ColorSync are registered trademarks of Apple Inc.

EIZO, the EIZO Logo, ColorEdge, CuratOR, DuraVision, FlexScan, FORIS, RadiCS, RadiForce, RadiNET, Raptor and ScreenManager are registered trademarks of EIZO Corporation in Japan and other countries.

ColorEdge Tablet Controller, ColorNavigator, EcoView NET, EIZO EasyPIX, EIZO Monitor Configurator, EIZO ScreenSlicer, G-Ignition, i•Sound, Quick Color Match, RadiLight, Re/Vue, SafeGuard, Screen Administrator, Screen InStyle, ScreenCleaner and UniColor Pro are trademarks of EIZO Corporation.

All other company and product names are trademarks or registered trademarks of their respective owners.

License

The bitmap font used for this product is designed by Ricoh Industrial Solutions Inc.

FCC Declaration of Conformity

For U.S.A., Canada Only

FCC Declaration of Conformity

We, the Responsible Party

EIZO Inc.

5710 Warland Drive, Cypress, CA 90630

Phone: (562) 431-5011

declare that the product

Trade name: EIZO

Model: ColorEdge CG2730

is in conformity with Part 15 of the FCC Rules. Operation of this product is subject to the following two conditions: (1) this device may not cause harmful interference, and (2) this device must accept any interference received, including interference that may cause undesired operation.

This equipment has been tested and found to comply with the limits for a Class B digital device, pursuant to Part 15 of the FCC Rules. These limits are designed to provide reasonable protection against harmful interference in a residential installation. This equipment generates, uses, and can radiate radio frequency energy and, if not installed and used in accordance with the instructions, may cause harmful interference to radio communications. However, there is no guarantee that interference will not occur in a particular installation. If this equipment does cause harmful interference to radio or television reception, which can be determined by turning the equipment off and on, the user is encouraged to try to correct the interference by one or more of the following measures.

- * Reorient or relocate the receiving antenna.
- * Increase the separation between the equipment and receiver.
- * Connect the equipment into an outlet on a circuit different from that to which the receiver is connected.
- * Consult the dealer or an experienced radio/TV technician for help.

Changes or modifications not expressly approved by the party responsible for compliance could void the user's authority to operate the equipment.

Note

Use the attached specified cable below or EIZO signal cable with this monitor so as to keep interference within the limits of a Class B digital device.

- AC Cord
- Shielded Signal Cable (enclosed)

Canadian Notice

This Class B digital apparatus complies with Canadian ICES-003.

Cet appareil numérique de la classe B est conforme à la norme NMB-003 du Canada.

