

User's Manual

FlexScan® T1501-B T1502-B

Touch Panel Color LCD Monitor

Important

Please read this User's Manual, and the Setup Manual (separate volume) carefully to familiarize yourself with safe and effective usage.

The latest User's Manual is available for download from our web site:

<http://www.eizo.com>

PRECAUTIONS

Notice for this monitor

CONTENTS

Chapter 1 Features and Overview

- 1-1 Features
- 1-2 Buttons and Indicators
- 1-3 Functions and Basic Operation

Chapter 2 Settings and Adjustments

- 2-1 Utility Disk
- 2-2 Screen Adjustment
- 2-3 Color Adjustment
- 2-4 Off Timer Settings
- 2-5 Power Indicator/EIZO Logo Display Settings
- 2-6 Locking Buttons
- 2-7 Setting Adjustment Menu Position
- 2-8 Viewing Information/Setting Language
- 2-9 Setting BrightRegulator
- 2-10 Resumption of Default Setting

Chapter 3 Connecting Cables

- 3-1 Connecting Two PCs to the Monitor

Chapter 4 Troubleshooting

Chapter 5 Reference

- 5-1 Attaching an Arm
- 5-2 Power Saving Mode
- 5-3 Specifications
- 5-4 Glossary
- 5-5 Preset Timing





How to Setup

Please read the Setup Manual (separate volume)



SAFETY SYMBOLS

This manual uses the safety symbols below. They denote critical information. Please read them carefully.

 <p>WARNING Failure to abide by the information in a WARNING may result in serious injury and can be life threatening.</p>	 <p>CAUTION Failure to abide by the information in a CAUTION may result in moderate injury and/or property or product damage.</p>
	<p>Indicates a prohibited action.</p>
	<p>Indicates a mandatory action that must be followed.</p>

No part of this manual may be reproduced, stored in a retrieval system, or transmitted, in any form or by any means, electronic, mechanical, or otherwise, without the prior written permission of EIZO Corporation.

EIZO Corporation is under no obligation to hold any submitted material or information confidential unless prior arrangements are made pursuant to EIZO Corporation’s receipt of said information.

Although every effort has been made to ensure that this manual provides up-to-date information, please note that EIZO monitor specifications are subject to change without notice.

Apple, ColorSync, eMac, iBook, iMac, iPad, Mac, MacBook, Macintosh, Mac OS, PowerBook, and QuickTime are registered trademarks of Apple Inc.

Windows, Windows Media, Windows Vista, SQL Server, and Xbox 360 are registered trademarks of Microsoft Corporation in the United States and other countries.

VESA is a registered trademark of Video Electronics Standards Association.

EIZO, the EIZO Logo, ColorEdge, DuraVision, FlexScan, FORIS, RadiCS, RadiForce, RadiNET, Raptor, and ScreenManager are registered trademarks of EIZO Corporation in Japan and other countries.

All other company and product names are trademarks or registered trademarks of their respective owners.

This product has been adjusted specifically for use in the region to which it was originally shipped. If operated outside this region, the product may not perform as stated in the specifications.

PRECAUTIONS

IMPORTANT

- This product has been adjusted specifically for use in the region to which it was originally shipped. If the product is used outside the region, it may not operate as specified in the specifications.
- To ensure personal safety and proper maintenance, please read carefully this section and the caution statements on the monitor.

[Location of Caution Statement]

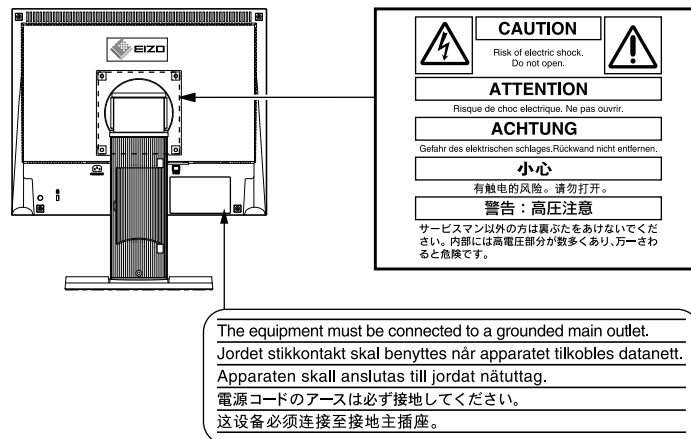

WARNING

If the unit begins to emit smoke, smells like something is burning, or makes strange noises, disconnect all power connections immediately and contact your dealer for advice.

Attempting to use a malfunctioning unit may result in fire, electric shock, or equipment damage.

Do not open the cabinet or modify the unit.

Opening the cabinet or modifying the unit may result in fire, electric shock, or burn.



Refer all servicing to qualified service personnel.

Do not attempt to service this product yourself as opening or removing covers may result in fire, electric shock, or equipment damage.

Keep small objects or liquids away from the unit.

Small objects accidentally falling through the ventilation slots into the cabinet or spillage into the cabinet may result in fire, electric shock, or equipment damage.

If an object or liquid falls/spills into the cabinet, unplug the unit immediately. Have the unit checked by a qualified service engineer before using it again.

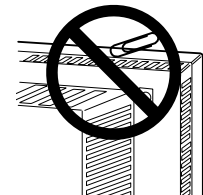

WARNING

Place the unit at the strong and stable place.

A unit placed on an inadequate surface may fall and result in injury or equipment damage. If the unit falls, disconnect the power immediately and ask your dealer for advice. Do not continue using a damaged unit. Using a damaged unit may result in fire or electric shock.

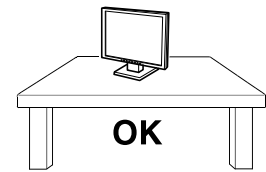

Use the unit in an appropriate location.

Not doing so may result in fire, electric shock, or equipment damage.

- Do not place outdoors.
- Do not place in the transportation system (ship, aircraft, trains, automobiles, etc.)
- Do not place in a dusty or humid environment.
- Do not place in a location where water is splashed on the screen (bathroom, kitchen, etc.).
- Do not place in a location where the steam comes directly on the screen.
- Do not place near heat generating devices or a humidifier.
- Do not place in a location where the product is subject to direct sunlight.
- Do not place in an inflammable gas environment.

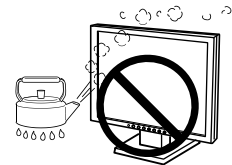

To avoid danger of suffocation, keep the plastic packing bags away from babies and children.

Use the enclosed power cord and connect to the standard power outlet of your country.

Be sure to remain within the rated voltage of the power cord.

Not doing so may result in fire or electric shock.

To disconnect the power cord, grasp the plug firmly and pull.

Tugging on the cord may damage and result in fire or electric shock.



The equipment must be connected to a grounded main outlet.

Failure to do so may result in fire or electric shock.



Use the correct voltage.

- The unit is designed for use with a specific voltage only. Connection to another voltage than specified in this User's Manual may cause fire, electric shock, or equipment damage.
- Do not overload your power circuit, as this may result in fire or electric shock.

Handle the power cord with care.

- Do not place the cord underneath the unit or other heavy objects.
- Do not pull on or tie the cord.

If the power cord becomes damaged, stop using it. Use of a damaged cord may result in fire or electric shock.

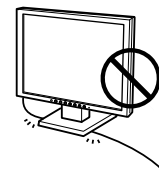

Never touch the plug and power cord if it begins to thunder.

Touching them may result in electric shock.

 **WARNING**

When attaching an arm stand, please refer to the user's manual of the arm stand and install the unit securely.

Not doing so may cause the unit to become unattached, which may result in injury or equipment damage. When the unit is dropped, please ask your dealer for advice. Do not continue using a damaged unit. Using a damaged unit may result in fire or electric shock. When reattaching the tilt stand, please use the same screws and tighten them securely.

Do not touch a damaged LCD panel directly with bare hands.

The liquid crystal that may leak from the panel is poisonous if it enters the eyes or mouth. If any part of the skin or body comes in direct contact with the panel, please wash thoroughly. If some physical symptoms result, please consult your doctor.



Fluorescent backlight lamps contain mercury (the products that have LED backlight lamps contain no mercury), dispose according to local, state or federal laws.

CAUTION

Handle with care when carrying the unit.

Disconnect the power cord and cables when moving the unit. Moving the unit with the cord attached is dangerous. It may result in injury.

When handling the unit, grip the bottom of the unit firmly with both hands ensuring the panel faces outward before lifting.

Dropping the unit may result in injury or equipment damage.

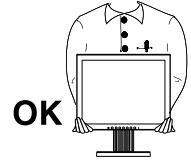

Do not block the ventilation slots on the cabinet.

- Do not place any objects on the ventilation slots.
- Do not install the unit in a closed space.
- Do not use the unit laid down or upside down.

Blocking the ventilation slots prevents proper airflow and may result in fire, electric shock, or equipment damage.

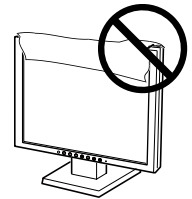

Do not touch the plug with wet hands.

Doing so may result in electrical shock.

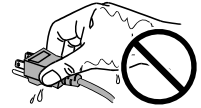

Use an easily accessible power outlet.

This will ensure that you can disconnect the power quickly in case of a problem.

Periodically clean the area around the plug.

Dust, water, or oil on the plug may result in fire.

Unplug the unit before cleaning it.

Cleaning the unit while it is plugged into a power outlet may result in electric shock.

If you plan to leave the unit unused for an extended period, disconnect the power cord from the wall socket after turning off the power switch for the safety and the power conservation.

Notice for this monitor

This product is suited to general purposes like creating documents, viewing multimedia content.

This product may not be covered by warranty for uses other than those described in this manual.

The specifications noted in this manual are only applicable when the following are used:

- Power cords provided with the product
 - Signal cables specified by us
-

Only use optional products manufactured or specified by us with this product.

As it takes about 30 minutes for the performance of electrical parts to stabilize, adjust the monitor 30 minutes or more after the monitor power has been turned on.

Monitors should be set to a lower brightness to reduce changes in luminosity caused by long-term use and maintain stable display.

When the screen image is changed after displaying the same image for extended periods of time, an afterimage may appear. Use the screen saver or power save function to avoid displaying the same image for extended periods of time.

Periodic cleaning is recommended to keep the monitor looking new and to prolong its operation lifetime (refer to [“Cleaning”](#)).

The LCD panel is manufactured using high-precision technology. Although, missing pixels or lit pixels may appear on the LCD panel, this is not a malfunction. Percentage of effective dots: 99.9994% or higher.

The backlight of the LCD panel has a fixed lifetime. When the screen becomes dark or begins to flicker, please contact your local EIZO representative.

Do not scratch or press on the panel with any sharp objects, as this may result in damage to the panel. Do not attempt to brush with tissues as this may scratch the panel.

When the monitor is cold and brought into a room or the room temperature goes up quickly, dew condensation may occur on the interior and exterior surfaces of the monitor. In that case, do not turn the monitor on. Instead wait until the dew condensation disappears, otherwise it may cause some damage to the monitor.

(Cautions for the Use of the Touch Panel)

- During touch operation
 - Be careful of the following points. Otherwise, damage may occur to the monitor.
 - Do not strongly press, scratch, or poke the panel.
 - Do not touch the panel with hard objects such as ballpoint pens or metals.
-
-

Cleaning

Attention

- Chemicals such as alcohol and antiseptic solution may cause gloss variation, tarnishing, and fading of the cabinet or panel, and also quality deterioration of the image.
 - Never use any thinner, benzene, wax, and abrasive cleaner, which may damage the cabinet or panel.
 - Do not allow liquid to enter the clearance between the panel and the panel frame.
-

NOTE

- The optional ScreenCleaner is recommended for cleaning the cabinet and panel surface.
-

If necessary, the stains on the cabinet and panel surface can be removed by moistening part of a soft cloth with water.

To use the monitor comfortably

- An excessively dark or bright screen may affect your eyes. Adjust the brightness of the monitor according to the environmental conditions.
- Staring at the monitor for a long time tires your eyes. Take a 10-minute rest every hour.

CONTENTS

Cover	1	Chapter 5 Reference	24
PRECAUTIONS	1	5-1 Attaching an Arm	24
Notice for this monitor	5	5-2 Power Saving Mode.....	25
Cleaning	6	5-3 Specifications	26
To use the monitor comfortably.....	6	5-4 Glossary	29
CONTENTS	7	5-5 Preset Timing	30
Chapter 1 Features and Overview	8		
1-1 Features	8		
1-2 Buttons and Indicators.....	8		
1-3 Functions and Basic Operation.....	9		
Chapter 2 Settings and Adjustments	11		
2-1 Utility Disk	11		
2-2 Screen Adjustment	12		
Digital Input.....	12		
Analog Input	12		
2-3 Color Adjustment.....	15		
Simple Adjustment [FineContrast Mode]	15		
Advanced Adjustments [Adjustment Menu]	16		
2-4 Off Timer Settings.....	17		
2-5 Power Indicator/EIZO Logo Display Settings..	18		
2-6 Locking Buttons	18		
2-7 Setting Adjustment Menu Position	19		
2-8 Viewing Information/Setting Language	19		
2-9 Setting BrightRegulator	19		
2-10 Resumption of Default Setting	20		
Chapter 3 Connecting Cables	21		
3-1 Connecting Two PCs to the Monitor	21		
Chapter 4 Troubleshooting.....	22		

Chapter 1 Features and Overview

Thank you very much for choosing an EIZO color LCD monitor.

1-1 Features

- Dual-input compliant (DVI-D and D-sub mini 15-pin connectors)
- DVI digital input (TMDS) compliant
- Horizontal scan frequency: Analog: 24.8 - 60 kHz
Digital: 31 - 49 kHz
- Vertical scan frequency: Analog: 55 - 75 Hz
Digital: 59 - 61 Hz (VGA text: 69 - 71 Hz)
- Resolution: 1024 dots × 768 lines
- Stereo speakers
- Smoothing (soft - sharp) function
- BrightRegulator function incorporated
- FineContrast mode to allow the best mode for screen display
- Touch Panel provided
- Touch Panel Pointer “TP1” is available (optional)

1-2 Buttons and Indicators

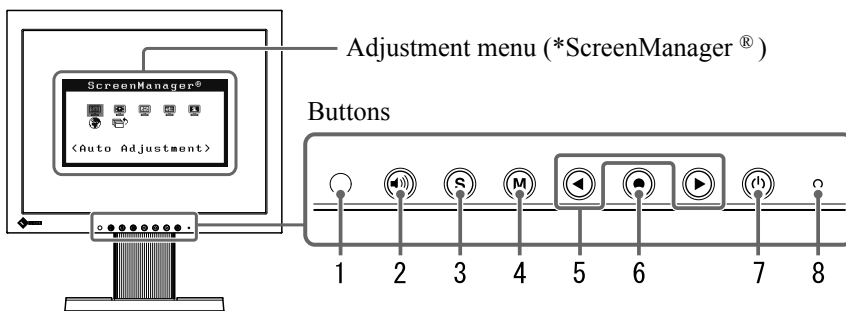

1. Sensor (BrightRegulator)
2. Volume control button
3. Input signal selection button
4. Mode button
5. Control buttons (Left, Right)
6. Enter button
7. Power button
8. Power indicator

Indicator status	Operation status
Blue	The screen is displayed
Orange	Power saving
Off	Power off

* ScreenManager[®] is an EIZO's nickname of the Adjustment menu.

NOTE

- The stand of the unit can be replaced with an arm or another stand. (Refer to “5-1 Attaching an Arm” on page 24.)

NOTE

- While the screen is displayed, the blue power indicator that is lighting blue can be turned off (see “To turn off the Power indicator while a screen is displayed [Power Indicator]” on page 18).
- For the power indicator status with “Off Timer” set, refer to “To set monitor power-off time [Off Timer]” on page 17.

1-3 Functions and Basic Operation

To adjust the screen and color

● Main menu (Refer to page 10 for operation)

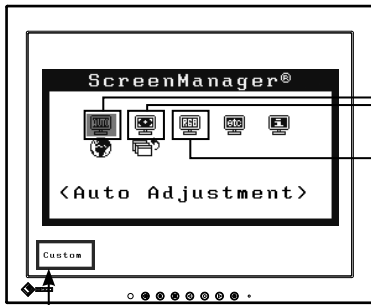

• The Adjustment menu and the FineContrast mode cannot be displayed at the same time.

Ⓜ FineContrast mode

Color Adjustment (Simple adjustment) [FineContrast mode] Page 15

This function allows easy selection of a desired mode from three modes according to monitor application.

```

    graph TD
      Custom[Custom] --> sRGB[sRGB]
      sRGB --> Text[Text]
      Text --> Custom
    
```

Brightness Adjustment
Press ◀ or ▶ to adjust brightness.

Volume Adjustment

1 Press 🔊.

2 Press ◀ or ▶ to adjust volume.

(for analog signal input only)

1 Screen Adjustment (Automatic Adjustment) Page 12

Auto Adjustment

- To adjust flickering and position [Screen] see [page 12](#)
- To adjust color gradation automatically [Range] see [page 14](#)

2 Screen Adjustment (Advanced Adjustment) Page 12

[Adjustment menu]

<p>[At analog signal input]</p> <p><Clock></p>	<p>[At digital signal input]</p> <p><Smoothing></p>
--	---

- To eliminate vertical bars [Clock*] ... see [page 13](#)
- To remove flickering or blurring [Phase*] see [page 13](#)
- To correct screen position [Hor. Position*] see [page 13](#)
- [Ver. Position*] see [page 13](#)
- To modify blurred characters/lines [Smoothing] see [page 14](#)

* Items marked with * can be adjusted with analog input.

Color Adjustment (Advanced Adjustment) Page 16

Color (Custom)

- "Brightness," "Contrast," "Temperature," "Gamma," and "Gain" can be set for each mode (Custom/sRGB/Text). Settable functions vary with the display mode.

Resumption of Default Setting

- To reset color adjustment [Reset] ... see [page 20](#)

To make useful settings/adjustments

● Adjustment menu (Refer to below for operation)

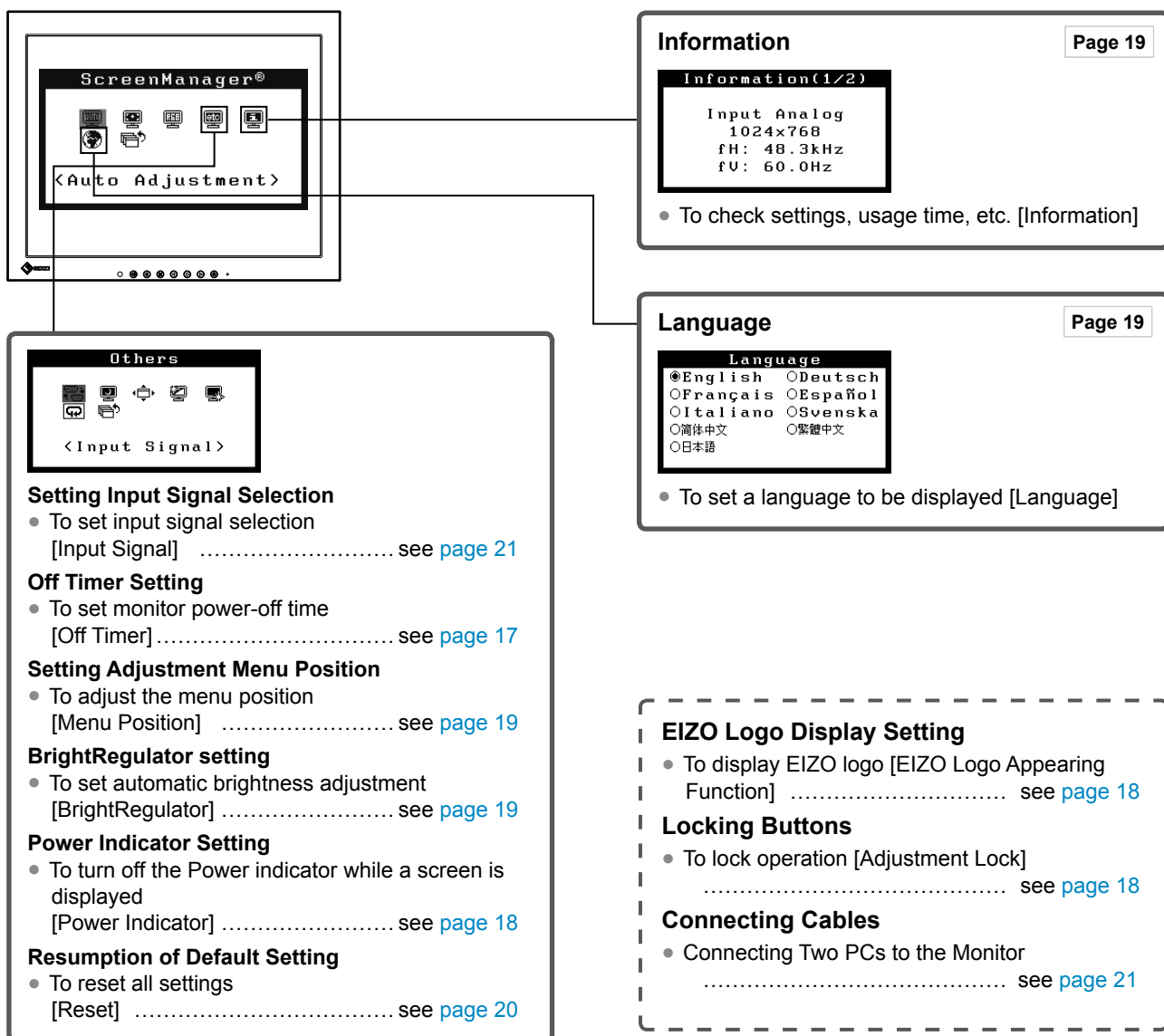

Basic operation of Adjustment menu

[Displaying Adjustment menu and selecting function]

- (1) Press ●. The main menu appears.
- (2) Select a function with ◀ or ▶, and press ●. The sub menu appears.
- (3) Select a function with ◀ or ▶, and press ●. The adjustment/setting menu appears.
- (4) Adjust the selected item with ◀ or ▶, and press ●. The setting is saved.

[Exiting Adjustment menu]

- (1) Choose <Return> from the sub menu and press ●.
- (2) Choose <Exit> from the main menu and press ●.

NOTE

- The Adjustment menu can also be exited by pressing ● twice quickly.

Chapter 2 Settings and Adjustments

2-1 Utility Disk

An “EIZO LCD Utility Disk” (CD-ROM) is supplied with the monitor. The following table shows the disk contents and the overview of the application software programs.

- **Disk contents and software overview**

The disk includes a touch panel driver, an application software program for adjustment, and User's Manual. Refer to “Readme.txt” on the disk for software startup procedures or file access procedures.

Item	Overview	For Windows	For Macintosh
A “Readme.txt” file		√	—
Screen Adjustment Program	Available for easy adjustments of the monitor screen following adjustment patterns and procedures on the screen.	√	—
Touch Panel Driver	Driver for touch panel	√	—
User's Manual of this monitor (PDF file)			
User's Manual for Touch Panel Driver (PDF file)			

2-2 Screen Adjustment

Digital Input

When digital signals are input, images are displayed correctly based on the preset data of the monitor.

Analog Input

The monitor screen adjustment is used to suppress flickering of the screen or adjust screen position and screen size correctly according to the PC to be used. To use the monitor comfortably, adjust the screen when the monitor is set up for the first time or when the settings of the PC in use are updated.





The auto-adjustment function works in the following cases:

- When a signal is input into the monitor for the first time
- When a signal is input into the monitor for the first time after the resolution or refresh rate of input signals is changed

[Adjustment Procedure]

■ Automatic Adjustment

1 To adjust screen automatically [Screen]

- (1) Choose <Screen> from the <Auto Adjustment> menu, and press .
- (2) Select "Execute" with  or , and press .
- (3) Flickering, screen position, and screen size are corrected by the auto-adjustment function.

If satisfactory adjustment cannot be obtained with the auto-adjustment function, perform the adjustment following the procedure below. When the screen is displayed correctly, go to step 4 "Range Adjustment".

■ Advanced Adjustment

2 Run the Screen Adjustment Program.

Load the EIZO LCD Utility Disk on the PC, and start the Screen Adjustment Program.

After the program starts up, perform the adjustment in step 3 following the instructions of the program.

Attention

- Wait 30 minutes or more from monitor power on before starting adjustments.

NOTE

- Use "Screen Adjustment Program" on the supplied EIZO LCD Utility Disk.

Attention

- This function works correctly when an image is fully displayed over the display area. It does not work properly when an image is displayed only on a part of the screen (DOS prompt window, for example) or when a black background (wallpaper, etc.) is in use.
- This function does not work correctly with some graphics boards.
- "Auto in Progress" appears on the screen during auto adjustment.

NOTE

- If no adjustment program is available for your PC, display a checkerboard pattern on the screen (see below) and go to the following steps.

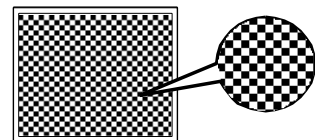

3 Perform advanced adjustments for the following using the <Screen> menu of the Adjustment menu.

- **To eliminate vertical bars [Clock]**

- (1) Choose <Clock> from the <Screen> menu, and press ●. The <Clock> menu appears.
- (2) Adjust the clock with ◀ or ▶, and press ●. The adjustment is completed.

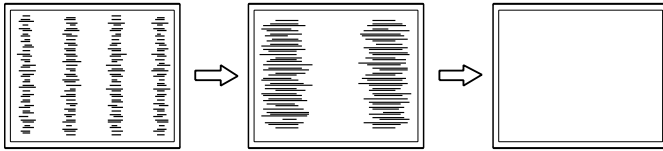

- **To remove flickering or blurring [Phase]**

- (1) Choose <Phase> from the <Screen> menu, and press ●. The <Phase> menu appears.
- (2) Adjust the phase with ◀ or ▶, and press ●. The adjustment is completed.

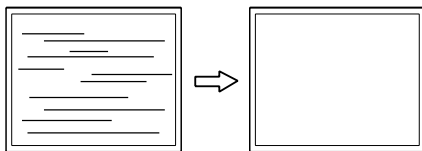

- **To correct screen position [Hor. Position], [Ver. Position]**

Since the number of pixels and the pixel positions are fixed on the LCD monitor, only one position is provided to display images correctly. The position adjustment is made to shift an image to the correct position.

- (1) Choose <Hor. Position> and or <Ver. Position> from the <Screen> menu, and press ●. The <Hor. Position> or <Ver. Position> menu appears.
- (2) Adjust the position with ◀ or ▶ to display the image properly in the display area of the monitor.

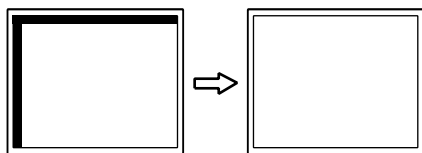

NOTE

- Press the control button slowly so as not to miss the adjustment point.
- When blurring, flickering or bars appear on the screen after adjustment, proceed to [Phase] to remove flickering or blurring.

Attention

- Flickering or blurring may not be eliminated depending on your PC or graphics board.





NOTE

- When vertical bars appear on the screen after adjustment, go back to “To eliminate vertical bars [Clock].” (Clock → Phase → Position)

4 Adjust the signal output range.

- **To adjust color gradation automatically [Range]**

Every color gradation (0 to 255) can be displayed by adjusting the signal output level.





- (1) Choose <Range> from the <Auto Adjustment> menu, and press .
- (2) Select “Execute” with  or , and press .
- (3) Color gradation is adjusted correctly by the auto-adjustment function.
The output range is adjusted automatically.

When using the “Screen Adjustment Program”, the program is finished.

5 Change the smoothing setting.

- **To modify blurred characters/lines [Smoothing]**

When a low-resolution image is displayed, the characters or lines of the displayed image may be blurred.

- (1) Choose <Smoothing> from the <Screen> menu, and press .
The <Smoothing> menu appears.
- (2) Select a suitable level from 1 to 5 (where 1 = soft and 5 = sharp) with  or , and press .
The smoothing adjustment is completed.

2-3 Color Adjustment

Simple Adjustment [FineContrast Mode]

This function allows you to select the best display mode for monitor brightness, etc.

- **FineContrast mode**

An appropriate display mode is selectable out of three modes.

Mode	Purpose
Custom	Available for making desired setting.
sRGB	Suitable for color matching with sRGB compatible peripherals.
Text	Suitable for displaying texts for word processing or spreadsheets.

FineContrast mode name
Example) Custom



- **To select FineContrast mode**

(1) Press **(M)**.

The FineContrast mode changes at every time pressing **(M)**.

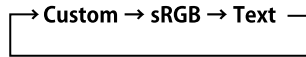

(2) Choose desired mode and press **(●)**.

The setting completes.

NOTE







- The Adjustment menu and the FineContrast mode cannot be displayed at the same time.







Advanced Adjustments [Adjustment Menu]

Independent setting and saving of color adjustment are available for each FineContrast mode.

• To select an appropriate mode for images

√: Adjustment available -: Invalid for adjustment

Icon	Function	FineContrast mode		
		Custom	sRGB	Text
	Brightness	√	√	√
	Contrast	√	-	√
	Temperature	√	-	√
	Gamma	√	-	√
	Gain	√	-	-
	Reset	√	√	√

Menu	Description	Adjustment range
Brightness 	To adjust the full screen brightness as desired NOTE • You can also adjust the brightness by pressing ◀ or ▶ button while the adjustment menu is not displayed. • Press ● after adjustment.	0 to 100%
Contrast 	To adjust the contrast of the image	0 to 100%
Temperature 	To select a color temperature NOTE • Setting the value to “Off” presents the natural color of the panel. • The values shown in the Kelvin (K) are available only as reference.	4000K to 10000K in units of 500K (including 9300K).
Gamma 	To set a gamma value	1.8, 2.0, 2.2
Gain 	To adjust red, green, and blue to a desired color tone respectively NOTE • Values shown in percentage are available only as reference. • When using the <Gain> setting, the <Temperature> setting is set to “Off”.	0 to 100% Adjust the respective brightness of red/green/blue to make a desired color tone. Display an image with white or gray background for adjustment.
Reset 	To reset the color settings of the selected FineContrast mode to the default settings	

• To set/adjust color

- Choose <Color> from the Adjustment menu, and press ●.
- Select a desired function from the <Color> menu, and press ●.
The selected function menu appears.
- Adjust the selected item with ◀ or ▶, and press ●.
The adjustment is completed.

Attention

- Perform [Range Adjustment] before starting color adjustment for analog input signals.
Refer to “To adjust color gradation automatically” on page 14.
- Wait 30 minutes or more from monitor power on before starting the color adjustment.
- Choose “Reset” in the <Color> menu to revert to the default settings (factory settings) of hue of the color mode selected.
- The same image may be seen in different colors on multiple monitors due to their monitor-specific characteristics. Make fine color adjustment visually when matching colors on multiple monitors.

NOTE

- The Adjustment menu and the FineContrast mode cannot be displayed at the same time.
- Adjustable functions vary depending on the type of FineContrast mode.

2-4 Off Timer Settings

• To set monitor power-off time [Off Timer]









This function allows the monitor to automatically turn off after a specified time has passed. This function serves to reduce afterimages caused when the monitor screen is left on for a long time period without use. Use this function when an image is displayed throughout the day.

[Off Timer System]

Timer	Monitor	Power Indicator
ON time (1H - 23H)	Operating	Blue
Last 15 min. in "ON time"	Advance Notice*	Flashing blue
"ON time" expired	Power Off	Off

* When  is pressed during the advance notice period, the monitor continues to operate for additional 90 minutes. Extension of operation time can be set without limitation.

[Procedure]

- (1) Choose <Others> from the Adjustment menu, and press .
- (2) Choose <Off Timer> from the <Others> menu, and press .
The <Off Timer> menu appears.
- (3) Select "Enable" with  or , and press .
- (4) Set a monitor ON time (1 to 23 hours) with  or , and press .
The Off Timer setting is completed.

[Resumption Procedure]

- Press .





Attention

- The Off Timer functions even in the power saving mode, but the advance notice is disabled. The monitor power is turned off without advance notice.

2-5 Power Indicator/EIZO Logo Display Settings



• To turn off the Power indicator while a screen is displayed [Power Indicator]

This function enables to turn off the Power indicator (blue) while a screen is displayed.

- (1) Choose <Others> from the Adjustment menu, and press .
- (2) Choose <Power Indicator> from the <Others> menu, and press .
The <Power Indicator> menu appears.
- (3) Select "Disable" with  or , and press .
The Power Indicator setting is completed.

• To display EIZO logo [EIZO Logo Appearing Function]







When this unit is turned on, the EIZO logo appears at the center of the screen. Selection to display or not to display the logo is available with this function.



- (1) Press  to turn off the unit.
- (2) Press  again while pressing  to turn on the unit.
The EIZO Logo display/non-display function is toggled.

2-6 Locking Buttons



• To lock operation [Adjustment Lock]

This function locks the buttons to retain the status adjusted or set once.

Buttons that can be locked	<ul style="list-style-type: none"> •  (Enter button) Adjustments/settings using Adjustment menu
Buttons that cannot be locked	<ul style="list-style-type: none"> •  /  (Control buttons) •  (Volume control button) •  (Input Signal Selection button) •  (Mode button) •  (Power button)

- (1) Press  to turn off the unit.
- (2) Press  again while pressing .
The screen is displayed with the adjustment lock.

[Unlocking]

- (1) Press  to turn off the unit.
- (2) Press  again while pressing .
The screen is displayed with the adjustment lock released.

NOTE

- The Power indicator lights up at power on with the default setting.





NOTE

- The logo appears with the default setting.

2-7 Setting Adjustment Menu Position

• To adjust the menu position [Menu Position]



Adjust the menu position using the following procedure.

- (1) Choose <Others> from the Adjustment menu, and press .
- (2) Choose <Menu Position> from the <Others> menu, and press .
The <Menu Position> menu appears.
- (3) Select a menu position with  or , and press .
The menu position setting is completed.

2-8 Viewing Information/Setting Language

• To check settings, usage time, etc. [Information]

This function allows you to check settings, model name, serial number, and usage time of the monitor.





- (1) Choose <Information> from the Adjustment menu, and press .
The <Information> menu appears.
- (2) Then, press  to check settings, etc.

• To set a language to be displayed [Language]

Select the Adjustment menu language.

Selectable languages





English/German/French/Spanish/Italian/Swedish/Simplified Chinese/
Traditional Chinese/Japanese

- (1) Choose <Language> menu from the Adjustment menu, and press .
The <Language> menu appears.
- (2) Choose a language with  or , and press .
The language setting is completed.

2-9 Setting BrightRegulator

• To set automatic brightness adjustment [BrightRegulator]

The sensor on the front side of the monitor detects the environmental brightness to adjust the screen brightness automatically and comfortably.

- (1) Choose <Others> from the Adjustment menu, and press .
- (2) Choose < BrightRegulator> from the <Others> menu, and press .
The BrightRegulator setting window appears.
- (3) Select “Enable” or “Disable” with  or , and press .
The BrightRegulator setting is completed.

NOTE

- Five positions (center/ upper right/ lower right/ upper left/ lower left) can be selected.





NOTE

- The usage time is not always “0” when you purchase the monitor due to factory inspection.

2-10 Resumption of Default Setting





• To reset color adjustment [Reset]

The hue in the color mode currently set will revert to the default settings (factory settings).

- (1) Choose <Color> from the Adjustment menu, and press .
- (2) Choose <Reset> from the <Color> menu and press .
The <Reset> menu appears.
- (3) Select <Reset> with  or , and press .
The reset operation is completed.

• To reset all settings [Reset]

Reset all adjustments/settings to the factory default settings.

- (1) Choose <Others> from the Adjustment menu, and press .
- (2) Choose <Reset> from the <Others> menu, and press .
The <Reset> menu appears.
- (3) Select <Reset> with  or , and press .
The reset operation is completed.

NOTE

- For default settings, refer to “[Main default settings \(factory settings\)](#)” on [page 27](#).

Chapter 3 Connecting Cables

3-1 Connecting Two PCs to the Monitor

Two PCs can be connected to the monitor through the DVI-D and the D-Sub mini 15 pin connector on the back of the monitor.

Connection examples

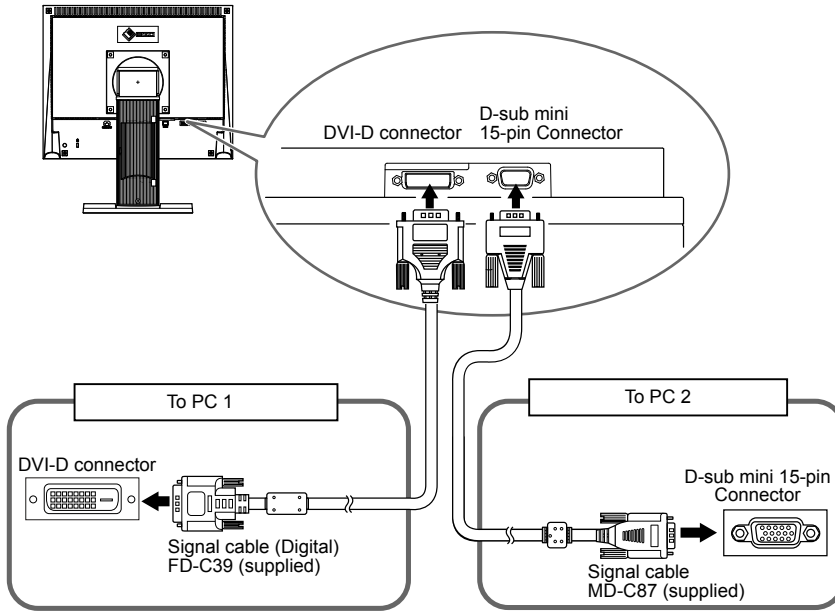

Attention

- The touch panel monitor is designed to use connecting to one PC. If connecting two PCs, connect the touch panel monitor to one PC only (touch operation side) with a USB cable (MD-C93) or RC-232C cable (FD-C38-K).

Selecting input signal

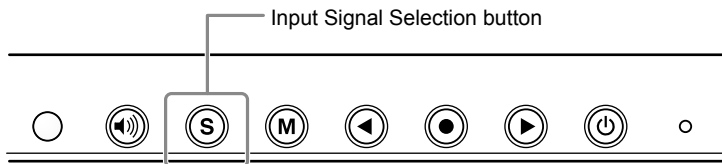

Switch the input signal with **(S)**. Input signal switches each time **(S)** is pressed. When the signal is switched, the active signal type (Analog or Digital) appears at the top right corner of the screen for three seconds.

• To set input signal selection [Input Signal]

Setting	Function
Auto	When PC displayed on the monitor is turned off or enters the power-saving mode, the monitor automatically displays signals of another PC.
Manual	The monitor does not detect the PC's signals automatically. Select an input signal with (S) .







[Procedure]

- Choose <Others> from the Adjustment menu, and press **(●)**.
- Choose <Input Signal> from the <Others> menu, and press **(●)**.
The <Input Signal> menu appears.
- Select "Auto" or "Manual" with **(◀)** or **(▶)**, and press **(●)**.
The Input Priority setting is completed.

Chapter 4 Troubleshooting

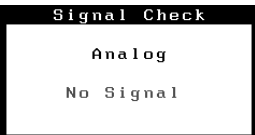
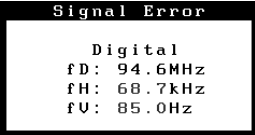
If a problem still remains after applying the suggested remedies, contact your local dealer.

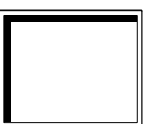
- No-picture problems → See No.1 - No.2.
- Imaging problems → See No.3 - No.11.
- Other problems → See No.12 - No.13.
- Touch panel problems → See No.14 - No.17.

Problems	Possible cause and remedy
<p>1. No picture</p> <ul style="list-style-type: none"> • Power indicator does not light. • Power indicator is lighting blue. • Power indicator is lighting orange. 	<ul style="list-style-type: none"> • Check whether the power cord is connected correctly. • Press . • Set each RGB adjusting value in <Gain> to higher level. (page 16) • Switch the input signal with . • Operate the mouse or keyboard. • Turn on the PC.
<p>2. The message below appears.</p> <ul style="list-style-type: none"> • This message appears when no signal is input.  <ul style="list-style-type: none"> • The message below shows that the input signal is out of the specified frequency range. (Such signal frequency is displayed in red.) Example: 	<p>This message appears when the signal is not input correctly even when the monitor functions properly.</p> <ul style="list-style-type: none"> • The message shown left may appear, because some PCs do not output the signal soon after power-on. • Check whether the PC is turned on. • Check whether the signal cable is connected properly. • Switch the input signal with . • Select an appropriate display mode using the graphics board's utility software. Refer to the manual of the graphics board for details.
<p>3. Display position is incorrect.</p> 	<ul style="list-style-type: none"> • Adjust image position so that it is displayed properly within the display area using the <Hor.Position> and <Ver.Position> adjustment. • If the problem persists, use the graphics board's utility software if available to change the display position.
<p>4. Vertical bars appear on the screen or a part of the image is flickering.</p> 	<ul style="list-style-type: none"> • Adjust using <Clock>.
<p>5. Whole screen is flickering or blurring.</p> 	<ul style="list-style-type: none"> • Adjust using <Phase>.
<p>6. Characters are blurred.</p>	<ul style="list-style-type: none"> • Adjust using <Smoothing>.
<p>7. The screen is too bright or too dark.</p>	<ul style="list-style-type: none"> • Adjust <Brightness>. (The LCD monitor backlight has a fixed life span. When the screen becomes dark or begins to flicker, contact your local dealer.)

Problems	Possible cause and remedy
8. Afterimages appear.	<ul style="list-style-type: none"> • Use a screen saver or off timer function for a long-time image display. • Afterimages are particular to LCD monitors. Avoid displaying the same image for a long time.
9. Green/red/blue/white dots or defective dots remain on the screen.	<ul style="list-style-type: none"> • This is due to LCD panel characteristics and is not a failure.
10. The display image is appeared in lengthwise.	<ul style="list-style-type: none"> • Check whether the kind of cables connected with the monitor and the PC. (Connect the monitor and cables correctly by referring to “Connecting Cables” in Setup Manual (page 3).)
11. The Main menu of Adjustment menu does not start.	<ul style="list-style-type: none"> • Check for Adjustment Lock function. • Check whether the FineContrast menu is running. (Refer to “1-3 Functions and Basic Operation” on page 9.)
12. The auto-adjustment function does not work correctly.	<ul style="list-style-type: none"> • This function does not work when digital signal is input. • This function works correctly when an image is fully displayed over the display area. It does not work properly when an image is displayed only on a part of the screen (DOS prompt window, for example) or when a black background (wallpaper, etc.) is in use. This function does not work correctly with some graphics boards.
13. No audio output	<ul style="list-style-type: none"> • Check whether volume is set to “0”. • Check the settings of the PC and the audio playback software.

Touch panel problems

Problems	Possible cause and remedy
14. Cursor position is not correct. / Cursor jumps.	<ul style="list-style-type: none"> • Turn off and on the monitor. If the symptom is not improved, perform the calibration on the monitor. • Touch with one finger only. • Connect the monitor to the PC with the cable indicated in the Setup Manual or User’s Manual of the monitor. Using a conversion adapter, the touch panel may not operate properly.
15. Touch operation is not effective.	<ul style="list-style-type: none"> • Check whether “Use EEPROM” in the “Device” menu is not checked in the “Properties” settings of the touch panel driver. If the check is already applied, perform the calibration. • Other login user may have changed the setting. Set the touch panel driver again. • Restart “DMC Touch Panel Configuration”, or reboot the PC.
16. Some deflection may appear on the surface of touch panel portion.	<ul style="list-style-type: none"> • Due to the touch panel structural characteristics, the deflection may occur on the touch panel surface in high temperature/high humidity operating environment. This is not a trouble.
17. No touch-sound.	<ul style="list-style-type: none"> • The touch-sound may not be output from the external line out of the PC depending on the hardware configuration. • Under Windows 7, touch-sound is only output through the audio output terminal of the PC. To hear touch-sound, connect speakers.

Chapter 5 Reference

5-1 Attaching an Arm

The stand can be removed and replaced with an arm (or another stand) to be attached to the monitor.

[Attaching]

1 Lay the LCD monitor on a soft cloth spread over on a stable surface with the panel surface facing down.

2 Remove the stand. (Prepare a screwdriver.)

Unscrew the four screws securing the unit and the stand with the screwdriver.

3 Attach the monitor to the arm or stand.

Secure the monitor to the arm or stand using the screws specified in the user's manual of the arm or stand.

- Clearance between the screw holes when attach an arm or stand:
In case of 75mm × 75mm

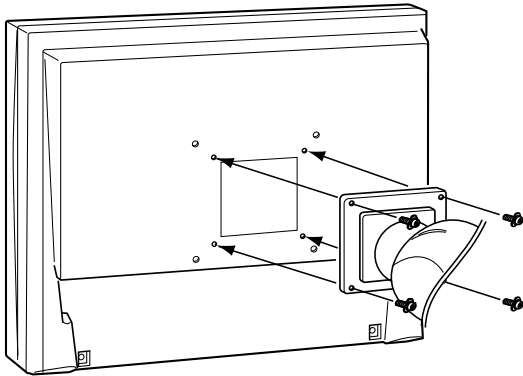

- Clearance between the screw holes when attach an arm or stand:
In case of 100mm × 100mm

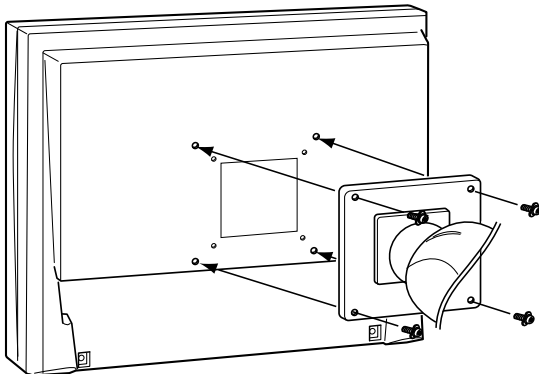

Attention

- When attaching an arm or stand, follow the instructions of their user's manual.
- When using another manufacturer's arm or stand, confirm the following in advance and select one conforming to the VESA standard. Use M4 × 12 mm screws supplied with the monitor.
 - Clearance between the screw holes:
75 mm × 75 mm or
100 mm × 100 mm
 - Thickness of plate: 2.6 mm
 - Strong enough to support weight of the monitor unit (except the stand) and attachments such as cables.
- When using an arm or stand, attach it to meet the following tilt angles of the monitor.
 - Up 45 degrees, down 0 degrees (horizontal display)
- Connect the cables after attaching an arm.

5-2 Power Saving Mode

■ Analog input

This monitor complies with the VESA DPM standard.

[Power Saving System]

PC		Monitor	Power Indicator
Operating		Operating	Blue
Power saving	STAND-BY SUSPENDED OFF	Power saving	Orange

[Resumption Procedure]

- Operate the mouse or keyboard to resume the normal screen.

■ Digital input

This monitor complies with the DVI DMPM standard.

[Power Saving System]

The monitor enters the power saving mode in five seconds in connection with the PC setting.

PC	Monitor	Power Indicator
Operating	Operating	Blue
Power saving	Power saving	Orange

[Resumption Procedure]

- Operate the mouse or keyboard to resume the normal screen.

Attention

- Unplugging the power cord completely shuts off power supply to the monitor.
- Do not setup Standby function for the PC. When the PC is under the standby status, the monitor is not resumed by the touch operation.
- When the monitor is not resumed by the touch operation, operate the mouse or keyboard.

5-3 Specifications

LCD Panel		15-inch (38 cm) TFT color LCD with anti-glare hard coating Viewing angle: Horizontal 160°, Vertical 130° (CR: 10 or more)
Dot Pitch		0.297 mm
Horizontal Scan Frequency		Analog: 24.8 - 60 kHz Digital: 31 - 49 kHz
Vertical Scan Frequency		Analog: 55 - 75 Hz (Non-interlace) Digital: 59 - 61 Hz, (VGA Text: 69 - 71 Hz) (Non-interlace)
Resolution		1024 dots × 768 lines
Max. Dot Clock		Analog: 80 MHz Digital: 65 MHz
Max. Display Colors		Approx. 16.19 million colors
Display Area (H × V)		304.1 mm × 228.1 mm
Touch Panel	OS	Microsoft Windows 7 Service Pack 1 (32 bit/64 bit) Microsoft Windows Vista Service Pack 2 (32 bit) Microsoft Windows XP Service Pack 3 (32 bit) (Not compatible with Mac OS)
	Communication protocol	RS-232C serial (T1501-B)/USB serial (T1502-B)
	Detective method	Analog resistive technology
Power Supply		100 - 120 VAC ±10% 50/60 Hz, 0.5 A 200 - 240 VAC ±10% 50/60 Hz, 0.3 A
Power Consumption		Maximum (usually): 21 W (speaker not working)/25 W (speaker working) Power saving mode: 1 W or less (for single signal input without USB, and no line input connector connected) Power switch Off: 1 W or less
Input Signal Connectors		DVI-D connector, D-sub mini 15-pin connector
Analog Input Signal (Sync)		H/V Separate, TTL, Positive/Negative
Analog Input Signal (Video)		0.7 Vp-p/75 Ω Positive
Digital Signal Transmission System		TMDS (Single Link)
Video Signal Memory		Analog Signal: 18 (preset: 13)
Audio output		Speaker output: 0.5 W + 0.5 W (8 Ω, THD: 10% or less) Headphone output: 2mW + 2mW
Line input		Input impedance 47 kΩ (typ.) Input level: 1.0 Vrms (Max.)
Plug & Play		VESA DDC 2B/EDID structure 1.3
Dimensions (Main unit)		346 mm (W) × 379.5 mm (H) × 175 mm (D) (13.6" (W) × 14.9" (H) × 6.9" (D))
Dimensions (without stand)		346 mm (W) × 280 mm (H) × 69 mm (D) (13.6" (W) × 11.0" (H) × 2.7" (D))
Weight (Main unit)		Approx. 6.1 kg (13.4 lbs)
Weight (without stand)		Approx. 4.1 kg (9.0 lbs)
Environmental Conditions	Temperature	Operating temperature: 0 °C - 35 °C Storage temperature: -20 °C - 60 °C
	Humidity	Operating humidity: 20% - 80% R.H. (no condensation) Storage humidity: 10% - 80% R.H. (no condensation)
	Pressure	Operating: 700 to 1,060 hPa Storage: 200 to 1,060 hPa

Main default settings (factory settings)

BrightRegulator	Disable
Smoothing	3
FineContrast Mode	Custom
Input Signal	Auto
Off Timer	Disable
Language	English

Outside Dimensions

unit : mm (inch)

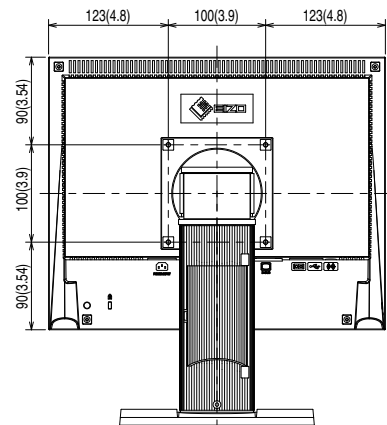
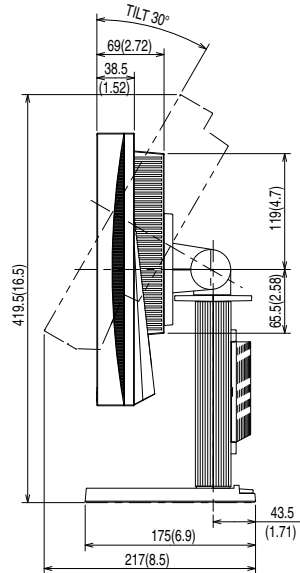
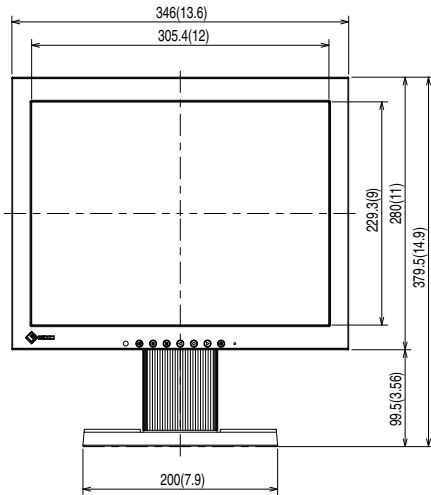
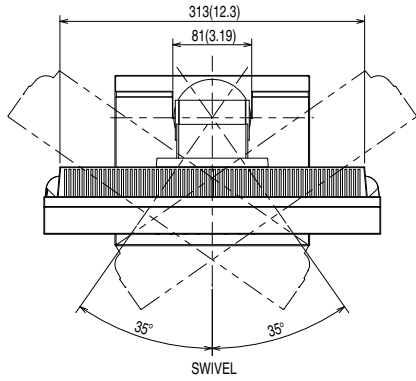

Connector Pin Assignment

- DVI-D connector

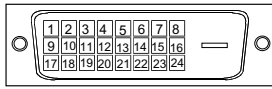

Pin No.	Signal	Pin No.	Signal	Pin No.	Signal
1	TMDS Data 2-	9	TMDS Data1-	17	TMDS Data 0-
2	TMDS Data 2+	10	TMDS Data1+	18	TMDS Data 0+
3	TMDS Data2/4 Shield	11	TMDS Data1/3 Shield	19	TMDS Data 0/5 Shield
4	NC*	12	NC*	20	NC*
5	NC*	13	NC*	21	NC*
6	DDC Clock (SCL)	14	+5V Power	22	TMDS Clock shield
7	DDC Data (SDA)	15	Ground (return for +5V, Hsync and Vsync)	23	TMDS Clock+
8	NC*	16	Hot Plug Detect	24	TMDS Clock-

(NC*: No Connection)

- D-sub mini 15-pin connector

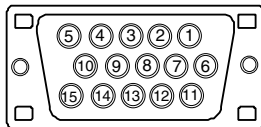

Pin No.	Signal	Pin No.	Signal	Pin No.	Signal
1	Red	6	Red ground	11	NC*
2	Green	7	Green ground	12	Data (SDA)
3	Blue	8	Blue ground	13	H. Sync
4	NC*	9	NC*	14	V. Sync
5	Ground	10	Ground	15	Clock (SCL)

(NC*: No Connection)

- RS-232C port (Mini DIN 6 pin) (T1501-B)



Pin No.	Signal
1	TXD
2	CTS
3	RTS
4	GND
5	RXD
6	GND

- USB port (T1502-B)

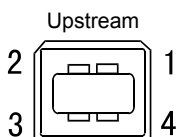

Contact No.	Signal	Remarks
1	VCC	Cable power
2	- Data	Serial data
3	+ Data	Serial data
4	Ground	Cable ground

Option List

Cleaning Kit	EIZO ScreenCleaner
Touch Panel Pointer	TP1

5-4 Glossary

Clock

The analog input monitor needs to reproduce a clock of the same frequency as the dot clock of the graphics system in use, when the analog input signal is converted to a digital signal for image display.

This is called clock adjustment. If the clock pulse is not set correctly, some vertical bars appear on the screen.

DVI (Digital Visual Interface)

DVI is a digital interface standard. DVI allows direct transmission of the PC's digital data without loss.

This adopts the TMDS transmission system and DVI connectors. There are two types of DVI connectors. One is a DVI-D connector for digital signal input only. The other is a DVI-I connector for both digital and analog signal inputs.

DVI DMPM (DVI Digital Monitor Power Management)

DVI DMPM is a digital interface power-saving function. The "Monitor ON (operating mode)" and "Active Off (power-saving mode)" are indispensable for DVI DMPM as the monitor's power mode.

Gain

This is used to adjust each color parameter for red, green and blue. An LCD monitor displays the color by the light passing through the panel color filter. Red, green and blue are the three primary colors. All the colors on the screen are displayed by combining these three colors. The color tone can be changed by adjusting the light intensity (volume) passing through each color's filter.

Gamma

Generally, the monitor brightness varies nonlinearly with the input signal level, which is called "Gamma Characteristic". A small gamma value produces a low-contrast image, while a large gamma value produces a high-contrast image.

Phase

Phase means the sampling timing to convert the analog input signal to a digital signal. Phase adjustment is made to adjust the timing. It is recommended that phase adjustment be made after the clock is adjusted correctly.

Range Adjustment

Range adjustment controls the signal output levels to display every color gradation. It is recommended that range adjustment be made before color adjustment.

Resolution

The LCD panel consists of numerous pixels of specified size, which are illuminated to form images. The display panel of this monitor consists of 1024 horizontal pixels and 768 vertical pixels. At a resolution of 1024 x 768, images are displayed as a full screen (1:1).

sRGB (Standard RGB)

International standard for "color reproduction and color space" among peripheral devices (such as monitors, printers, digital cameras, scanners). sRGB allows Internet users to closely match colors as a simple color matching means for the Internet use.

Temperature

Color temperature is a method to measure the white color tone, generally indicated in degrees Kelvin. The screen becomes reddish at a low temperature, and bluish at a high temperature, like the flame temperature.

5000K: Slightly reddish white

6500K: Warm white like paper white

9300K: Slightly bluish white

TMDS (Transition Minimized Differential Signaling)

A signal transmission system for digital interface.

VESA DPM (Video Electronics Standards Association - Display Power Management)

VESA provides the standardization of signals from PC (graphics board) for power saving of PC monitors. DPM defines the signal status between PC and monitor.

5-5 Preset Timing

The following table shows factory preset video timing (for analog signal only).

Mode	Dot clock		Frequency	Polarity
			Horizontal: kHz Vertical: Hz	
VGA 640×480@60Hz	25.2 MHz	Horizontal	31.47	Negative
		Vertical	59.94	Negative
VGA TEXT 720×400@70Hz	28.3 MHz	Horizontal	31.47	Negative
		Vertical	70.09	Positive
PC-9801 640×400@56Hz	21.1 MHz	Horizontal	24.83	Negative
		Vertical	56.42	Negative
PC-9821 640×400@70Hz	25.2 MHz	Horizontal	31.48	Negative
		Vertical	70.10	Negative
VESA 640×480@72Hz	31.5 MHz	Horizontal	37.86	Negative
		Vertical	72.81	Negative
VESA 640×480@75Hz	31.5 MHz	Horizontal	37.50	Negative
		Vertical	75.00	Negative
VESA 800×600@56Hz	36.0 MHz	Horizontal	35.16	Positive
		Vertical	56.25	Positive
VESA 800×600@60Hz	40.0 MHz	Horizontal	37.88	Positive
		Vertical	60.32	Positive
VESA 800×600@72Hz	50.0 MHz	Horizontal	48.08	Positive
		Vertical	72.19	Positive
VESA 800×600@75Hz	49.5 MHz	Horizontal	46.88	Positive
		Vertical	75.00	Positive
VESA 1024×768@60Hz	65.0 MHz	Horizontal	48.36	Negative
		Vertical	60.00	Negative
VESA 1024×768@70Hz	75.0 MHz	Horizontal	56.48	Negative
		Vertical	70.07	Negative
VESA 1024×768@75Hz	78.8 MHz	Horizontal	60.02	Positive
		Vertical	75.03	Positive

Attention

- Display position may be deviated depending on the PC connected, which may require screen adjustment using Adjustment menu.
- If a signal other than those listed in the table is input, adjust the screen using the Adjustment menu. However, screen display may still be incorrect even after the adjustment.
- When interlace signals are used, the screen cannot be displayed correctly even after screen adjustment using the Adjustment menu.

For U.S.A. , Canada, etc. (rated 100-120 Vac) Only

FCC Declaration of Conformity

We, the Responsible Party

EIZO Inc.

5710 Warland Drive, Cypress, CA 90630

Phone: (562) 431-5011

declare that the product

Trade name: EIZO

Model: FlexScan T1501-B/T1502-B

is in conformity with Part 15 of the FCC Rules. Operation of this product is subject to the following two conditions: (1) this device may not cause harmful interference, and (2) this device must accept any interference received, including interference that may cause undesired operation.

This equipment has been tested and found to comply with the limits for a Class B digital device, pursuant to Part 15 of the FCC Rules. These limits are designed to provide reasonable protection against harmful interference in a residential installation. This equipment generates, uses, and can radiate radio frequency energy and, if not installed and used in accordance with the instructions, may cause harmful interference to radio communications. However, there is no guarantee that interference will not occur in a particular installation. If this equipment does cause harmful interference to radio or television reception, which can be determined by turning the equipment off and on, the user is encouraged to try to correct the interference by one or more of the following measures.

- * Reorient or relocate the receiving antenna.
- * Increase the separation between the equipment and receiver.
- * Connect the equipment into an outlet on a circuit different from that to which the receiver is connected.
- * Consult the dealer or an experienced radio/TV technician for help.

Changes or modifications not expressly approved by the party responsible for compliance could void the user's authority to operate the equipment.

Note

Use the attached specified cable below or EIZO signal cable with this monitor so as to keep interference within the limits of a Class B digital device.

- AC Cord
- Shielded Signal Cable (enclosed)

Canadian Notice

This Class B digital apparatus complies with Canadian ICES-003.

Cet appareil numérique de la classe B est conforme à la norme NMB-003 du Canada.

Hinweise zur Auswahl des richtigen Schwenkarms für Ihren Monitor

Dieser Monitor ist für Bildschirmarbeitsplätze vorgesehen. Wenn nicht der zum Standardzubehör gehörige Schwenkarm verwendet wird, muss statt dessen ein geeigneter anderer Schwenkarm installiert werden. Bei der Auswahl des Schwenkarms sind die nachstehenden Hinweise zu berücksichtigen:

Der Standfuß muß den nachfolgenden Anforderungen entsprechen:

- a) Der Standfuß muß eine ausreichende mechanische Stabilität zur Aufnahme des Gewichtes vom Bildschirmgerät und des spezifizierten Zubehörs besitzen. Das Gewicht des Bildschirmgerätes und des Zubehörs sind in der zugehörigen Bedienungsanleitung angegeben.
- b) Die Befestigung des Standfusses muß derart erfolgen, daß die oberste Zeile der Bildschirmanzeige nicht höher als die Augenhöhe eines Benutzers in sitzender Position ist.
- c) Im Fall eines stehenden Benutzers muß die Befestigung des Bildschirmgerätes derart erfolgen, daß die Höhe der Bildschirmmitte über dem Boden zwischen 135 – 150 cm beträgt.
- d) Der Standfuß muß die Möglichkeit zur Neigung des Bildschirmgerätes besitzen (max. vorwärts: 5°, min. nach hinten $\geq 5^\circ$).
- e) Der Standfuß muß die Möglichkeit zur Drehung des Bildschirmgerätes besitzen (max. $\pm 180^\circ$). Der maximale Kraftaufwand dafür muß weniger als 100 N betragen.
- f) Der Standfuß muß in der Stellung verharren, in die er manuell bewegt wurde.
- g) Der Glanzgrad des Standfusses muß weniger als 20 Glanzeinheiten betragen (seidenmatt).
- h) Der Standfuß mit Bildschirmgerät muß bei einer Neigung von bis zu 10° aus der normalen aufrechten Position kippstabil sein.

„Maschinenlärminformations-Verordnung 3. GPSGV:

Der höchste Schalldruckpegel beträgt 70 dB(A) oder weniger gemäss EN ISO 7779“

Nicht für Bildschirm - Arbeitsplätze geeignet

