



Setup Manual

DuraVision® FDX1502T

Touch Panel Color LCD Monitor







Important

Carefully read this Setup Manual and User's Manual (downloaded from the website) before use to use the monitor correctly. Please retain this manual for future reference.

- Refer to the "User's Manual" for information on the setting / adjustment of the monitor.
- You can check the latest product information, including the Setup Manual, from our web site.
www.eizoglobal.com

SAFETY SYMBOLS

This manual and this product use the safety symbols below. They denote critical information. Please read them carefully.

 WARNING	Failure to abide by the information in a WARNING may result in serious injury and can be life threatening.
 CAUTION	Failure to abide by the information in a CAUTION may result in moderate injury and/or property or product damage.
	Indicates a warning or caution. For example,  indicates an "electrical shock" hazard.
	Indicates a prohibited action. For example,  means "Do not disassemble".

This product has been adjusted specifically for use in the region to which it was originally shipped.

If operated outside this region, the product may not perform as stated in the specifications.

No part of this manual may be reproduced, stored in a retrieval system, or transmitted, in any form or by any means, electronic, mechanical, or otherwise, without the prior written permission of EIZO Corporation.

EIZO Corporation is under no obligation to hold any submitted material or information confidential unless prior arrangements are made pursuant to EIZO Corporation's receipt of said information. Although every effort has been made to ensure that this manual provides up-to-date information, please note that EIZO product specifications are subject to change without notice.





PRECAUTIONS

Important



This product has been adjusted specifically for use in the region to which it was originally shipped. If operated outside this region, the product may not perform as stated in the specifications.

Please read and follow the "PRECAUTIONS" section carefully before use.



Symbols on the unit

Symbol	This symbol indicates
	Power button: Press to turn the monitor's power on or off.
	Direct current
	WEEE marking: Product must be disposed of separately; materials may be recycled.
	CE marking: EU conformity mark in accordance with the provisions of Council Directive and/or Regulation (EU).
	Mark signifying compliance with UK regulations



WARNING



 WARNING	
This product is intended to be housed in an enclosure. Do not use it as a standalone monitor.	
Using the monitor as such may result in electrical shock or equipment damage.	

 WARNING	
If the unit begins to emit smoke, smells like something is burning, or makes strange noises, disconnect all power connections immediately and contact your EIZO representative for advice.	
Attempting to use a malfunctioning unit may result in fire, electrical shock, or equipment damage.	

 WARNING	
Do not disassemble or modify the unit.	
Opening the cabinet may result in electrical shock or burn by high-voltage or high-temperature parts. Modifying the unit may result in fire or electrical shock.	

 WARNING	
Refer all servicing to qualified service personnel.	
Do not attempt to service this product yourself as opening or removing covers may result in fire, electrical shock, or equipment damage.	

 WARNING	
Keep foreign objects or liquids away from the unit.	
Metal parts, flammable materials, or liquids accidentally falling into the cabinet may result in fire, electrical shock, or equipment damage.	
If an object or liquid falls/spills into the cabinet, unplug the unit immediately. Have the unit checked by a qualified service engineer before using it again.	

 WARNING	
Use the unit in an appropriate location.	
Otherwise, fire, electrical shock, or equipment damage may result.	
<ul style="list-style-type: none"> • Do not place outdoors. • Do not place in any form of transportation (ships, aircraft, trains, automobiles, etc.). • Do not place in dusty or humid environments. • Do not place in locations where water may be splashed on the screen (bathrooms, kitchens, etc.) • Do not place in locations where steam comes in direct contact with the screen. • Do not place near heat generating devices or humidifiers. • Do not place in locations where the product is subject to direct sunlight. • Do not place in environments with inflammable gas. • Do not place in environments with corrosive gases (such as sulfur dioxide, hydrogen sulfide, nitrogen dioxide, chlorine, ammonia, and ozone). • Do not place in environments with dust, components that accelerate corrosion in the atmosphere (such as sodium chloride and sulfur), conductive metals, and so on. 	

 **WARNING**

Keep the plastic packing bags away from babies and children.

The plastic packing bags may cause suffocation.

 **WARNING**

When attaching an arm stand, please refer to the User's Manual of the arm stand and install the unit securely.

Otherwise, the unit may become detached, resulting in injury and/or equipment damage.

Before installation, make sure that desks, walls, or any other installation surface has adequate mechanical strength.

If the unit falls, disconnect the power immediately and ask your local EIZO representative for advice.

Do not continue using a damaged unit. Using a damaged unit may result in fire or electrical shock.

When reattaching the tilt stand, please use the same screws and tighten them securely.

 **WARNING**

Do not touch a damaged LCD panel directly with bare hands.

If any part of your skin comes in direct contact with the panel, wash thoroughly.

If liquid crystal enters your eyes or mouth, immediately flush with large amounts of water and seek medical attention. Otherwise, you may have a toxic reaction.



 **WARNING**

For installment in high locations, ask for the help of a professional.

When installing the monitor in a high location, there is a risk of the product or its parts falling and causing injury. Ask for help from us or from a professional who specializes in construction work when installing the monitor, including an inspection of the product for any damage or deformities both before and after installing the monitor.

CAUTION

 **CAUTION**

Disconnect cables and remove accessories when moving the unit.

Otherwise, the cables or accessories may become detached when moving, resulting in injury.

 **CAUTION**

Do not block the ventilation slots on the cabinet.

- Do not place any objects on the ventilation slots.
- Do not install the unit in a place with poor ventilation or inadequate space.
- Do not use the unit laid down or upside down.

Blocking the ventilation slots prevents proper airflow and may result in fire, electrical shock, or equipment damage.



 **CAUTION**

Do not use the power jack and DC power terminal block at the same time.

Doing so may result in fire, electrical shock, or damage to the power system.



 **CAUTION**

Periodically check the tightness of screws.

If not sufficiently tight, the monitor may detach from the arm, which may result in injury or equipment damage.

About This Product

About the Usage of This Product

- This product is suitable for industrial applications.
- It is not intended for use in applications such as the following that require extremely high reliability and safety. Please refrain from using it for such purposes.
 - Safety devices (Disaster prevention systems, security control systems, etc.)
 - Life-critical devices (medical devices, such as life-support devices and operating room devices)
 - Nuclear energy control devices (Nuclear energy control systems, security control systems of nuclear facilities, etc.)
 - Major system communication devices (operation control systems of transportation systems, air traffic control systems, etc.)
- This product has been adjusted specifically for use in the region to which it was originally shipped. If the product is used outside the region, it may not operate as specified in the specifications.
- This product may not be covered by warranty for uses other than those described in this manual.
- The specifications noted in this manual are only applicable when the following are used:
 - Signal cables specified by us
- Only use optional products manufactured or specified by us with this product.

About the LCD Panel

- It takes about 30 minutes (under our measurement conditions) for the monitor display to stabilize. Please wait 30 minutes or more after the monitor power has been turned on, and then adjust the monitor.
- Monitors should be set to a lower brightness to prevent a loss in the screen quality caused by long-term use and to maintain stable use.
- When the screen image is changed after displaying the same image for extended periods of time, an afterimage may remain. Use the screensaver or power save function to avoid displaying the same image for extended periods of time. An afterimage may appear even after a short time period has elapsed depending on the displayed image. To remove such a phenomenon, change the image or keep the power turned off for several hours.
- If the monitor displays continuously over a long period of time, smudges or burn-in may appear. To maximize the life of the monitor, we recommend the monitor be turned off periodically.
- The LCD panel is manufactured using high-precision technology. Although, missing pixels or lit pixels may appear on the LCD panel, this is not a malfunction. Percentage of effective dots: 99.9994 % or higher.
- The backlight of the LCD panel has a fixed lifetime. Depending on the usage pattern, such as usage for long continuous periods, the lifespan of the backlight may run out sooner, requiring replacement. When the screen becomes dark or begins to flicker, please contact your local EIZO representative.
- Do not scratch or press on the LCD panel with any sharp objects, at this may result in damage to the LCD panel. Do not attempt to brush with tissues as this may scratch the panel.

- (Cautions for the Use of the Touch Panel)
During touch operation
Be careful of the following points. Otherwise, damage may occur to the monitor.
 - Do not strongly press, scratch, or poke the touch panel.
 - Do not touch the touch panel with hard objects such as ballpoint pens or metals.

About the Installation

- Dew condensation may form on the surface or interior of this product when it is brought into a cold room, when the temperature suddenly rises, or when it is moved from a cold room to a warm room. In that case, do not turn the product on. Instead wait until the dew condensation disappears, otherwise it may cause some damage to the product.

Cleaning

- Periodic cleaning is recommended to keep the product looking new and to prolong its operation lifetime.
- Stains on the product can be removed by moistening part of a soft cloth with water or by using our ScreenCleaner and gently wiping.

Attention

- Do not let liquids come into direct contact with the product. If it does, wipe it off immediately.
- Do not allow liquids to get into gaps or inside the product.
- When using chemicals for cleaning or disinfection, chemicals such as alcohol and disinfectant may cause gloss variation, tarnishing, and fading of the product, and also quality deterioration of the displayed image. Do not use chemicals on a frequent basis.
- Never use a thinner, benzene, wax, or abrasive cleaner as they may damage the product.
- For more information on cleaning and disinfection, please refer to our web site.
How to check: Access www.eizoglobal.com and type "disinfect" in the site search box to search.

To Use the Monitor Comfortably

- An excessively dark or bright screen may affect your eyes. Adjust the brightness of the monitor according to the environmental conditions.
- Staring at the monitor for a long time tires your eyes. Take a 10-minute rest every hour.
- Look at the screen from a proper distance and from a proper angle.

CONTENTS

PRECAUTIONS	3
Important	3
Symbols on the unit	3
About This Product	7
About the Usage of This Product	7
About the LCD Panel	7
About the Installation.....	8
Cleaning	8
To Use the Monitor Comfortably	8
1 Introduction	11
1.1 Package Contents	11
1.2 Controls and Functions	12
2 Installation / Connection	14
2.1 Installing	14
2.1.1 Installation conditions.....	14
2.1.2 How to assemble	14
2.2 Connecting Cables.....	15
2.3 Turning On the Power	18
2.4 Installing the Touch Panel Driver	19
2.5 Correct the touch position	19
3 Reference	20
3.1 Specifications	20
3.1.1 LCD Panel.....	20
3.1.2 Touch Panel.....	20
3.1.3 Video Signals	20
3.1.4 Communication	21
3.1.5 DC Power (DC Power Terminal Block).....	21
3.1.6 DC Power (Power Jack).....	21
3.1.7 Physical Specifications	21
3.1.8 Operating Environmental Requirements.....	21
3.1.9 Transport / Storage Conditions	21
3.2 Pin Specifications.....	22
3.2.1 DC power terminal block.....	22
3.2.2 Control button extension connector	22
Appendix	23
Information for Radio Interference	23
For U.S.A., Canada Only	23

CONTENTS

LIMITED WARRANTY 24

1 Introduction

Thank you very much for choosing an EIZO color LCD monitor.

1.1 Package Contents

Check that all of the following items are contained in the package. If any of these are missing or damaged, contact your dealer or local EIZO representative.

Note

- The User's Manual is not included with the product. Please download it from our web site using the steps below.
 1. Access www.eizoglobal.com.
 2. From the menu, select "Support" > "Manuals".
 3. In the "Enter model name" text box, enter "FDX1502T", and then press the "Search" button.
 4. Click the icon for the User's Manual.
- It is recommended that the box and packing materials be stored so that they can be used to move or transport this product.

- Monitor
- D-Sub mini 15-pin cable (D-Sub - D-Sub): MD-C87 x 1



- HDMI cable (HDMI - HDMI): HH200HS x 1



- USB cable (USB-A – USB-B): MD-C93 x 1



- Setup Manual (this document)
- VESA mounting screws M4x10 x 4
- Cable clamp x 3
- Cable clamp fixing screws M4x10 x 3

1.2 Controls and Functions

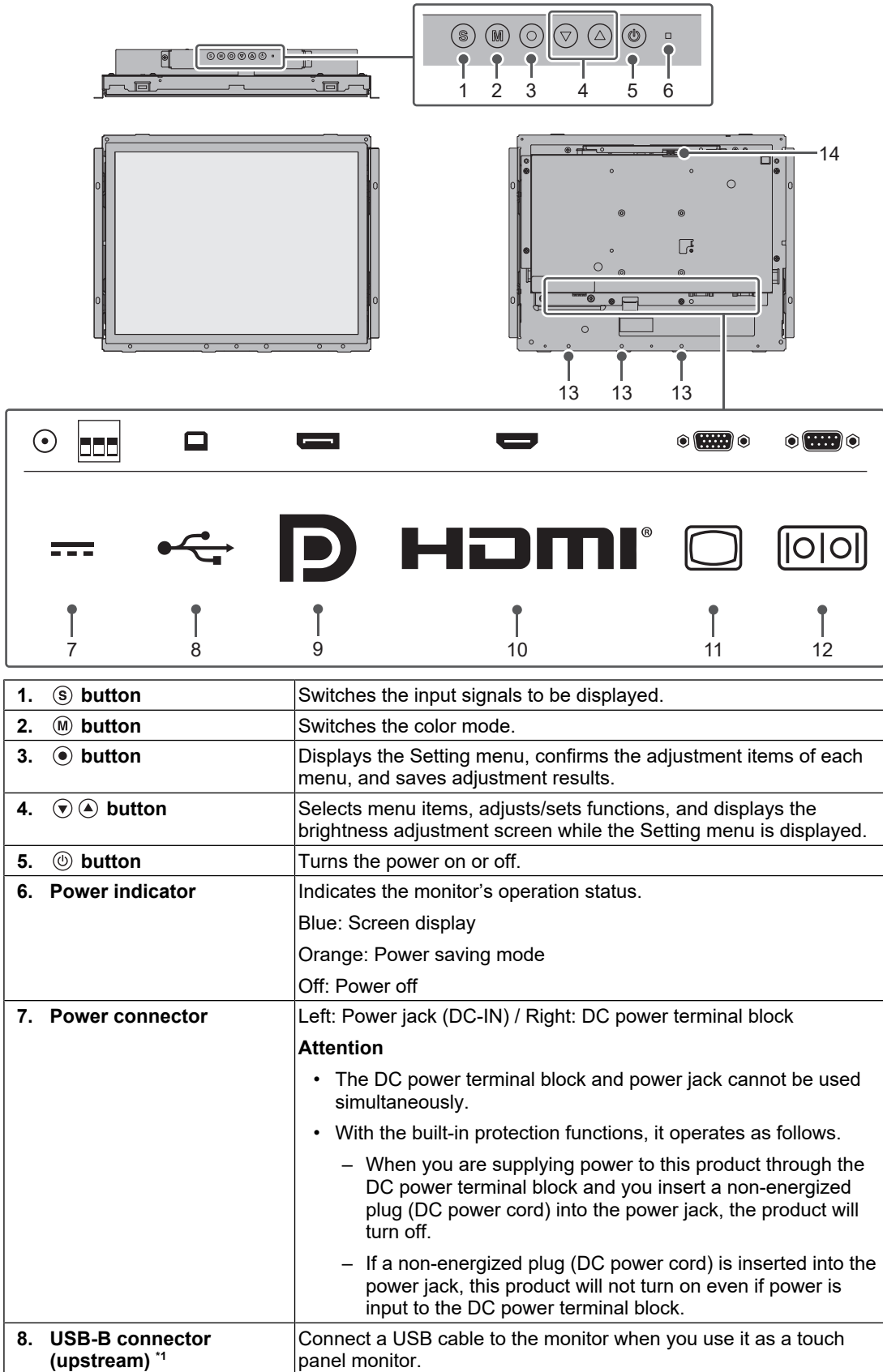

9. DisplayPort™ connector	Connects to a PC with a DisplayPort output.
10. HDMI connector	Connects to a PC with HDMI output.
11. D-Sub15 pin (mini) connector	Connects to a PC with D-Sub output.
12. RS-232C port^{*1*}	Connect a RS-232C cable to the monitor when you use it as a touch panel monitor.
13. Screw holes for cable clamp fixing (3 locations)	Attach a clamp to prevent the cable from disconnecting. Fit the cable into the clamp and secure it with the screw (M4x10).
14. Control button extension connector	Extension connector for use with external control buttons.

*1 Cannot be used simultaneously.

*2 In the default settings, RS-232C serial transfer is disabled. For details on how to change the settings, see "Functions of the Administrator Settings Menu" in the User's Manual.

2 Installation / Connection

2.1 Installing

2.1.1 Installation conditions

The screen orientations that can be set are as follows:

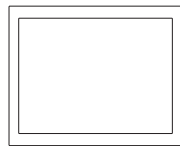

No rotation

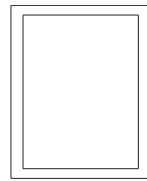

Rotate 90° right

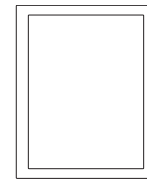

Rotate 90° left

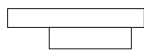

Up: 90°

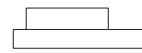

Down: 90°

2.1.2 How to assemble

Attention

- Mounting screws are not included with this product. Prepare M3 screws separately for the assembly enclosure.
- Before installing into the case, first adjust the monitor settings and install the touch panel driver.
- When assembling it into the monitor, be careful not to cut or pinch your fingers.
- If you are installing the panel in a vertical position, please ensure that there are two or more people involved in the process.

1. Fasten the screws through the enclosure mounting holes of the monitor into the enclosure (4 locations).

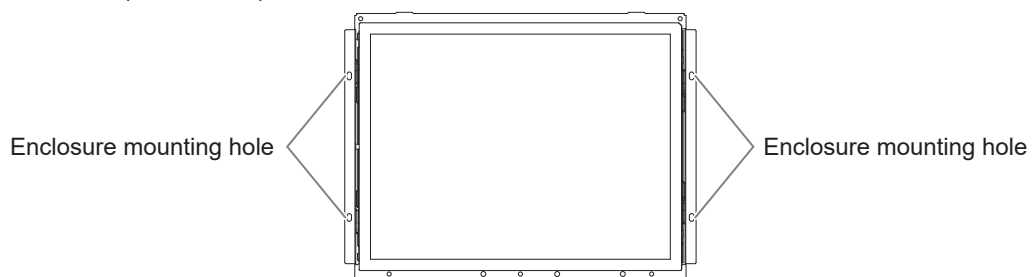

2. Make sure the monitor is firmly fixed without wobbling or looseness.

2.2 Connecting Cables

Attention

- Check that the monitor, PC, and peripherals are powered off.
- When replacing the current monitor with this monitor, refer to "Compatible Resolutions" in the User's Manual to change the PC settings for resolution and vertical scan frequency to those that are available for this monitor, before connecting the PC.

1. Connect signal cables.

Check the shapes of the connectors, and connect the cables. When connecting an HDMI® cable, fasten the cable with the supplied cable clamp. When connecting a D-Sub mini 15-pin cable, tighten the fasteners down to secure the connector.

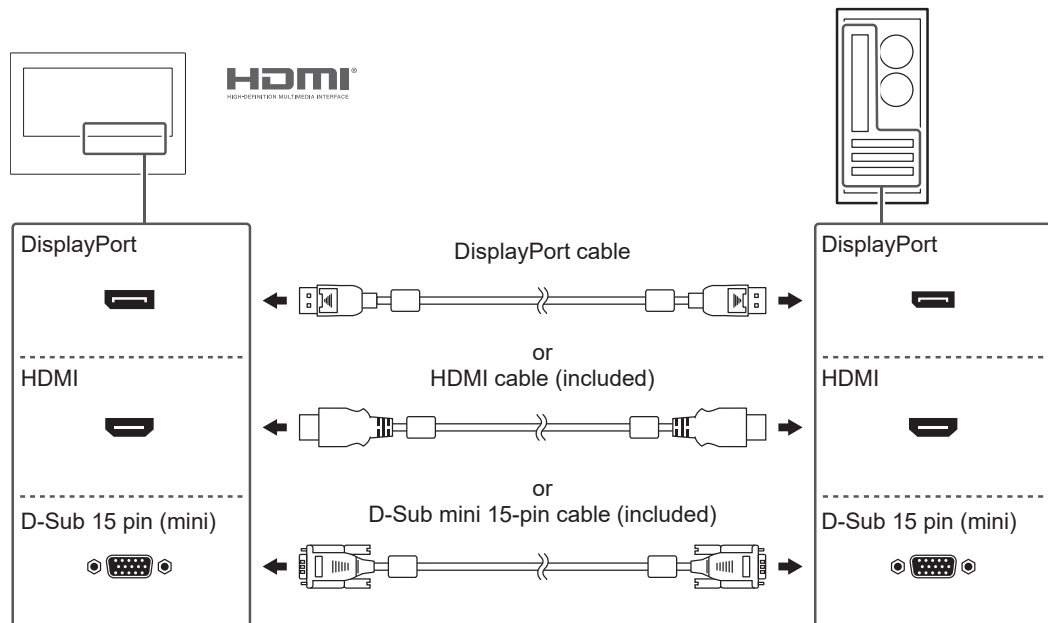

Attention

- When connecting to multiple PCs, switch the input signal. Refer to the User's Manual for details.

2. Use either the USB cable or the RS-232C cable to connect the PC to the monitor.

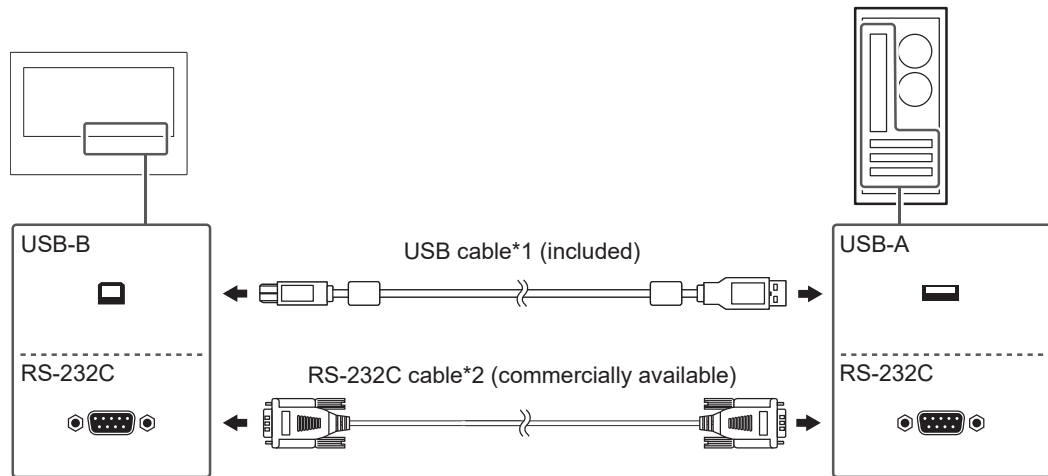

- *1 When connecting an USB cable, fasten the cable with the supplied cable clamp.
- *2 Cross type. The connector type on the monitor is D-Sub 9-pin. In the default settings, RS-232C serial transfer is disabled. For details on how to change the settings, see "Functions of the "Administrator Settings" Menu" in the User's Manual.
3. Connect the monitor to a power source.
There are two methods for connecting the power supply: using the DC power terminal block and using the DC power jack (DC-IN). Connect with one of these methods according to the installation environment and usage conditions.

Attention

- The DC power terminal block and power jack cannot be used simultaneously.
- With the built-in protection functions, it operates as follows.
 - When you are supplying power to this product through the DC power terminal block and you insert a non-energized plug (DC power cord) into the power jack, the product will turn off.
 - If a non-energized plug (DC power cord) is inserted into the power jack, this product will not turn on even if power is input to the DC power terminal block.

Using the DC power terminal block

Attention

- Use wires with a gauge size of AWG 18 to 12 (0.8 mm² to 3 mm²).

1. Remove the terminal block.

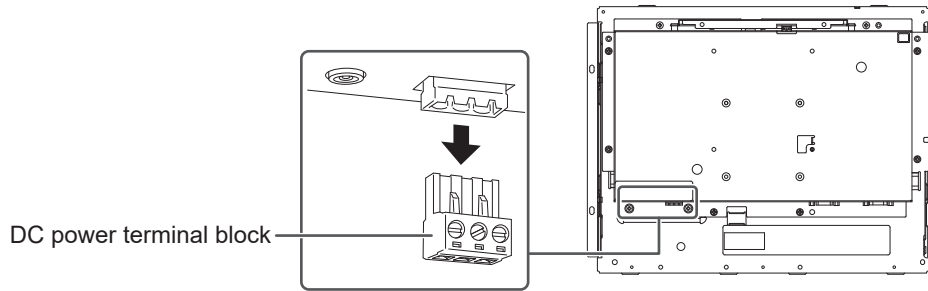

2. Strip the wire insulation (strip length: 7 mm ± 0.5 mm). If tip treatment is required, attach a rod terminal (ferrule). Use ferrules made by Phoenix Contact.

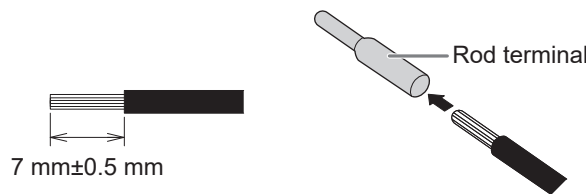

3. Insert the wires into the terminal block and tighten the clamp screws with a flat-head screwdriver with a tip width of 2.5 mm (recommended torque: 0.5 N·m to 0.6 N·m).

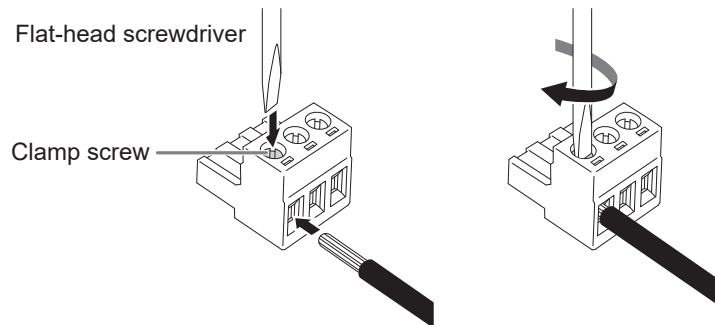

Input signal connection

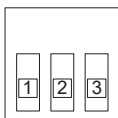

Pin No.	Input signal
1	DC 12 - 24 V
2	NC
3	GND (Ground)

4. Attach the terminal block.

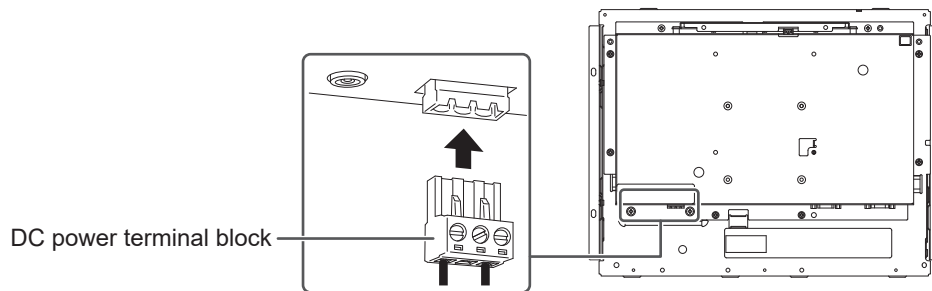

Using the DC power jack (DC-IN)

1. Insert the DC power cord firmly into the DC power jack.

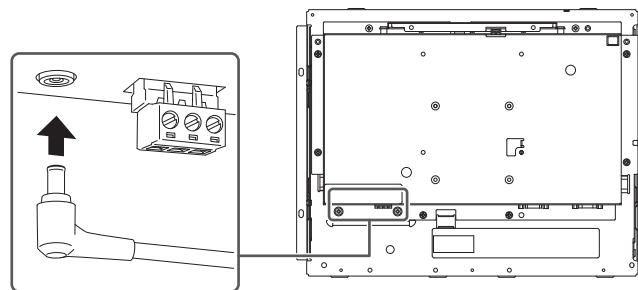

2.3 Turning On the Power

1. Press  to turn on the power of the monitor.
The power switch indicator of the monitor lights up blue.
If the power indicator does not light up, refer to "No Picture" in the User's Manual.
2. Turn on the PC.
The screen image appears.
If the screen image does not appear after turning on the PC, refer to "No Picture" in the User's Manual.

Attention

- For maximum power saving, it is recommended to unplug the power plug of the monitor. When not using the monitor, you can disconnect the power plug so that the power is cut completely.

2.4 Installing the Touch Panel Driver

Attention

- To install the touch panel driver, the user account needs "Administrator" privileges.
- To reinstall the touch panel driver in order to update the driver, uninstall the driver, and then restart the PC before installation.

1. Download the touch panel driver from our web site.

Note

- Use the following procedure to download the touch panel driver from our web site.
 1. Access www.eizoglobal.com.
 2. From the menu, select "Support" > "Software and Drivers".
 3. In the "Enter name of model or software" text box, enter "FDX1502T", and then press the "Search" button.
 4. Click the ZIP icon for the touch panel driver.

2. If another touch panel driver is installed, uninstall it.
3. Install the downloaded touch panel driver.
For information on how to install the touch panel driver, refer to the User's Manual of the touch panel driver.
4. Reboot the PC.

2.5 Correct the touch position

Correct the touch position according to the User's Manual of the touch panel driver.

Note

- If the installation location is changed, correct the touch position.

3 Reference

3.1 Specifications

3.1.1 LCD Panel

Type	TN (Anti-Glare)	
Backlight	LED	
Size	15.0" (38.0 cm)	
Resolution	1024 dots x 768 lines	
Display Size (H x V)	304.1 mm x 228.1 mm	
Pixel Pitch	0.297 mm x 0.297 mm	
Display Colors	8-bit colors: 16.77 million colors	
Viewing Angle (H / V, typical)	160° / 160°	
Contrast Ratio (typical)	600:1	
Response time (typical)	Black -> White -> Black	8 ms

3.1.2 Touch Panel

Surface coating	Anti-glare	
Surface hardness	2H	
Communication method	USB transfer ^{*1} , RS-232C transfer ^{*1}	
Detection method	Resistive film type	
Supported Operating Systems ^{*2}	Windows 11 Windows 10 (32 bit / 64 bit)	

*1 These cannot be used simultaneously.

*2 EIZO support will end when OS vendor support ends.

3.1.3 Video Signals

Input Terminals	DisplayPort (HDCP 1.3 compatible) x 1, HDMI (HDCP 1.4 compatible) ^{*1} x 1, D-Sub 15 pin (mini) x 1	
Digital Scanning Frequency (H / V ^{*2})	DisplayPort, HDMI	31 kHz – 49 kHz / 59 Hz – 61 Hz, 69 Hz – 71 Hz (at 720 x 400)
Analog Scanning Frequency (H / V ^{*2})	D-Sub	31 kHz to 61 kHz / 55 Hz to 76 Hz
Dot clock (Max.)	DisplayPort, HDMI	65 MHz
	D-Sub	80 MHz
Synchronization Signal	H / V separate, positive / negative	

*1 HDMI CEC (mutual control) is not supported.

*2 The vertical scan frequency supported varies according to the resolution. For more information, see "Compatible Resolutions" in the User's Manual.

3.1.4 Communication

USB	Port	USB-B connector (upstream) x 1
	Standard	USB Specification Revision 2.0
RS-232C	Port	D-Sub 9-pin (male) x 1

3.1.5 DC Power (DC Power Terminal Block)

Input		DC 12 - 24 V \pm 10 %
Maximum Power Consumption		Less than 16 W (DC 12 V) Less than 17 W (DC 24 V)
Maximum Input Current		Less than 1.35 A (DC 12 V) Less than 0.7 A (DC 24 V)
Inrush Current ^{*1}		Less than 5 A (DC 12 - 24 V)
Power Save Mode ^{*2}	With USB connection	Less than 1.5 W (DC 12 V) Less than 1.5 W (DC 24 V)
	Without USB connection	Less than 0.3 W (DC 12 V) Less than 0.3 W (DC 24 V)
Standby Mode ^{*2}		Less than 0.3 W (DC 12 V) Less than 0.3 W (DC 24 V)

*1 Use a power source that meets the inrush current requirement

*2 No external load is connected, default setting

3.1.6 DC Power (Power Jack)

Input		DC 12 V \pm 10 %
Maximum Power Consumption		16 W or less
Maximum Input Current		Less than 1.35 A
Power Save Mode ^{*1}	With USB connection	0.7 W or less
	Without USB connection	0.3 W or less
Standby Mode ^{*1}		0.3 W or less

*1 No external load is connected, default setting

3.1.7 Physical Specifications

Dimensions (W x H x D)	357.4 mm x 273.4 mm x 61.0 mm
Net Weight	Approx. 3.0 kg

3.1.8 Operating Environmental Requirements

Temperature	0 °C – 50 °C
Humidity	20 % – 90 % R.H. (no dew condensation)
Air Pressure	540 hPa – 1060 hPa

3.1.9 Transport / Storage Conditions

Temperature	-20 °C – 60 °C
Humidity	10 % – 90 % R.H. (no dew condensation)
Air Pressure	200 hPa – 1060 hPa

3.2 Pin Specifications

3.2.1 DC power terminal block

Input signal connection

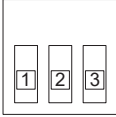

Pin No.	Input signal
1	DC 12 - 24 V
2	NC
3	GND (Ground)

Power sequencing

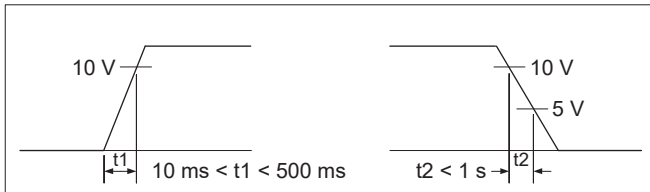

3.2.2 Control button extension connector

Connector used: S3B-PH-SM4-TB(LF)(SN) (JST)

Input signal connection

Pin No.	Input signal
1	KEY0
2	KEY1
3	GND (Ground)

Appendix

Information for Radio Interference

For U.S.A., Canada Only

FCC Supplier's Declaration of Conformity

We, the Responsible Party

Company: EIZO Inc.

Address: 5710 Warland Drive, Cypress, CA 90630

Phone: (562) 431-5011

declare that the product

Trade name: EIZO

Model: DuraVision FDX1502T

is in conformity with Part 15 of the FCC Rules. Operation of this product is subject to the following two conditions: (1) this device may not cause harmful interference, and (2) this device must accept any interference received, including interference that may cause undesired operation.

This equipment has been tested and found to comply with the limits for a Class B digital device, pursuant to Part 15 of the FCC Rules. These limits are designed to provide reasonable protection against harmful interference in a residential installation. This equipment generates, uses, and can radiate radio frequency energy and, if not installed and used in accordance with the instructions, may cause harmful interference to radio communications. However, there is no guarantee that interference will not occur in a particular installation. If this equipment does cause harmful interference to radio or television reception, which can be determined by turning the equipment off and on, the user is encouraged to try to correct the interference by one or more of the following measures.

- Reorient or relocate the receiving antenna.
- Increase the separation between the equipment and receiver.
- Connect the equipment into an outlet on a circuit different from that to which the receiver is connected.
- Consult the dealer or an experienced radio/TV technician for help.

Changes or modifications not expressly approved by the party responsible for compliance could void the user's authority to operate the equipment.

Note

Use the attached specified cable below or EIZO signal cable with this monitor so as to keep interference within the limits of a Class B digital device.

- AC Cord
- Shielded Signal Cable (enclosed)

Canadian Notice

This Class B information technology equipment complies with Canadian ICES-003.
Cet équipement informatique de classe B est conforme à la norme NMB-003 du Canada.

LIMITED WARRANTY

EIZO Corporation (hereinafter referred to as “EIZO”) and distributors authorized by EIZO (hereinafter referred to as the “Distributors”) warrant, subject to and in accordance with the terms of this limited warranty (hereinafter referred to as the “Warranty”), to the original purchaser (hereinafter referred to as the “Original Purchaser”) who purchased the product specified in this document (hereinafter referred to as the “Product”) from EIZO or Distributors, that EIZO and Distributors shall, at their sole discretion, either repair or replace the Product at no charge if the Original Purchaser becomes aware within the Warranty Period (defined below) that the Product malfunctions or is damaged in the course of normal use of the Product in accordance with the description in the instruction manual of the Product (hereinafter referred to as the “User’s Manual”).

The period of this Warranty is three (3) years from the date of purchase of the Product (hereinafter referred to as the “Warranty Period”).

EIZO and Distributors shall bear no liability or obligation with regard to the Product in relation to the Original Purchaser or any third parties other than as provided under this Warranty.

EIZO and Distributors will cease to hold or store any parts (excluding design parts) of the Product upon expiration of seven (7) years after the production of the Product is discontinued.

In repairing the Product, EIZO and Distributors will use renewal parts which comply with our QC standards. If the unit cannot be repaired due to its condition or the stockout of a relevant part, EIZO and Distributors may offer the replacement by a product with equivalent performance instead of repairing it.

The Warranty is valid only in the countries or territories where the Distributors are located. The Warranty does not restrict any legal rights of the Original Purchaser.

Notwithstanding any other provision of this Warranty, EIZO and Distributors shall have no obligation under this Warranty whatsoever in any of the cases as set forth below:

1. Any defect of the Product caused by freight damage, modification, alteration, abuse, misuse, accident, incorrect installation, disaster, adherent dust, faulty maintenance and/or improper repair by third party other than EIZO and Distributors;
2. Any incompatibility of the Product due to possible technical innovations and/or regulations;
3. Any deterioration of the sensor, including measurement value of the sensor;
4. Any defect of the Product caused by external equipments;
5. Any defect of the Product caused by the use under environmental conditions not anticipated by EIZO;
6. Any deterioration of the attachments of the Product (e.g. cables, User’s Manual, CD-ROM, etc.);
7. Any deterioration of the consumables, and/or accessories of the Product (e.g. batteries, remote controller, touch pen, etc.);
8. Any exterior deterioration or discoloration of the Product, including that of the surface of the LCD panel, the touch panel and the protect panel;
9. Any defect of the Product caused by placement in a location where it may be affected by strong vibrations or shocks;
10. Any defect of the Product caused by leaking battery liquid;

11. Any deterioration of display performance caused by the deterioration of expendable parts such as the LCD panel and/or backlight, etc. (e.g. changes in brightness, changes in brightness uniformity, changes in color, changes in color uniformity, defects in pixels including burnt pixels, etc.);

12. Any deterioration or malfunction of the cooling fan caused by adherent dust.

To obtain service under the Warranty, the Original Purchaser must deliver the Product, freight prepaid, in its original package or other adequate package affording an equal degree of protection, assuming the risk of damage and/or loss in transit, to the local Distributor. The Original Purchaser must present proof of purchase of the Product and the date of such purchase when requesting services under the Warranty.

The Warranty Period for any replaced and/or repaired product under this Warranty shall expire at the end of the original Warranty Period.

EIZO OR DISTRIBUTORS ARE NOT RESPONSIBLE FOR ANY DAMAGE TO, OR LOSS OF, DATA OR OTHER INFORMATION STORED IN ANY MEDIA OR ANY PART OF ANY PRODUCT RETURNED TO EIZO OR DISTRIBUTORS FOR REPAIR.

EIZO AND DISTRIBUTORS MAKE NO FURTHER WARRANTIES, EXPRESSED OR IMPLIED, WITH RESPECT TO, INCLUDING, WITHOUT LIMITATION, THE PRODUCT AND ITS QUALITY, PERFORMANCE, MERCHANTABILITY OR FITNESS FOR ANY PARTICULAR USE.

IN NO EVENT SHALL EIZO OR DISTRIBUTORS BE LIABLE FOR ANY INCIDENTAL, INDIRECT, SPECIAL, CONSEQUENTIAL OR OTHER DAMAGE WHATSOEVER (INCLUDING, WITHOUT LIMITATION, DAMAGES FOR LOSS OF PROFIT, BUSINESS INTERRUPTION, LOSS OF BUSINESS INFORMATION, OR ANY OTHER PECUNIARY LOSS) ARISING OUT OF THE USE OR INABILITY TO USE THE PRODUCT OR IN ANY CONNECTION WITH THE PRODUCT, WHETHER BASED ON CONTRACT, TORT, NEGLIGENCE, STRICT LIABILITY OR OTHERWISE, EVEN IF EIZO OR DISTRIBUTORS HAVE BEEN ADVISED OF THE POSSIBILITY OF SUCH DAMAGES.

THIS EXCLUSION ALSO INCLUDES ANY LIABILITY WHICH MAY ARISE OUT OF THIRD PARTY CLAIMS AGAINST THE ORIGINAL PURCHASER. THE ESSENCE OF THIS PROVISION IS TO LIMIT THE POTENTIAL LIABILITY OF EIZO AND DISTRIBUTORS ARISING OUT OF THIS LIMITED WARRANTY AND/OR SALES.



EIZO Corporation

153 Shimokashiwano, Hakusan, Ishikawa 924-8566 Japan

EIZO Europe GmbH

Belgrader Straße 2, 41069 Mönchengladbach, Germany

艺卓显像技术(苏州)有限公司

中国苏州市苏州工业园区展业路8号中新科技工业坊5B

www.eizoglobal.com

Copyright © 2023 EIZO Corporation. All rights reserved.

00N0N461A1
SUM-FDX1502T-4

1st Edition – December, 2023