

取扱説明書 User's Manual 用户手册

DuraVision® FDX1001T FDV1001T FDX1201T

タッチパネル装着カラー液晶モニター
Touch Panel Color LCD Monitor
触摸式彩色液晶显示器

重要

ご使用前には必ず本取扱説明書をよくお読みになり、正しくお使いください。この取扱説明書は大切に保管してください。

Important

Please read this User's Manual carefully to familiarize yourself with safe and effective usage. Please retain this manual for future reference.

重要事项

请仔细阅读用户手册，掌握如何安全、有效地使用本产品。请保留本手册，以备日后参考。







User's Manual

DuraVision®
FDX1001T
FDV1001T
FDX1201T

Touch Panel Color LCD Monitor

SAFETY SYMBOLS

This manual and this product use the safety symbols below. They denote critical information. Please read them carefully.

 WARNING	
Failure to abide by the information in a WARNING may result in serious injury and can be life threatening.	
 CAUTION	
Failure to abide by the information in a CAUTION may result in moderate injury and/or property or product damage.	
	Indicates an attention to be required.
	Indicates a prohibited action.

Using the special functions, such as screen size change (ex. changing the horizontal and vertical ratio of images input) for commercial purposes or for the purpose of showing in public may violate copyright laws.

No part of this manual may be reproduced, stored in a retrieval system, or transmitted, in any form or by any means, electronic, mechanical, or otherwise, without the prior written permission of EIZO Corporation.

EIZO Corporation is under no obligation to hold any submitted material or information confidential unless prior arrangements are made pursuant to EIZO Corporation's receipt of said information. Although every effort has been made to ensure that this manual provides up-to-date information, please note that EIZO monitor specifications are subject to change without notice.

Apple, ColorSync, eMac, iBook, iMac, iPad, Mac, MacBook, Macintosh, Mac OS, PowerBook, and QuickTime are registered trademarks of Apple Inc.

Windows, Windows Media, Windows Vista, SQL Server, and Xbox 360 are registered trademarks of Microsoft Corporation in the United States and other countries.

VESA is a registered trademark of Video Electronics Standards Association.

NEC is a registered trademark of NEC Corporation.

PC-9801 and PC-9821 are trademarks of NEC Corporation.

EIZO, the EIZO Logo, ColorEdge, DuraVision, FlexScan, FORIS, RadiCS, RadiForce, RadiNET, Raptor, and ScreenManager are registered trademarks of EIZO Corporation in Japan and other countries.

All other company and product names are trademarks or registered trademarks of their respective owners.

PRECAUTIONS

IMPORTANT

- This product is intended to be used with an industrial device designed to build industrial systems.
 - Transportation systems (Ship, aircraft, train, automobile, etc.)
 - Safety devices (Disaster prevention system, security control system, etc.)
 - Equipment with direct effect on human life (Life support systems, Medical equipment or devices used in the operating room, etc.)
 - Nuclear energy control devices (Nuclear energy control systems, security control systems of nuclear facilities, etc.)
 - Main line devices (Operation control for transportation, control systems specific to aircrafts, etc.)
- To ensure personal safety and proper maintenance, please read this section.

WARNING

This product is intended to be housed in an enclosure. Do not use the bare monitor separately.

Attempting to use a malfunctioning unit may result in electric shock, or equipment damage.



If the unit begins to emit smoke, smells like something is burning, or makes strange noises, disconnect all power connections immediately and contact your dealer for advice.

Attempting to use a malfunctioning unit may result in fire, electric shock, or equipment damage.

Do not open the cabinet or modify the unit.

Opening the cabinet or modifying the unit may result in fire, electric shock, or burn.



Refer all servicing to qualified service personnel.

Do not attempt to service this product yourself as opening or removing covers may result in fire, electric shock, or equipment damage.

Keep small objects or liquids away from the unit.

Small objects accidentally falling through the ventilation slots into the cabinet or spillage into the cabinet may result in fire, electric shock, or equipment damage. If an object or liquid falls/spills into the cabinet, unplug the unit immediately. Have the unit checked by a qualified service engineer before using it again.



Use the unit in an appropriate location.

Not doing so may result in fire, electric shock, or equipment damage.

- Do not place outdoors.
- Do not place in a transportation system (ship, aircraft, train, automobile, etc.) where it may be affected by strong vibration or shock.
- Do not place in a dusty or humid environment.
- Do not place in a location where water is splashed on the screen (bathroom, kitchen, etc.).
- Do not place in a location where the steam comes directly on the screen.
- Do not place near heat generating devices or a humidifier.
- Do not place in a location where the product is subject to direct sunlight.
- Do not place in an inflammable gas environment.



Do not touch a damaged LCD panel directly with bare hands.

The liquid crystal that may leak from the panel is poisonous if it enters the eyes or mouth. If any part of the skin or body comes in direct contact with the panel, please wash thoroughly. If some physical symptoms result, please consult your doctor.



 **CAUTION**

Handle with care when carrying the unit.

Disconnect the power cord and cables when moving the unit. Moving the unit with the cord attached is dangerous. It may result in injury.

Do not install the unit in a closed space.

If the interior becomes hot, it may result in fire, electric shock or damage.



Notice for this monitor

This product may not be covered by warranty for uses other than those described in this manual.

Only use optional products manufactured or specified by us with this product.

As it takes about 30 minutes for the performance of electrical parts to stabilize, adjust the monitor 30 minutes or more after the monitor power has been turned on.

Monitors should be set to a lower brightness to reduce changes in luminosity caused by long-term use and maintain a stable display.

When the screen image is changed after displaying the same image for extended periods of time, an afterimage may appear. Use the screen saver or power save function to avoid displaying the same image for extended periods of time.

Periodic cleaning is recommended to keep the monitor looking new and to prolong its operation lifetime. (refer to “Cleaning” on the next page.)

The LCD panel is manufactured using high-precision technology. Although, missing pixels or lit pixels may appear on the LCD panel, this is not a malfunction. Percentage of effective dots: 99.99% or higher.

The backlight of the LCD panel has a fixed lifetime. When the screen becomes dark or begins to flicker, please contact your local EIZO representative.

Do not scratch or press on the panel with any sharp objects, as this may result in damage to the panel. Do not attempt to brush with tissues as this may scratch the panel.

When the monitor is cold and brought into a room or the room temperature goes up quickly, dew condensation may occur on the interior and exterior surfaces of the monitor. In that case, do not turn the monitor on. Instead wait until the dew condensation disappears, otherwise it may cause some damage to the monitor.

(Cautions for the Use of the Touch Panel)

- During touch operation

Be careful of the following points. Otherwise, damage may occur to the monitor.

- Do not strongly press, scratch, or poke the panel.
 - Do not touch the panel with hard objects such as ballpoint pens or metals.
-

Cleaning

ATTENTION

- Chemicals such as alcohol and antiseptic solution may cause gloss variation, tarnishing, and fading of the panel, and also quality deterioration of the image.
 - Never use any thinner, benzene, wax, and abrasive cleaner, which may damage the panel.
 - Do not allow liquid to enter the clearance between the panel and the panel frame.
-

NOTE

- The optional ScreenCleaner is recommended for cleaning the panel surface.
-

If necessary, the stains on the panel surface can be removed by moistening part of a soft cloth with water.

To use the monitor comfortably

- An excessively dark or bright screen may affect your eyes. Adjust the brightness of the monitor according to the environmental conditions.
- Staring at the monitor for a long time tires your eyes. Take a 10-minute rest every hour.

CONTENTS

Cover	1
 PRECAUTIONS	3
Notice for this monitor	5
CONTENTS	7
Chapter 1 Introduction	8
1-1. Features	8
1-2. Package Contents	8
Chapter 2 Assembly	9
Chapter 3 Settings and Adjustments	14
3-1. Buttons	14
3-2. Basic Operation and Functions	15
Chapter 4 Troubleshooting	18
Chapter 5 Reference	20
5-1. Specifications	20
5-2. Glossary	24
5-3. Preset Timing	25
LIMITED WARRANTY	26

Chapter 1 Introduction

Thank you very much for choosing an EIZO color LCD monitor.

1-1. Features

- FDX1001T/FDV1001T: 10.4-inch screen, FDX1201T: 12.1-inch screen
- Resolution
 - FDX1001T/FDX1201T: XGA (1024 × 768) display compliant
 - FDV1001T: VGA (640 × 480) display compliant
- Maximum brightness
FDX1001T: 460 cd/m², FDV1001T: 350 cd/m², FDX1201T: 780 cd/m²
- LED backlight LCD panel
The LED backlight provides better power efficiency and reduced power consumption compared to existing fluorescent backlight LCD panels.
No mercury, a hazardous substance, is used.
- Analog signal support
PC signal: D-Sub mini 15 pin connector × 1
 - FDX1001T/FDX1201T: Horizontal scanning frequency 24 kHz - 50 kHz
Vertical scanning frequency 55 Hz - 75 Hz
 - FDV1001T: Horizontal scanning frequency 24 kHz - 32 kHz
Vertical scanning frequency 56 Hz - 70.5 HzVideo signal: S-Video/ Video input connector × 1
 - Applicable Format NTSC, PAL, SECAM
- Resistive technology touch panel function
Enables touch operation of the PC screen.
- Crosshair display function
Displays lines (Fine, Circle or Broken Line) as a reference for the position of the image displayed on the monitor. (page 17)
- Video aspect function
Alters the display range of the input image (overscan). (page 17)

1-2. Package Contents

Please contact your local dealer for assistance if any of the listed items are missing or damaged.

NOTE

- Please retain the packing materials for future transport of the monitor.
-

- LCD Monitor
- User's Manual (Limited Warranty included)
- Cable Tie
- Mounting Screws (M4 × 12 mm) : 4 pcs
- EIZO LCD Utility Disk (CD-ROM)*¹
- RS-232C Cable
- Metal Panel Fittings: 4 pcs. (Panel mount type only)

*¹ The disk includes the touch panel driver.

For how to install the touch panel driver, see the Touch Panel Driver User's Manual (on the CD-ROM).

Chapter 2 Assembly

ATTENTION

- Before mounting the monitor into the enclosure, please perform all settings and adjustments. Please refer to the Touch Panel Driver User's Manual (on the CD-ROM) when installing the touch panel driver. For information on how to apply settings and adjustments, please refer to "Chapter 3 Settings and Adjustments".

Chassis mount type

• Exterior view

FDX1001T / FDV1001T

unit : mm (inch)

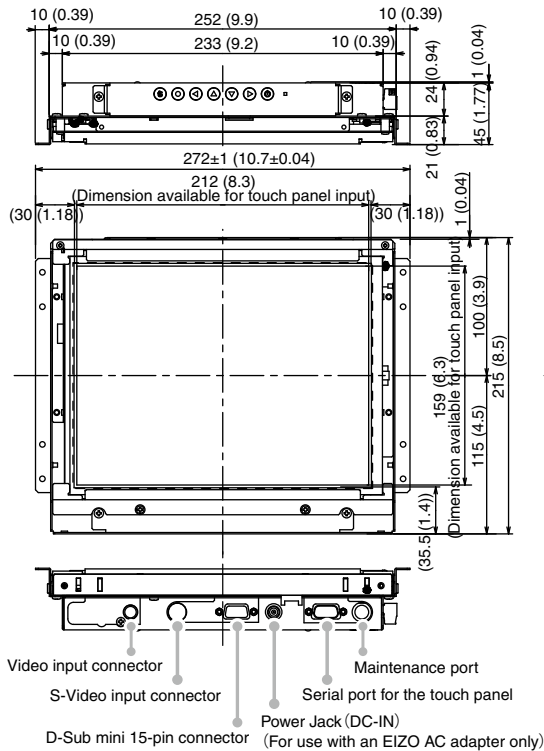

DC power terminal block
Power specifications:
see *1 in the next page

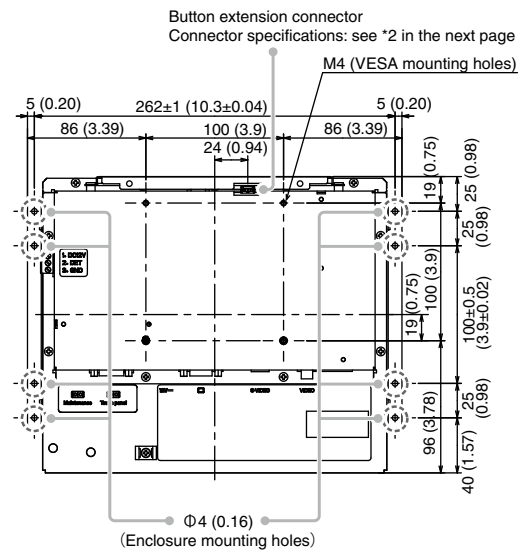

FDX1201T

unit : mm (inch)

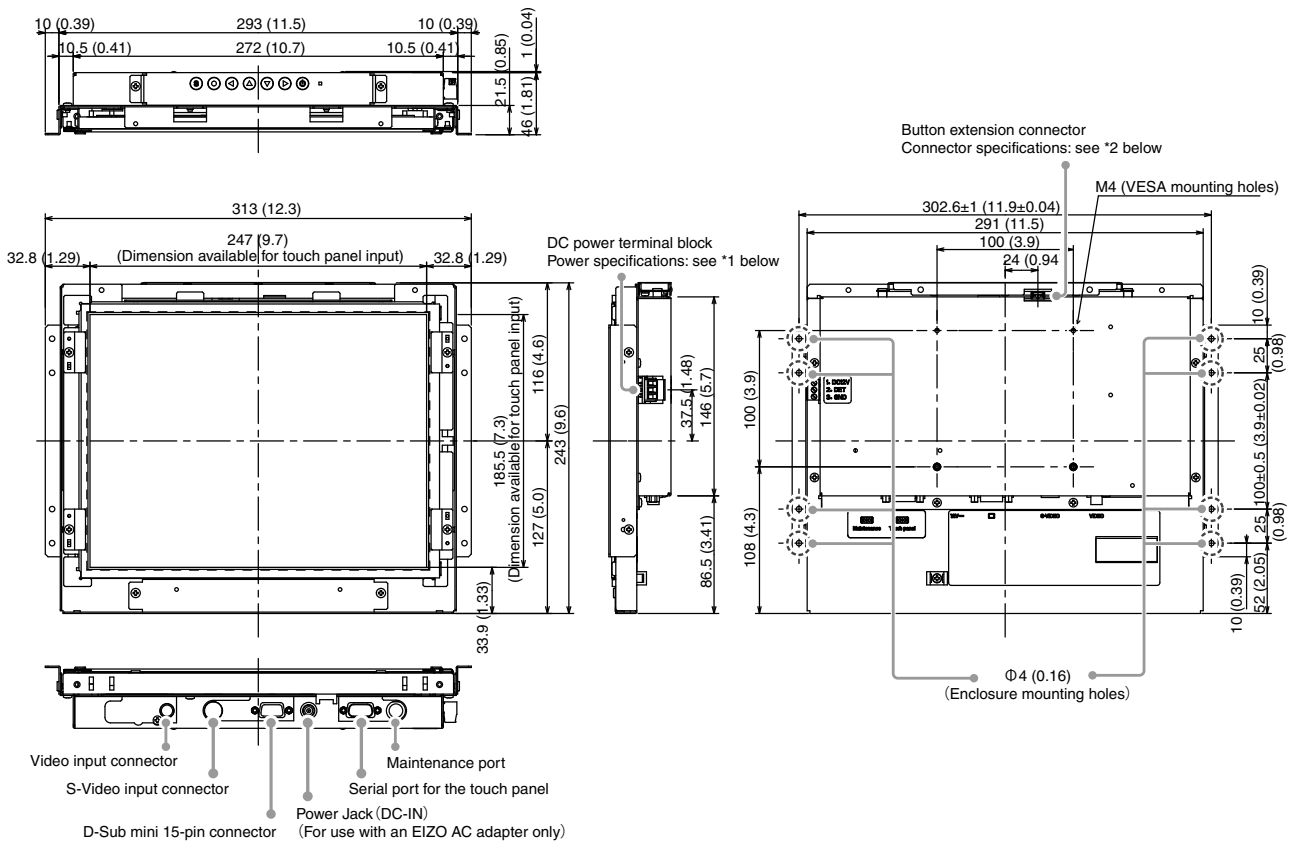

*1 DC power terminal block

Connector Pin Assignment

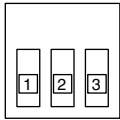

Pin No.	Signal
1	DC12V
2	DET*
3	Ground

* Not connected

Power sequencing

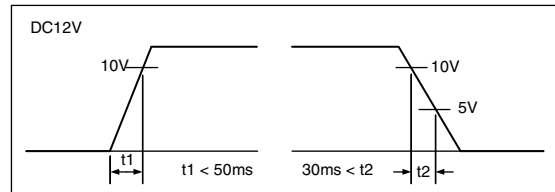

*2 Button extension connector: S3B-PH-SM4-TB(LF)(SN) (JST)

Connector Pin Assignment

Pin No.	Signal
1	KEY0
2	KEY1
3	Ground

• How to assemble

1. Fasten screws through the mounting holes shown in the figure above (4 each on the left and right sides) into the enclosure.

ATTENTION

- Please prepare screws that have a diameter of 3 mm and are suitable for use with the enclosure. (Screws are not included with the monitor.)

Panel mount type

- Exterior view

FDX1001T / FDV1001T

unit : mm (inch)

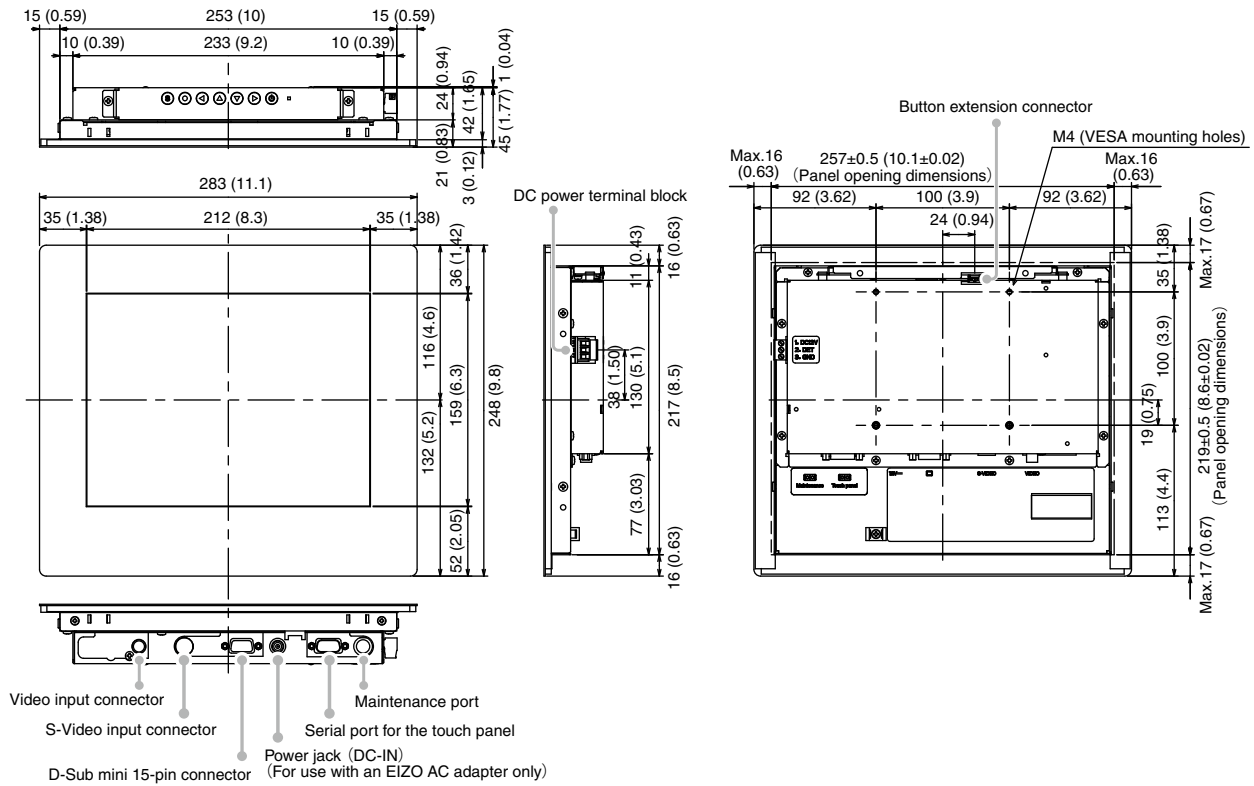

FDX1201T

unit : mm (inch)

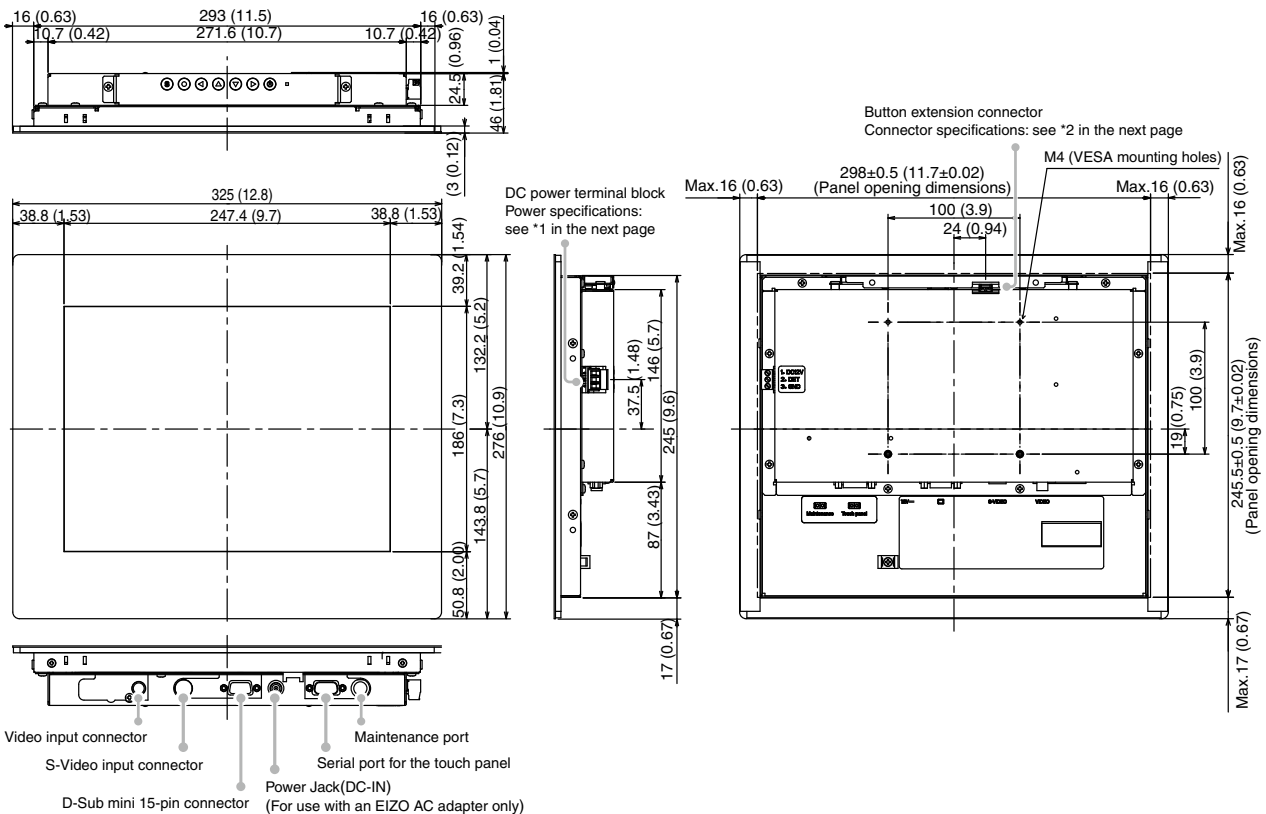

*1 DC power terminal block

Connector Pin Assignment

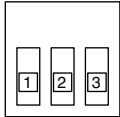

Pin No.	Signal
1	DC12V
2	DET*
3	Ground

* Not connected

Power sequencing

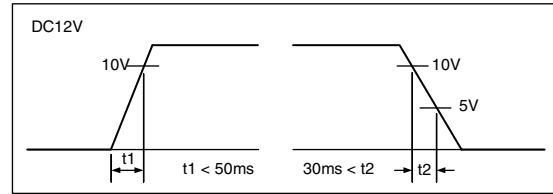

*2 Button extension connector:S3B-PH-SM4-TB(LF)(SN) (JST)

Connector Pin Assignment

Pin No.	Signal
1	KEY0
2	KEY1
3	Ground

● **How to assemble**

ATTENTION

- Since the panel mounted on the monitor is tightened with a metal panel fitting screw, please make the selection considering the following points.
 - Flat
 - A thickness of 5 mm
 - A structure having the strength to support fixing with the screw.

1. Insert the monitor into the mount opening from the front.

The dimensions of a fitting opening are the “Panel opening dimensions” shown in the figure above.

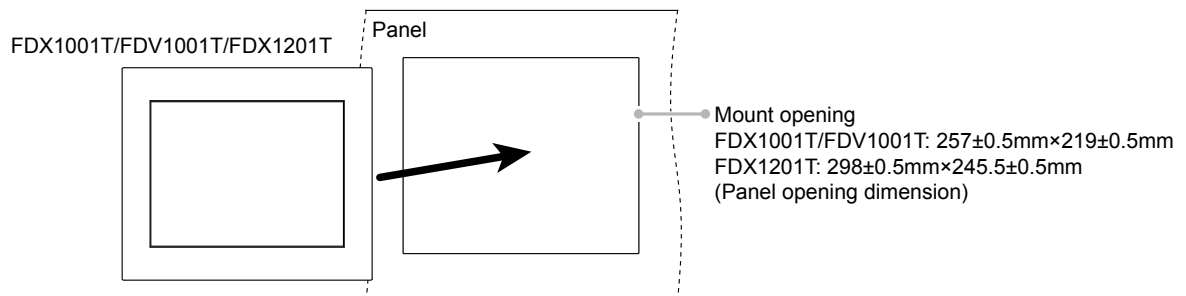

2. Fit the included metal panel fittings onto the monitor (4 locations).

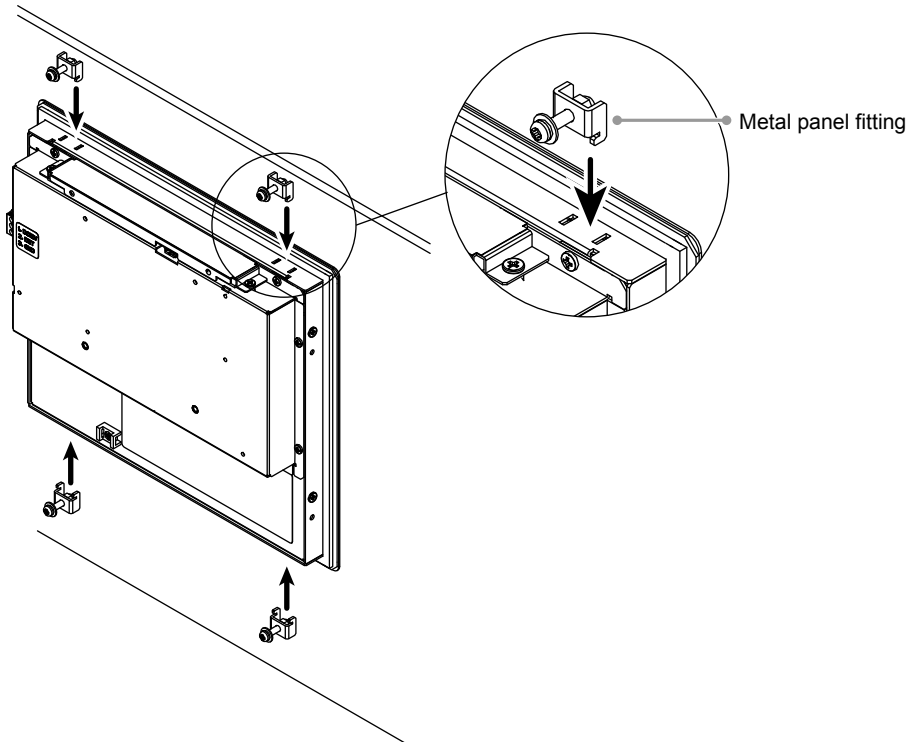

3. Tighten the screws of the metal panel fittings with a prescribed torque of 0.6-0.7 N·m.

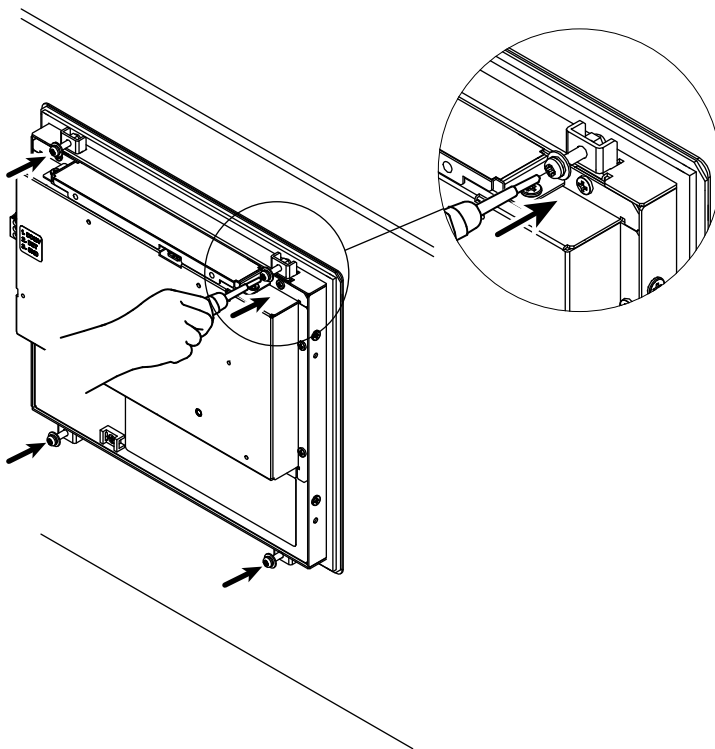

Chapter 3 Settings and Adjustments

3-1. Buttons

Chassis mount type

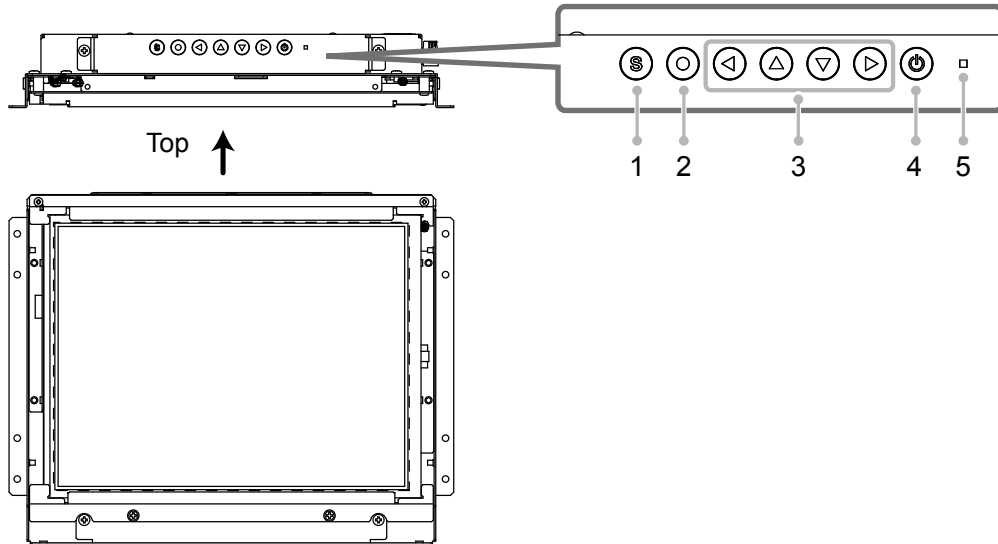

Panel mount type

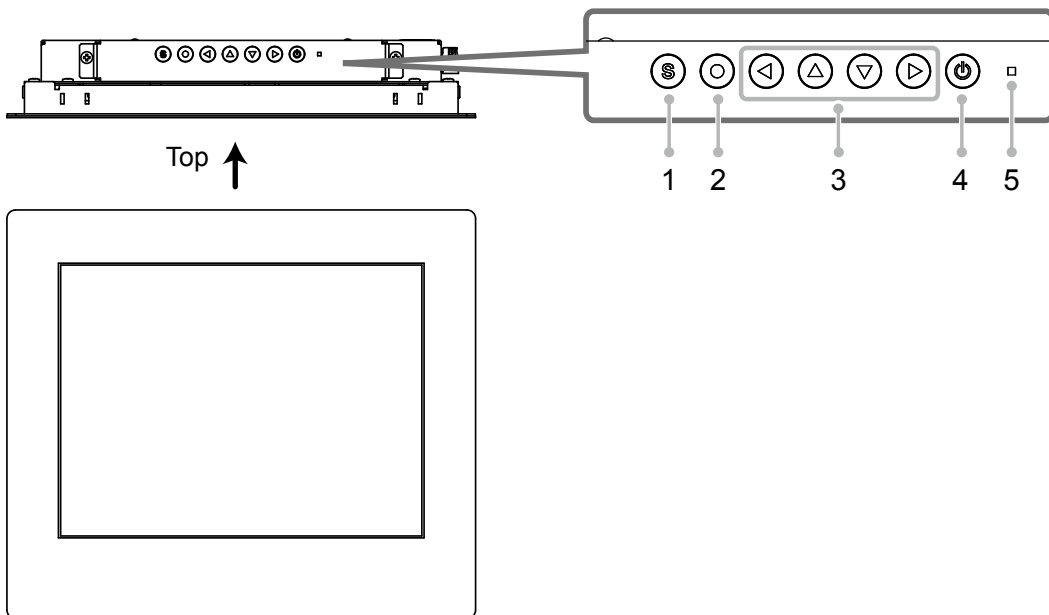

1	Ⓢ button	Switches the input signal.
2	Ⓞ button	Displays the Setting menu, fixes the setting or adjustment items on each menu, and saves the setting or adjustment results.
3	⏪⏩⏴⏵ button	<ul style="list-style-type: none"> Used to select the setting or adjustment items, or to increase or decrease the adjustment values on each menu. When the settings menu is not displayed, pressing ⏴ or ⏵ switches between displaying and not displaying the crosshair.
4	⏻ button	Turns the power on or off.
5	Power indicator	Indicates monitor's operation status. Blue: Operating Orange: Power off



3-2. Basic Operation and Functions

Basic operation of Setting menu



1 Displaying Setting Menu

Press .

2 Setting/Adjusting

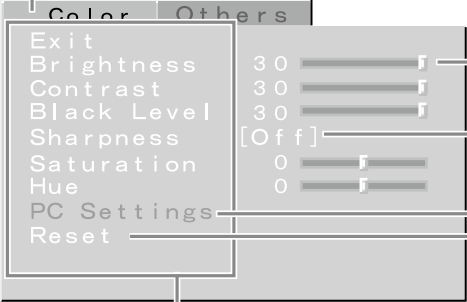
When a tab is selected (highlighted in yellow), press  or  to switch tabs.







Select a setting or adjustable item with  or , and press .

Pressing  on [Reset] will reset all the currently displayed settings to the default configuration.



1 Press .





2 Select "Execute" in the confirmation dialog box, and press .



Pressing  ,  or  on an item with a numerical value brings up an adjustment menu. (The Setting menu disappears when the adjustment menu is displayed.)



Adjust with  or , and press .

Pressing  on an item with a setting value brings up a selection menu.



Select a setting value with  or , and press .

Pressing  on an item without a setting value brings up a more detailed Setting menu.

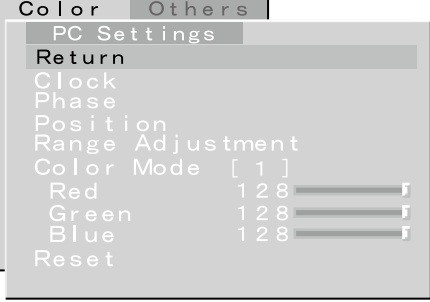

When done configuring the various items, choose [Return], and press  to return to the previous menu.

3 Exiting

Choose [Exit] with  or , and press .

NOTE

- Keeping  pressed for 2 seconds will also exit the Setting menu.

Functions









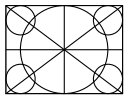
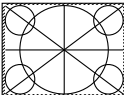
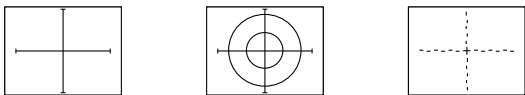

The settings adjustable in the Setting menu are as shown below. The availability of items depends on the input signal.

√ : Configurable — : Not configurable

Tab	Setting / adjustable item	Setting / adjustable value	PC	Video	Setting / adjustable content	
Color	Brightness	0 - 30	√	√	Adjusts the brightness of the backlight.	
	Contrast	0 - 30	√	√	Adjusts the contrast.	
	Black Level	0 - 30	√	√	Adjusts the image brightness.	
	Sharpness	Off/Low/High	—	√	Adjusts the image outlines.	
	Saturation	-30 - +30	—	√	Adjusts the saturation.	
	Hue	-30 - +30	—	√	Adjusts the hue.	
	PC Settings* ¹	Clock		√	—	Adjust this when vertical bars appear.
		Phase		√	—	Adjust this when the screen appears to flicker or blur.
		Position		√	—	Adjust this when the display positioning is misaligned.
		Range Adjustment		√	—	Provides automatic adjustment when you want every color gradients displayed.
		Color Mode* ²	1/2/3	√	—	Select Color Mode (1/2/3) to adjust the colors of red, green and blue in several modes.
		Red/ Green/ Blue	0 - 128	√	—	
	Reset			√	—	Resets the state adjusted with [PC Settings] to the factory default.
Reset			√	√	Resets the state adjusted with the [Color] tab to the factory default (excluding [PC Settings]).	

*¹ This setting becomes available when a PC is connected to the monitor. Please adjust with a PC when display and color adjustments are required.

*² Perform [Range Adjustment] before adjusting Color Mode.

Tab	Setting / adjustable item	Setting / adjustable value	PC	Video	Setting / adjustable content	
Others	Video Aspect	Normal/100%	—	√	<p>Configures the display range of the input image (overscan).</p> <p>“Normal” : Displays the input image with the outmost parts slightly cut off.  * This is how display devices normally display images.</p> <p>“100%” : Displays most of the input image.  * Because a part of the image which normally gets cut off is displayed as well, noise may be visible around the outmost parts, depending on the input signal.</p>	
	Power Save	Disable/Enable	√	√	Automatically turns off the power supply if no video signal has been received for 15 minutes during PC or video viewing.	
	Reverse	Off/On	√	√	Displays the image upside down (180 degree rotation).	
	Crosshair	Off/Fine/Circle/ Broken Line	√	√	<p>Displays a crosshair as a reference for the position of the image.</p> <p>“Fine” “Circle” “Broken Line”</p>  <p>(When the settings menu is not displayed, pressing  or  switches between displaying and not displaying the crosshair.)</p>	
		Color	When “Fine” is selected: Black/White/ Red/Green When “Circle” or “Broken Line” is selected: Black/White	√	√	Configures the color of the crosshair.
		Width	Narrow/Wide	√	√	Configures the thickness of the crosshair’s lines.
		Beep	Off/On	√	√	<p>Sets button press sounds and connection error sounds to on or off.</p> <ul style="list-style-type: none"> • Short beep : - When  ,  or  is pressed. - When an item is selected with . - When a maximum or minimum value is set with  or . • Long beep : When registration is performed with . • 2 short beeps : When the Setting menu is displayed and  is pressed. • 4 short beeps : - When there is no input signal. - When a frequency out of the specified range is received.
		Language	日本語 /English	√	√	Configures the displayed Setting menu and message language.
		Touch Panel	PC+VIDEO/PC/ VIDEO	√	√	Select an input that enables touch panel operation.
		Information		√	√	Reviews the input signals, usage time and model name.



Chapter 4 Troubleshooting

If a problem still remains after applying the suggested remedies, contact your local dealer.

Common

Problems	Possible cause and remedy
No picture <ul style="list-style-type: none"> Power indicator does not light. 	<ul style="list-style-type: none"> Check whether the power cord is connected correctly. If the problem persists, turn off the power, and then turn it on again a few minutes later.
<ul style="list-style-type: none"> Power indicator lights orange. 	<ul style="list-style-type: none"> Press .
<ul style="list-style-type: none"> Power indicator lights blue. 	<ul style="list-style-type: none"> Check whether the power of the connected device is turned on. Switch the input signal. Set each adjusting value in [Brightness] and [Contrast] to higher level. (see page 16)
The screen is too bright or too dark.	<ul style="list-style-type: none"> Adjust using [Brightness] or [Contrast]. (The LCD monitor backlight has a fixed life span. When the screen becomes dark or begins to flicker, contact your local dealer.) (see page 16)
Green/red/blue/white dots or defective dots remain on the screen.	<ul style="list-style-type: none"> This is due to LCD panel characteristics and is not a failure.
Interference patterns or pressure marks remain on the screen.	<ul style="list-style-type: none"> Leave the monitor with a white or black screen. The symptom may disappear.
Afterimages appear.	<ul style="list-style-type: none"> Afterimages are particular to LCD monitors. Avoid displaying the same image for a long time. When displaying the same image for extended periods of time, please set up the screen saver and/or make use of the power saving function.

When displaying on a PC screen

Problems	Possible cause and remedy
The message below appears. <ul style="list-style-type: none"> This message appears when no signal is input. 	<ul style="list-style-type: none"> This message appears when the signal is not input correctly even when the monitor functions properly. The message shown left may appear, because some PCs do not output the signal soon after power-on. Check whether the PC is turned on. Check whether the signal cable is connected properly.
<ul style="list-style-type: none"> The message shows that the input signal is out of the specified frequency range. 	<ul style="list-style-type: none"> Check whether the signal setting of your PC matches the resolution and the vertical frequency settings for the monitor. (see page 20, 21, 22) (Current input signal can be checked in [Information].) Reboot the PC. Select an appropriate display mode using the graphics board's utility. Refer to the manual of the graphics board for details.
Display position is incorrect.	<ul style="list-style-type: none"> Adjust image position using [Position]. (see page 16)
Vertical bars appear on the screen or a part of the image is flickering.	<ul style="list-style-type: none"> Adjust using [Clock]. (see page 16)
Whole screen is flickering or blurring.	<ul style="list-style-type: none"> Adjust using [Phase]. (see page 16)
Characters are blurred.	<ul style="list-style-type: none"> This may occur when a non-complying high-resolution signal is input. Check the PC settings and change the resolution which complies with the monitor.

Touch panel problems

Problems	Possible cause and remedy
Cursor position is not correct. / Cursor jumps.	<ul style="list-style-type: none">• Turn off and on the monitor. If the symptom is not improved, perform the calibration on the monitor.• Touch with one finger only.• Connect the monitor to the PC with the cable indicated in the User's Manual of the monitor. Using a conversion adapter, the touch panel may not operate properly.
Touch operation is not effective.	<ul style="list-style-type: none">• Check whether "Use EEPROM" in the [Device] menu is not checked in the [Properties] settings of the touch panel driver. If the check is already applied, perform the calibration.• Other login user may have changed the setting. Set the touch panel driver again.• Restart "DMC Touch Panel Configuration", or reboot the PC.
Some deflection may appear on the surface of touch panel portion.	<ul style="list-style-type: none">• Due to the touch panel structural characteristics, the deflection may occur on the touch panel surface in high temperature/high humidity operating environment. This is not a trouble.
No touch-sound.	<ul style="list-style-type: none">• The touch-sound may not be output from the external line out of the PC depending on the hardware configuration.• Under Windows 7, touch-sound is only output through the audio output terminal of the PC. To hear touch-sound, connect speakers.

Chapter 5 Reference

5-1. Specifications

FDX1001T

LCD Panel	Size	10.4-inch (260 mm) TFT color LCD
	Surface treatment	Anti-glare
	Surface hardness	2H
	Viewing angle	Horizontal 160°, Vertical 130° (CR : 10 or more)
	Dot Pitch	0.2055 mm
Display Area (H × V)		210.4 mm × 157.8 mm
Resolution		1024 dots × 768 lines
Max. Display Color		Approx. 16.7 million colors
PC input	Horizontal Scan Frequency	24-50 kHz
	Vertical Scan Frequency	55-75 Hz (Non-interlace)
	Max. Dot Clock	65 MHz
	Input Signal Connector	D-Sub mini 15-pin × 1
	Input Signal (Sync)	Separate, TTL, positive / negative
	Input Signal (Video)	Analog, Positive (0.7Vp-p/75Ω)
	Max. Video Signal Memory	15 (preset : 13)
	Plug and Play	VESA DDC 2B/EDID structure 1.3
	Touch Panel	OS: Microsoft Windows 7 Service Pack 1 (32 bit/64 bit) Microsoft Windows Vista Service Pack 2 (32 bit) Microsoft Windows XP Service Pack 3 (32 bit) (Not compatible with Mac OS) Communication protocol : RS-232C serial Detective method : Analog resistive technology
Video input	Applicable Format	NTSC, PAL, SECAM
	Input Signal Connector	S-Video DIN mini 4 pin/ Video Pin jack × 1
	Input Signal Level	S-Video DIN mini 4 pin : Y 1.0Vp-p/75Ω, C 0.28Vp-p/75Ω Video Pin jack : 1.0Vp-p/75Ω
Power Supply		12VDC±10%, 0.9 A
Power Consumption	Screen Display On	11 W or less
	Power Off	0.5 W or less
Dimensions (Width) × (Height) × (Depth)	Chassis mount type	272 mm (10.7 inch) × 215 mm (8.5 inch) × 45 mm (1.77 inch) (excluding the projection)
	Panel mount type	283 mm (11.1 inch) × 248 mm (9.8 inch) × 45 mm (1.77 inch) (excluding the projection)
Mass	Chassis mount type	Approx. 2.2 kg (4.9 lbs.)
	Panel mount type	Approx. 2.5 kg (5.5 lbs.)

Environmental Conditions	Temperature	[Operating temperature] 0 °C - 50 °C (32 °F - 122 °F) [Storage temperature] -20 °C - 60 °C (-4 °F - 140 °F)
	Humidity	[Operating humidity] 20% - 90% R.H. (wet bulb temperature ≤ 39 °C (102 °F), no condensation) [Storage humidity] 10% - 90% R.H. (wet bulb temperature ≤ 39 °C (102 °F), no condensation)
	Pressure	[Operating] 700 hPa - 1060 hPa [Storage] 200 hPa - 1060 hPa

FDV1001T

LCD Panel	Size	10.4-inch (260 mm) TFT color LCD
	Surface treatment	Anti-glare
	Surface hardness	2H
	Viewing angle	Horizontal 160°, Vertical 140° (CR : 10 or more)
	Dot Pitch	0.33 mm
Display Area (H × V)		211.2 mm × 158.4 mm
Resolution		640 dots × 480 lines
Max. Display Color		Approx. 16.2 million colors
PC input	Horizontal Scan Frequency	24-32 kHz
	Vertical Scan Frequency	56-70.5 Hz (Non-interlace)
	Max. Dot Clock	31 MHz
	Input Signal Connector	D-Sub mini 15-pin × 1
	Input Signal (Sync)	Separate, TTL, positive / negative
	Input Signal (Video)	Analog, Positive (0.7Vp-p/75Ω)
	Max. Video Signal Memory	10 (preset : 8)
	Plug and Play	VESA DDC 2B/EDID structure 1.3
	Touch Panel	OS: Microsoft Windows 7 Service Pack 1 (32 bit/64 bit) Microsoft Windows Vista Service Pack 2 (32 bit) Microsoft Windows XP Service Pack 3 (32 bit) (Not compatible with Mac OS) Communication protocol : RS-232C serial Detective method : Analog resistive technology
Video input	Applicable Format	NTSC, PAL, SECAM
	Input Signal Connector	S-Video DIN mini 4 pin/ Video Pin jack × 1
	Input Signal Level	S-Video DIN mini 4 pin : Y 1.0Vp-p/75Ω, C 0.28Vp-p/75Ω Video Pin jack : 1.0Vp-p/75Ω
Power Supply		12VDC±10%, 0.7 A
Power Consumption	Screen Display On	9 W or less
	Power Off	0.5 W or less
Dimensions (Width) × (Height) × (Depth)	Chassis mount type	272 mm (10.7 inch) × 215 mm (8.5 inch) × 45 mm (1.77 inch) (excluding the projection)
	Panel mount type	283 mm (11.1 inch) × 248 mm (9.8 inch) × 45 mm (1.77 inch) (excluding the projection)

Mass	Chassis mount type	Approx. 2.0 kg (4.4 lbs.)
	Panel mount type	Approx. 2.3 kg (5.1 lbs.)
Environmental Conditions	Temperature	[Operating temperature] 0 °C - 50 °C (32 °F - 122 °F) [Storage temperature] -20 °C - 60 °C (-4 °F - 140 °F)
	Humidity	[Operating humidity] 20% - 90% R.H. (wet bulb temperature ≤ 39 °C (102 °F), no condensation) [Storage humidity] 10% - 90% R.H. (wet bulb temperature ≤ 39 °C (102 °F), no condensation)
	Pressure	[Operating] 700 hPa - 1060 hPa [Storage] 200 hPa - 1060 hPa

FDX1201T

LCD Panel	Size	12.1-inch (310 mm) TFT color LCD
	Surface treatment	Anti-glare
	Surface hardness	2H
	Viewing angle	Horizontal 160°, Vertical 140° (CR : 10 or more)
	Dot Pitch	0.240 mm
Display Area (H × V)		245.76 mm × 184.32 mm
Resolution		1024 dots × 768 lines
Max. Display Color		Approx. 16.7 million colors
PC input	Horizontal Scan Frequency	24-50 kHz
	Vertical Scan Frequency	55-75 Hz (Non-interlace)
	Max. Dot Clock	65 MHz
	Input Signal Connector	D-Sub mini 15-pin × 1
	Input Signal (Sync)	Separate, TTL, positive / negative
	Input Signal (Video)	Analog, Positive (0.7Vp-p/75Ω)
	Max. Video Signal Memory	15 (preset : 13)
	Plug and Play	VESA DDC 2B/EDID structure 1.3
	Touch Panel	OS: Microsoft Windows 7 Service Pack 1 (32 bit/64 bit) Microsoft Windows Vista Service Pack 2 (32 bit) Microsoft Windows XP Service Pack 3 (32 bit) (Not compatible with Mac OS) Communication protocol : RS-232C serial Detective method : Analog resistive technology
Video input	Applicable Format	NTSC, PAL, SECAM
	Input Signal Connector	S-Video DIN mini 4 pin/ Video Pin jack × 1
	Input Signal Level	S-Video DIN mini 4 pin : Y 1.0Vp-p/75Ω, C 0.28Vp-p/75Ω Video Pin jack : 1.0Vp-p/75Ω
Power Supply		12VDC±10%, 1.4 A
Power Consumption	Screen Display On	17 W or less
	Power Off	0.8 W or less

Dimensions (Width) × (Height) × (Depth)	Chassis mount type	313 mm (12.3 inch) × 243 mm (9.6 inch) × 46 mm (1.81 inch) (excluding the projection)
	Panel mount type	325 mm (12.8 inch) × 276 mm (10.9 inch) × 46 mm (1.81 inch) (excluding the projection)
Mass	Chassis mount type	Approx. 2.5 kg (5.5 lbs.)
	Panel mount type	Approx. 3.1 kg (6.8 lbs.)
Environmental Conditions	Temperature	[Operating temperature] 0 °C - 50 °C (32 °F - 122 °F) [Storage temperature] -20 °C - 60 °C (-4 °F - 140 °F)
	Humidity	[Operating humidity] 20% - 90% R.H. (wet bulb temperature ≤ 39 °C (102 °F), no condensation) [Storage humidity] 10% - 90% R.H. (wet bulb temperature ≤ 39 °C (102 °F), no condensation)
	Pressure	[Operating] 700 hPa - 1060 hPa [Storage] 200 hPa - 1060 hPa

Connector Pin Assignment

- D-Sub mini 15-pin connector

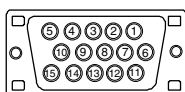

Pin No.	Signal	Pin No.	Signal	Pin No.	Signal
1	Red video	6	Red video ground	11	NC*
2	Green video	7	Green video ground	12	Data (SDA)
3	Blue video	8	Blue video ground	13	H. Sync
4	NC*	9	NC*	14	V. Sync
5	Ground	10	Ground	15	Clock (SCL)

(NC*: No Connection)

- Serial port for the touch panel

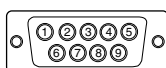

Pin No.	Signal	Pin No.	Signal
1	DCD	6	DSR
2	RXD	7	RTS
3	TXD	8	CTS
4	DTR	9	RI
5	Ground		

5-2. Glossary

Afterimage

The Afterimage is particular to LCD monitors. When the monitor screen is left on for a long period without use. The Afterimage can be removed gradually by changing the displayed image.

Clock

The analog input monitor needs to reproduce a clock of the same frequency as the dot clock of the graphics system in use, when the analog input signal is converted to a digital signal for image display. This is called clock adjustment. If the clock pulse is not set correctly, some vertical bars appear on the screen.

Phase

Phase means the sampling timing to convert the analog input signal to a digital signal. Phase adjustment is made to adjust the timing. It is recommended that phase adjustment be made after the clock is adjusted correctly.

Range Adjustment

Range adjustment controls the signal output levels to display every color gradation. It is recommended that range adjustment be made before color adjustment.

Resolution

The LCD panel consists of numerous pixels of specified size, which are illuminated to form images. This monitor consists of 1024 (FDX1001T/FDX1201T) / 640 (FDV1001T) horizontal pixels and 768 (FDX1001T/FDX1201T) / 480 (FDV1001T) vertical pixels.

At a resolution of 1024×768 (FDX1001T/FDX1201T) / 640×480 (FDV1001T), all pixels are illuminated as a full screen (1:1).

5-3. Preset Timing

The following table shows the factory preset video timing of the PC.

ATTENTION

- Display position may be deviated depending on the PC connected, which may require screen adjustment using Setting menu.
- If a signal other than those listed in the table is input, adjust the screen using the Setting menu. However, screen display may still be incorrect even after the adjustment.
- When interlace signals are used, the screen cannot be displayed correctly even after screen adjustment using the Setting menu.

FDX1001T/FDX1201T

Resolution	Applicable signal	Frequency			Polarity	
		Dot clock : MHz	Horizontal : kHz	Vertical : Hz	Horizontal	Vertical
720 × 400	VGA TEXT	28.33	31.47	70.09	Negative	Positive
640 × 480	VGA	25.18	31.47	59.94	Negative	Negative
640 × 480	VESA	31.50	37.86	72.81	Negative	Negative
640 × 480	VESA	31.50	37.50	75.00	Negative	Negative
800 × 600	VESA	36.00	35.16	56.25	Positive	Positive
800 × 600	VESA	40.00	37.88	60.32	Positive	Positive
800 × 600	VESA	50.00	48.08	72.19	Positive	Positive
800 × 600	VESA	49.50	46.88	75.00	Positive	Positive
1024 × 768	VESA	65.00	48.36	60.00	Negative	Negative
640 × 480	MAC	30.24	35.00	66.67	Negative	Negative
832 × 624	MAC	57.28	49.72	74.55	Negative	Negative
640 × 400	PC-9801	21.05	24.83	56.42	Negative	Negative
640 × 400	PC-9821 AP2	25.18	31.48	70.10	Negative	Negative

FDV1001T

Resolution	Applicable signal	Frequency			Polarity	
		Dot clock : MHz	Horizontal : kHz	Vertical : Hz	Horizontal	Vertical
720 × 400	VGA TEXT	28.33	31.47	70.09	Negative	Positive
640 × 480	VGA	25.18	31.47	59.94	Negative	Negative
800 × 600	VESA	36.00	35.16	56.25	Positive	Positive
800 × 600	VESA	40.00	37.88	60.32	Positive	Positive
1024 × 768	VESA	65.00	48.36	60.00	Negative	Negative
640 × 480	MAC	30.24	35.00	66.67	Negative	Negative
640 × 400	PC-9801	21.05	24.83	56.42	Negative	Negative
640 × 400	PC-9821 AP2	25.18	31.48	70.10	Negative	Negative

LIMITED WARRANTY

EIZO Corporation (hereinafter referred to as “EIZO”) and distributors authorized by EIZO (hereinafter referred to as the “Distributors”) warrant, subject to and in accordance with the terms of this limited warranty (hereinafter referred to as the “Warranty”), to the original purchaser (hereinafter referred to as the “Original Purchaser”) who purchased the product specified in this document (hereinafter referred to as the “Product”) from EIZO or Distributors, that EIZO and Distributors shall, at their sole discretion, either repair or replace the Product at no charge if the Original Purchaser becomes aware within the Warranty Period (defined below) that the Product malfunctions or is damaged in the course of normal use of the Product in accordance with the description in the instruction manual attached to the Product (hereinafter referred to as the “User’s Manual”).

The period of this Warranty is two (2) years from the date of purchase of the Product (hereinafter referred to as the “Warranty Period”). EIZO and Distributors shall bear no liability or obligation with regard to the Product in relation to the Original Purchaser or any third parties other than as provided under this Warranty.

EIZO and Distributors will cease to hold or store any parts of the Product upon expiration of seven (7) years after the production of such parts is discontinued. In repairing the monitor, EIZO and Distributors will use renewal parts which comply with our QC standards.

The Warranty is valid only in the countries or territories where the Distributors are located. The Warranty does not restrict any legal rights of the Original Purchaser.

Notwithstanding any other provision of this Warranty, EIZO and Distributors shall have no obligation under this Warranty whatsoever in any of the cases as set forth below:

- (a) Any defect of the Product caused by freight damage, modification, alteration, abuse, misuse, accident, incorrect installation, disaster, faulty maintenance and/or improper repair by third party other than EIZO and Distributors;
- (b) Any incompatibility of the Product due to possible technical innovations and/or regulations;
- (c) Any deterioration of the sensor;
- (d) Any deterioration of display performance caused by the deterioration of expendable parts such as the LCD panel and/or backlight, etc. (e.g. changes in brightness, changes in brightness uniformity, changes in color, changes in color uniformity, defects in pixels including burnt pixels, etc.);
- (e) Any defect of the Product caused by external equipment;
- (f) Any defect of the Product on which the original serial number has been altered or removed;
- (g) Any defect of the Product caused by liquid leaking from battery;
- (h) Any normal deterioration of the product, particularly that of consumables, accessories, and/or attachments (e.g. batteries, buttons, rotating parts, remote control, cables, User’s Manual, etc.); and
- (i) Any deformation, discoloration, and/or warp of the exterior of the product including that of the surface of the LCD panel.

To obtain service under the Warranty, the Original Purchaser must deliver the Product, freight prepaid, in its original package or other adequate package affording an equal degree of protection, assuming the risk of damage and/or loss in transit, to the local Distributor. The Original Purchaser must present proof of purchase of the Product and the date of such purchase when requesting services under the Warranty.

The Warranty Period for any replaced and/or repaired product under this Warranty shall expire at the end of the original Warranty Period.

EIZO OR DISTRIBUTORS ARE NOT RESPONSIBLE FOR ANY DAMAGE TO, OR LOSS OF, DATA OR OTHER INFORMATION STORED IN ANY MEDIA OR ANY PART OF ANY PRODUCT RETURNED TO EIZO OR DISTRIBUTORS FOR REPAIR.

EIZO AND DISTRIBUTORS MAKE NO FURTHER WARRANTIES, EXPRESSED OR IMPLIED, WITH RESPECT TO THE PRODUCT AND ITS QUALITY, PERFORMANCE, MERCHANTABILITY OR FITNESS FOR ANY PARTICULAR USE. IN NO EVENT SHALL EIZO OR DISTRIBUTORS BE LIABLE FOR ANY INCIDENTAL, INDIRECT, SPECIAL, CONSEQUENTIAL OR OTHER DAMAGE WHATSOEVER (INCLUDING, WITHOUT LIMITATION, DAMAGES FOR LOSS OF PROFIT, BUSINESS INTERRUPTION, LOSS OF BUSINESS INFORMATION, OR ANY OTHER PECUNIARY LOSS) ARISING OUT OF THE USE OR INABILITY TO USE THE PRODUCT OR IN ANY CONNECTION WITH THE PRODUCT, WHETHER BASED ON CONTRACT, TORT, NEGLIGENCE, STRICT LIABILITY OR OTHERWISE, EVEN IF EIZO OR DISTRIBUTORS HAVE BEEN ADVISED OF THE POSSIBILITY OF SUCH DAMAGES. THIS EXCLUSION ALSO INCLUDES ANY LIABILITY WHICH MAY ARISE OUT OF THIRD PARTY CLAIMS AGAINST THE ORIGINAL PURCHASER. THE ESSENCE OF THIS PROVISION IS TO LIMIT THE POTENTIAL LIABILITY OF EIZO AND DISTRIBUTORS ARISING OUT OF THIS LIMITED WARRANTY AND/OR SALES.

保証書

(For Japanese Market Only.)

この保証書は所定事項を記入して効力を発するものですから、必ずお買い上げ年月日・販売店・住所・電話番号の記入をご確認ください。

保証期間	お買い上げの日より 2 年間	モデル名 /製造番号	(記入または梱包箱側面に添付のラベルを貼付ください)
お客様	フリガナ お名前	ご住所 〒	
	様	TEL ()	
販売店	お買い上げ年月日 年 月 日		
	住所・店名・TEL・担当者		

保証規定

- 本製品の取扱説明書、本体添付ラベルなどの注意書に従った使用状態で保証期間内に故障した場合、無料で故障箇所の修理または交換をさせていただきますので、保証書を添えてお買い上げの販売店またはEIZOサポートまでお申しつけください。
- 保証期間内でも次のような場合には、有償修理とさせていただきます。
 - 保証書のご提示がない場合
 - 保証書の所定事項が未記入、または字句が書き換えられている場合
 - 使用上の誤り、または不当な修理や改造による故障及び損傷
 - お買い上げの後の輸送・移動・落下などによる故障及び損傷
 - 火災・地震・水害・落雷・その他の天災地変ならびに公害や異常電圧などの外部要因に起因する故障及び損傷
 - 車両・船舶などのような強い振動や衝撃を受ける場所に搭載された場合に生じる故障及び損傷
 - 電池の液漏れによる故障及び損傷
 - 液晶パネル、バックライトの経年劣化(輝度の変化、色の変化、輝度と色の均一性の変化、焼き付き、欠点の増加など)
 - センサーの経年劣化
 - 外装品(液晶パネルの表面を含む)の損傷、変色、劣化
 - 付属品(リモコン、ケーブル、取扱説明書など)の交換
 - 当社指定の消耗品(電池、スイッチ/ボタン/レバー類、回転部など)
 - 技術革新などにより製品に互換性がなくなった場合
- 保証書は日本国内においてのみ有効です。
This warranty is valid only in Japan.
- 保証書は再発行いたしませんので紛失しないよう大切に保管してください。
 - * 保証書は、保証書に明示した期間、条件のもとにおいて無償修理をお約束するものです。なお、保証期間経過後の修理についてご不明な場合はお買い上げの販売店またはEIZOサポートまでお問い合わせください。
 - * 当社では、この製品の補修用性能部品(製品の機能を維持するために必要な部品)を、製品の製造終了後、最低7年間保有しています。補修用性能部品の最低保有期間が経過した後も、故障箇所によっては修理可能な場合がありますので、EIZOサポートにご相談ください。



EIZO株式会社

〒924-8566 石川県白山市下柏野町 153 番地

EIZO Corporation

153 Shimokashiwano, Hakusan, Ishikawa 924-8566 Japan
Phone: +81 76 277 6792 Fax: +81 76 277 6793

<http://www.eizo.co.jp>

<http://www.eizo.com>

EIZO Europe GmbH

Helmut-Grashoff-Strasse 18, 41179 Mönchengladbach, Germany
Phone: +49 2161 8210210 Fax: +49 2161 8210150

艺卓显像技术(苏州)有限公司

中国苏州市苏州工业园区展业路8号中新科技工业坊5B
Phone: +86 512 6252 0100 Fax: +86 512 6252 1508

9th Edition-April, 2013 Printed in Japan.